



Surface Mount PAR[®] Transient Voltage Suppressors

High Temperature Stability and High Reliability Conditions



SMC (DO-214AB)

Cathode  Anode 

LINKS TO ADDITIONAL RESOURCES



PRIMARY CHARACTERISTICS	
V _{WM}	10 V to 43 V
V _{BR}	11.1 V to 52.8 V
P _{PPM}	3000 W
P _D	6.0 W
I _{FSM}	200 A
T _J max.	185 °C
Polarity	Unidirectional
Package	SMC (DO-214AB)

FEATURES

- Junction passivation optimized design passivated anisotropic rectifier technology
- T_J = 185 °C capability suitable for high reliability and automotive requirement
- Available in uni-directional polarity only
- 3000 W peak pulse power capability with a 10/1000 μs waveform
- Excellent clamping capability
- Very fast response time
- Low incremental surge resistance
- Meets MSL level 1, per J-STD-020, LF maximum peak of 260 °C
- AEC-Q101 qualified available
- Automotive ordering code: base P/NHE3 or P/NHM3
- Material categorization: for definitions of compliance please see www.vishay.com/doc?99912



TYPICAL APPLICATIONS

Use in sensitive electronics protection against voltage transients induced by inductive load switching and lighting on ICs, MOSFET, signal lines of sensor units for consumer, computer, industrial, automotive, and telecommunication.

MECHANICAL DATA

Case: SMC (DO-214AB)

Molding compound meets UL 94 V-0 flammability rating
 Base P/NHE3_X - RoHS-compliant and AEC-Q101 qualified
 Base P/NHM3_X - halogen-free, RoHS-compliant and AEC-Q101 qualified
 ("X" denotes revision code e.g. A, B, ...)

Terminals: matte tin plated leads, solderable per J-STD-002 and JESD 22-B102

HE3 and HM3 suffix meet JESD 201 class 2 whisker test

Polarity: color band denotes cathode end

MAXIMUM RATINGS (T _A = 25 °C unless otherwise noted)			
PARAMETER	SYMBOL	VALUE	UNIT
Peak pulse power dissipation with a 10/1000 μs waveform ⁽¹⁾ (fig. 3)	P _{PPM}	3000	W
Peak power pulse current with a 10/1000 μs waveform ⁽¹⁾ (fig. 1)	I _{PPM}	See next table	A
Peak forward surge current 8.3 ms single half sine-wave ⁽²⁾	I _{FSM}	200	A
Power dissipation on infinite heatsink, T _L = 75 °C (fig. 6)	P _D	6.0	W
Maximum instantaneous forward voltage at 100 A ⁽²⁾	V _F	3.5	V
Operating junction and storage temperature range	T _J , T _{STG}	-65 to +185	°C

Notes

⁽¹⁾ Non-repetitive current pulse, per fig. 3 and derated above T_A = 25 °C per fig. 2.

⁽²⁾ Measured on 8.3 ms single half sine-wave, or equivalent square wave, duty cycle = 4 pulses per minute maximum



ELECTRICAL CHARACTERISTICS ($T_A = 25\text{ }^\circ\text{C}$ unless otherwise noted)											
DEVICE TYPE	DEVICE MARKING CODE	BREAKDOWN VOLTAGE V_{BR} AT I_T ⁽¹⁾ (V)			TEST CURRENT I_T (mA)	STAND-OFF VOLTAGE V_{WM} (V)	MAXIMUM REVERSE LEAKAGE AT V_{WM} I_R (μA)	MAXIMUM REVERSE LEAKAGE AT V_{WM} I_D (μA) $T_J = 150\text{ }^\circ\text{C}$	MAXIMUM PEAK PULSE SURGE CURRENT I_{PPM} (A) ⁽²⁾	MAXIMUM CLAMPING VOLTAGE AT I_{PPM} V_C (V)	TYPICAL TEMP. COEFFICIENT OF V_{BR} ⁽³⁾ α_T ($\%/^\circ\text{C}$)
		MIN.	NOM.	MAX.							
3KASMC10A	3AX	11.1	11.7	12.3	1.0	10	5.0	50	177	17.0	0.069
3KASMC11A	3AZ	12.2	12.9	13.5	1.0	11	5.0	50	165	18.2	0.072
3KASMC12A	3BE	13.3	14.0	14.7	1.0	12	2.0	20	151	19.9	0.074
3KASMC13A	3BG	14.4	15.2	15.9	1.0	13	2.0	20	140	21.5	0.076
3KASMC14A	3BK	15.6	16.4	17.2	1.0	14	1.0	10	129	23.2	0.078
3KASMC15A	3BM	16.7	17.6	18.5	1.0	15	1.0	10	123	24.4	0.080
3KASMC16A	3BP	17.8	18.8	19.7	1.0	16	1.0	10	115	26.0	0.081
3KASMC17A	3BR	18.9	19.9	20.9	1.0	17	1.0	10	109	27.6	0.082
3KASMC18A	3BT	20.0	21.1	22.1	1.0	18	1.0	10	103	29.2	0.083
3KASMC20A	3BV	22.2	23.4	24.5	1.0	20	1.0	10	92.6	32.4	0.085
3KASMC22A	3BX	24.4	25.7	26.9	1.0	22	1.0	10	84.5	35.5	0.086
3KASMC24A	3BZ	26.7	28.1	29.5	1.0	24	1.0	10	77.1	38.9	0.087
3KASMC26A	3CE	28.9	30.4	31.9	1.0	26	1.0	10	71.3	42.1	0.088
3KASMC28A	3CG	31.1	32.8	34.4	1.0	28	1.0	10	66.1	45.4	0.089
3KASMC30A	3CK	33.3	35.1	36.8	1.0	30	1.0	15	62.0	48.4	0.090
3KASMC33A	3CM	36.7	38.7	40.6	1.0	33	1.0	15	56.3	53.3	0.091
3KASMC36A	3CP	40.0	42.1	44.2	1.0	36	1.0	20	51.6	58.1	0.091
3KASMC40A	3CR	44.4	46.8	49.1	1.0	40	1.0	20	46.5	64.5	0.092
3KASMC43A	3CT	47.8	50.3	52.8	1.0	43	1.0	20	43.2	69.4	0.093

Notes

- (1) Pulse test: $t_p \leq 50\text{ ms}$
- (2) Surge current waveform per fig. 3 and derate per fig. 2
- (3) To calculate V_{BR} vs. junction temperature, use the following formula: V_{BR} at $T_J = V_{BR}$ at $25\text{ }^\circ\text{C} \times (1 + \alpha_T \times (T_J - 25))$
- (4) All terms and symbols are consistent with ANSI/IEEE C62.35

THERMAL CHARACTERISTICS ($T_A = 25\text{ }^\circ\text{C}$ unless otherwise noted)			
PARAMETER	SYMBOL	VALUE	UNIT
Typical thermal resistance, junction to ambient air ⁽¹⁾	$R_{\theta JA}$	77.5	$^\circ\text{C}/\text{W}$
Typical thermal resistance, junction to leads	$R_{\theta JL}$	18.3	

Note

- (1) Mounted on minimum recommended pad layout

ORDERING INFORMATION (Example)				
PREFERRED P/N	UNIT WEIGHT (g)	PREFERRED PACKAGE CODE	BASE QUANTITY	DELIVERY MODE
3KASMC10AHE3_B/H ⁽¹⁾	0.211	H	850	7" diameter plastic tape and reel
3KASMC10AHE3_B/I ⁽¹⁾	0.211	I	3500	13" diameter plastic tape and reel
3KASMC10AHM3_B/H ⁽¹⁾	0.211	H	850	7" diameter plastic tape and reel
3KASMC10AHM3_B/I ⁽¹⁾	0.211	I	3500	13" diameter plastic tape and reel

Note

- (1) AEC-Q101 qualified



RATINGS AND CHARACTERISTICS CURVES ($T_A = 25\text{ }^\circ\text{C}$ unless otherwise noted)

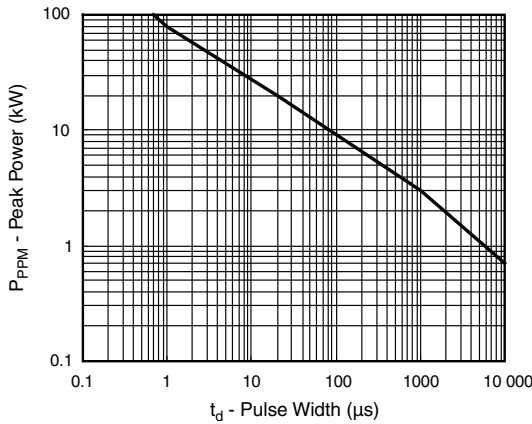

Fig. 1 - Peak Pulse Power Rating Curve

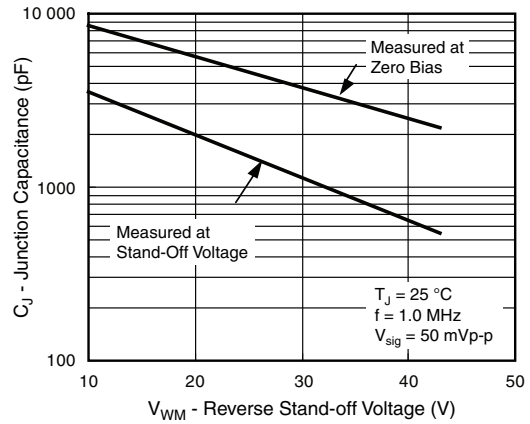

Fig. 4 - Typical Junction Capacitance

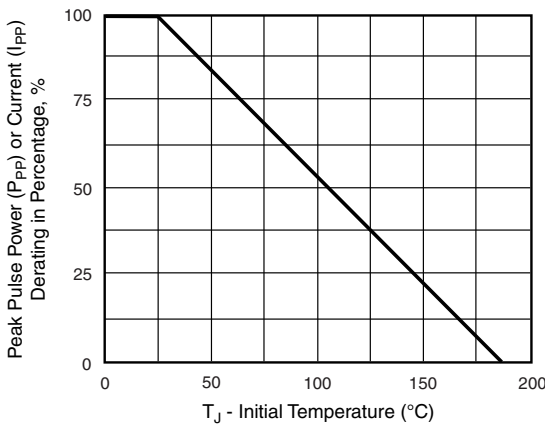

Fig. 2 - Pulse Power or Current vs. Initial Junction Temperature

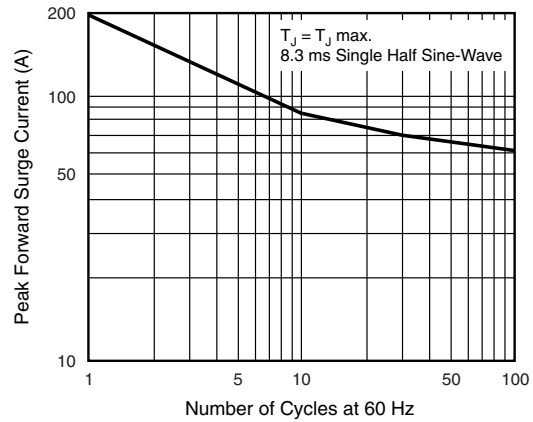

Fig. 5 - Maximum Non-Repetitive/Peak Forward Surge Current

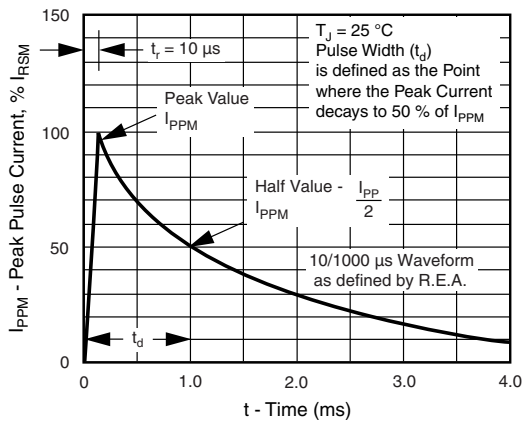

Fig. 3 - Pulse Waveform

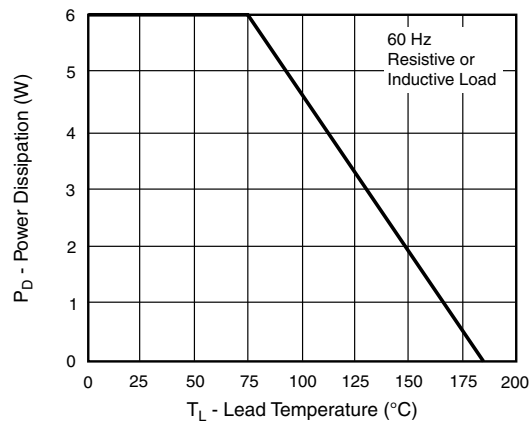
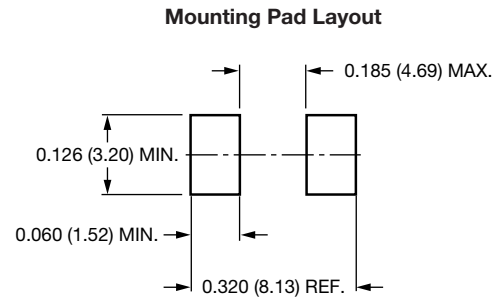
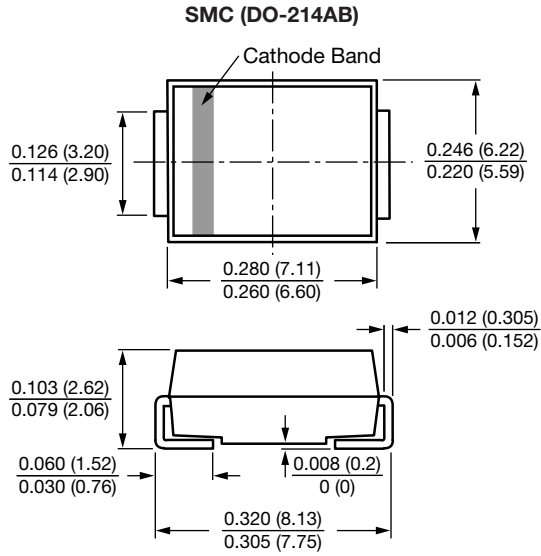

Fig. 6 - Power Derating Curve



PACKAGE OUTLINE DIMENSIONS in inches (millimeters)





Disclaimer

ALL PRODUCT, PRODUCT SPECIFICATIONS AND DATA ARE SUBJECT TO CHANGE WITHOUT NOTICE TO IMPROVE RELIABILITY, FUNCTION OR DESIGN OR OTHERWISE.

Vishay Intertechnology, Inc., its affiliates, agents, and employees, and all persons acting on its or their behalf (collectively, "Vishay"), disclaim any and all liability for any errors, inaccuracies or incompleteness contained in any datasheet or in any other disclosure relating to any product.

Vishay makes no warranty, representation or guarantee regarding the suitability of the products for any particular purpose or the continuing production of any product. To the maximum extent permitted by applicable law, Vishay disclaims (i) any and all liability arising out of the application or use of any product, (ii) any and all liability, including without limitation special, consequential or incidental damages, and (iii) any and all implied warranties, including warranties of fitness for particular purpose, non-infringement and merchantability.

Statements regarding the suitability of products for certain types of applications are based on Vishay's knowledge of typical requirements that are often placed on Vishay products in generic applications. Such statements are not binding statements about the suitability of products for a particular application. It is the customer's responsibility to validate that a particular product with the properties described in the product specification is suitable for use in a particular application. Parameters provided in datasheets and / or specifications may vary in different applications and performance may vary over time. All operating parameters, including typical parameters, must be validated for each customer application by the customer's technical experts. Product specifications do not expand or otherwise modify Vishay's terms and conditions of purchase, including but not limited to the warranty expressed therein.

Hyperlinks included in this datasheet may direct users to third-party websites. These links are provided as a convenience and for informational purposes only. Inclusion of these hyperlinks does not constitute an endorsement or an approval by Vishay of any of the products, services or opinions of the corporation, organization or individual associated with the third-party website. Vishay disclaims any and all liability and bears no responsibility for the accuracy, legality or content of the third-party website or for that of subsequent links.

Except as expressly indicated in writing, Vishay products are not designed for use in medical, life-saving, or life-sustaining applications or for any other application in which the failure of the Vishay product could result in personal injury or death. Customers using or selling Vishay products not expressly indicated for use in such applications do so at their own risk. Please contact authorized Vishay personnel to obtain written terms and conditions regarding products designed for such applications.

No license, express or implied, by estoppel or otherwise, to any intellectual property rights is granted by this document or by any conduct of Vishay. Product names and markings noted herein may be trademarks of their respective owners.