

FES16AT THRU FES16JT

FAST EFFICIENT PLASTIC RECTIFIER

Reverse Voltage - 50 to 600 Volts

Forward Current - 16.0 Amperes

TO-220AC

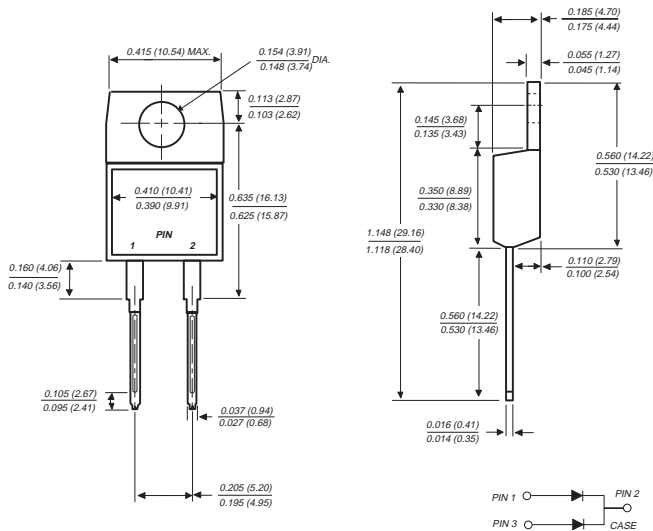

Dimensions in inches and (millimeters)

FEATURES

- ◆ Plastic package has Underwriters Laboratory Flammability Classification 94V-0
- ◆ Glass passivated chip junction
- ◆ Low power loss
- ◆ Low forward voltage, high current capability
- ◆ High surge current capability
- ◆ Superfast recovery time, for high efficiency
- ◆ High temperature soldering guaranteed: 250°C, 0.16" (4.06mm) from case for 10 seconds

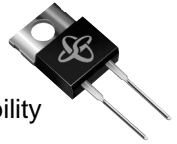

MECHANICAL DATA

Case: JEDEC TO-220AC molded plastic body over passivated chips

Terminals: Plated lead solderable per MIL-STD-750, Method 2026

Polarity: As marked

Mounting Position: Any

Weight: 0.064 ounce, 1.81 grams

MAXIMUM RATINGS AND ELECTRICAL CHARACTERISTICS

Ratings at 25°C ambient temperature unless otherwise specified.

	SYMBOLS	FES 16AT	FES 16BT	FES 16CT	FES 16DT	FES 16FT	FES 16GT	FES 16HT	FES 16JT	UNITS
Maximum repetitive peak reverse voltage	V_{RRM}	50	100	150	200	300	400	500	600	Volts
Maximum RMS voltage	V_{RMS}	35	70	105	140	210	280	350	420	Volts
Maximum DC blocking voltage	V_{DC}	50	100	150	200	300	400	500	600	Volts
Maximum average forward rectified current at $T_C=100^\circ\text{C}$	$I_{(AV)}$	16.0								Amps
Peak forward surge current 8.3ms single half sine-wave superimposed on rated load (JEDEC Method) at $T_C=100^\circ\text{C}$	I_{FSM}	250.0								Amps
Maximum instantaneous forward voltage at 16A	V_F	0.975			1.3		1.5			Volts
Maximum DC reverse current at rated DC blocking voltage	I_R	$T_C=25^\circ\text{C}$ 10.0			$T_C=100^\circ\text{C}$ 500.0					μA
Maximum reverse recovery time (NOTE 1)	t_{rr}	35.0			50.0					ns
Typical junction capacitance (NOTE 2)	C_J				175.0			145.0		pF
Typical thermal resistance (NOTE 3)	$R_{\theta JA}$ $R_{\theta JC}$				16.0 1.2					$^\circ\text{C}/\text{W}$
Operating and storage temperature range	T_J, T_{STG}	-65 to +150								$^\circ\text{C}$

NOTES:

- (1) Reverse recovery test conditions: $I_F=0.5\text{A}$, $I_R=1.0\text{A}$, $I_{rr}=0.25\text{A}$
- (2) Measured at 1.0 MHz and applied reverse voltage of 4.0 Volts
- (3) Thermal resistance from junction to case and ambient mounted on heatsink

RATINGS AND CHARACTERISTICS CURVES FES16AT THRU FES16JT

FIG. 1 - FORWARD CURRENT DERATING CURVE

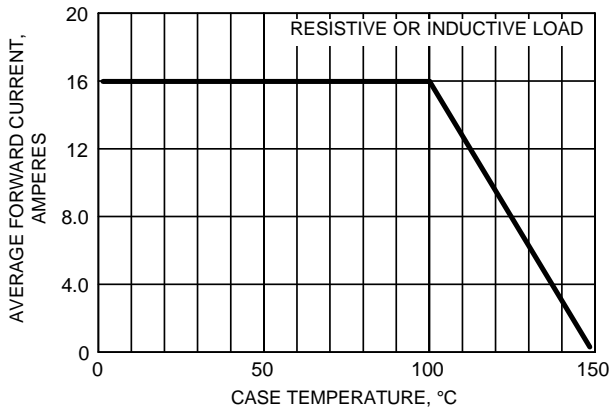

FIG. 2 - MAXIMUM NON-REPETITIVE PEAK FORWARD SURGE CURRENT

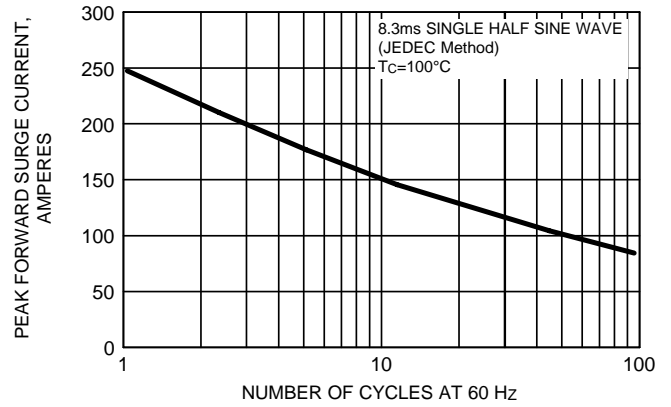

FIG. 4 - TYPICAL INSTANTANEOUS FORWARD CHARACTERISTICS

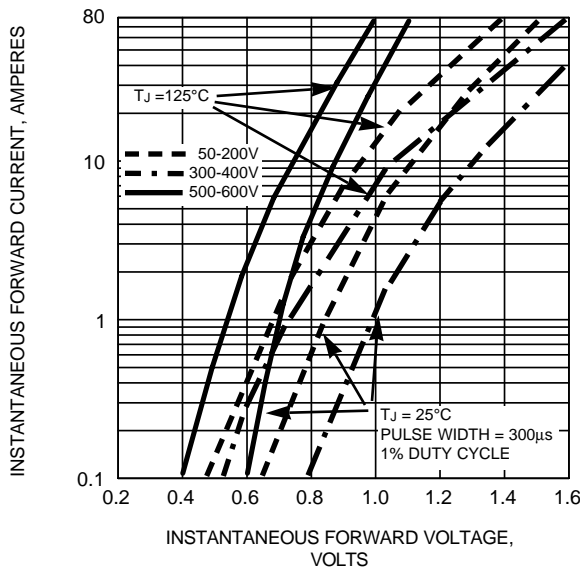

FIG. 3 - TYPICAL REVERSE CHARACTERISTICS

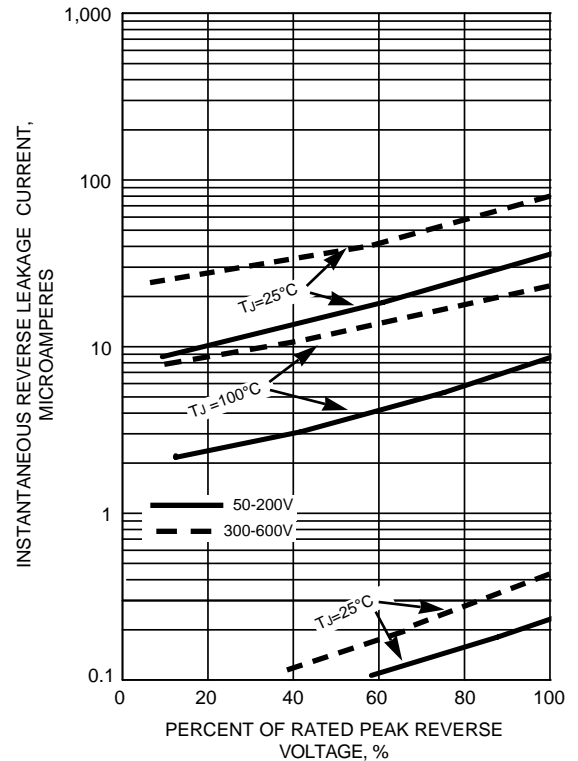
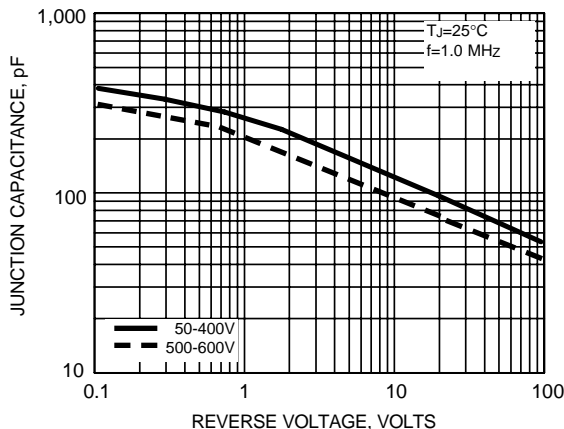

FIG. 5 - TYPICAL JUNCTION CAPACITANCE



单击下面可查看定价，库存，交付和生命周期等信息

[>>Vishay\(威世\)](#)