

Energy Storage Double Layer Capacitors



FEATURES

- Polarized capacitor with high charge density, alternative product to rechargeable backup batteries
- Dielectric: electric double layer
- Radial leads, cylindrical case, insulated with a blue sleeve
- Available in both vertical and low-profile versions
- Unlimited charge and discharge cycle numbers
- No charge-discharge control circuitry and no series resistor necessary
- Maintenance-free, no periodic replacement or service necessary
- Ecologically beneficial (no Cd, no Li)
- Material categorization: for definitions of compliance please see www.vishay.com/doc?99912


RoHS
COMPLIANT

APPLICATIONS

- Energy storage, for backup of semiconductor memories (CMOS) in all fields of electronics
- Telecommunication, audio-video, EDP
- General industrial, clock and timer systems

MARKING

The capacitors are marked with the following information:

- Rated capacitance (in F)
- Rated voltage (in V)
- Date code, in accordance with IEC 60062
- Name of manufacturer
- Negative terminal identification
- Upper category temperature (at 85 °C types only)

QUICK REFERENCE DATA				
DESCRIPTION	VALUE			
	STANDARD FORM A	HIGH VOLTAGE FORM A	HIGH TEMPERATURE FORM A	VERTICAL, MINIATURIZED FORM B
Nominal case sizes (Ø D x L in mm)	13 x 7 and 21 x 7.5	13 x 9 and 21 x 9	13 x 9 and 21 x 9	11.5 x 13 (vertical)
Rated capacitance range, C _R	0.047 F to 1.0 F	0.047 F to 0.68 F	0.047 F to 0.68 F	0.047 F to 0.33 F
Tolerance on C _R at 20 °C	-20 % to +80 %			
Rated voltage, U _R	5.5 V	6.3 V	5.5 V	5.5 V
Maximum surge voltage, U _S	6.3 V	7.0 V	6.3 V	6.3 V
Category temperature range	-25 °C to +70 °C	-25 °C to +70 °C	-25 °C to +85 °C	-25 °C to +70 °C
Useful life at U _R :				
at 85 °C	-	-	1000 h	-
at 70 °C	1000 h	1000 h	2800 h	1000 h
at 40 °C	8000 h	8000 h	23 000 h	8000 h
at 25 °C	23 000 h	23 000 h	64 000 h	23 000 h
Shelf life at 0 V	1000 h at upper category temperature			
Climatic category IEC 60068	25 / 070 / 21	25 / 070 / 21	25 / 085 / 21	25 / 070 / 21

SELECTION CHART FOR C_R, U_R, AND FORM AT UPPER CATEGORY TEMPERATURE (UCT)				
C_R (F)	FORM	$U_R = 5.5 V$		$U_R = 6.3 V$
		UCT = 85 °C	UCT = 70 °C	UCT = 70 °C
0.047	A	13 x 9	13 x 7	13 x 9
	B	-	11.5 x 13	-
0.1	A	13 x 9 x 9	13 x 7	13 x 9
	B	-	11.5 x 13	-
0.22	A	-	13 x 7	-
	B	-	11.5 x 13	-
0.33	A	-	13 x 7	-
	B	-	11.5 x 13	-
0.47	A	21 x 9	21 x 7.5	21 x 9
	B	-	-	-
0.68	A	21 x 9	-	21 x 9
	B	-	-	-
1.0	A	-	21 x 7.5	-

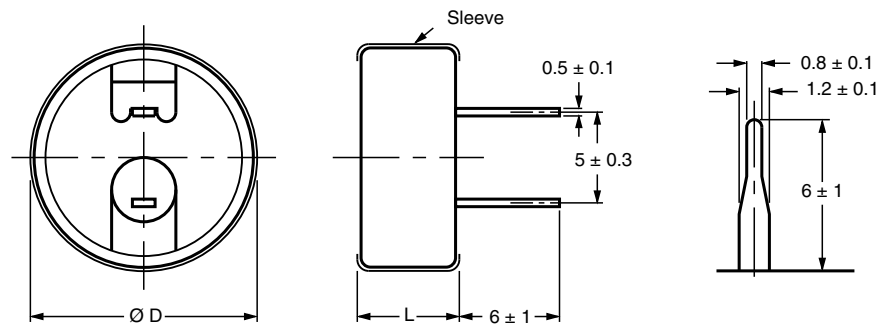
DIMENSIONS in millimeters **AND AVAILABLE FORMS**


Fig. 1 - Form A: Low profile

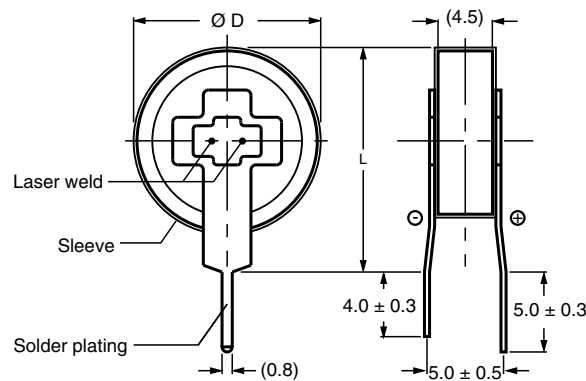


Fig. 2 - Form B: Vertical

DIMENSIONS in millimeters, MASS AND PACKAGING QUANTITIES						
NOMINAL CASE SIZE $\varnothing D \times L$ (mm)	CASE CODE	FORM	$\varnothing D_{max.}$	$L_{max.}$	MASS (g)	PACKAGING QUANTITIES
11.5 x 13	1	B	11.8	13.5	≈ 1.5	2000
13 x 7	2	A	13.5	7.5	≈ 2.8	1000
13 x 9	3	A	13.5	9.5	≈ 3.4	1000
21 x 7.5	4	A	21.5	8.0	≈ 7.1	500
21 x 9	5	A	21.5	9.5	≈ 8.8	500

Note

- Packaging: bulk in box.



ELECTRICAL DATA	
SYMBOL	DESCRIPTION
C_R	Rated capacitance, tolerance -20 % / +80 %, measured by constant current discharge method
UCT	Upper category temperature
I_L	Max. leakage current after 30 min at U_R
R_i	Max. internal resistance at 1 kHz

ORDERING EXAMPLE

Double layer capacitor 196 series

1.0 F / 5.5 V

Nominal case size: \varnothing 21 mm x 7.5 mm; Form A

Ordering code: MAL2 19612105E3

Former 12 NC: 2222 19612105

Note

- Unless otherwise specified, all electrical values in Table 1 apply at $T_{amb} = 20\text{ }^\circ\text{C}$, $P = 86\text{ kPa}$ to 106 kPa and $RH = 45\%$ to 75% .

Table 1

ELECTRICAL DATA AND ORDERING INFORMATION								
U_R (V)	C_R (F)	NOMINAL CASE SIZE $\varnothing D \times L$ (mm)	CASE CODE	FORM	UCT ($^\circ\text{C}$)	I_L 30 min (μA)	R_i 1 kHz (Ω)	ORDERING CODE
STANDARD SERIES								
5.5	0.047	13 x 7	2	A	70	69	120	MAL219612473E3
	0.10	13 x 7	2	A	70	100	75	MAL219612104E3
	0.22	13 x 7	2	A	70	135	75	MAL219612224E3
	0.33	13 x 7	2	A	70	182	75	MAL219612334E3
	0.47	21 x 7.5	4	A	70	216	30	MAL219612474E3
	1.0	21 x 7.5	4	A	70	315	30	MAL219612105E3
HIGH TEMPERATURE SERIES								
5.5	0.047	13 x 9	3	A	85	69	300	MAL219622473E3
	0.10	13 x 9	3	A	85	100	200	MAL219622104E3
	0.47	21 x 9	5	A	85	216	50	MAL219622474E3
	0.68	21 x 9	5	A	85	260	50	MAL219622684E3
VERTICAL, MINIATURIZED SERIES								
5.5	0.047	11.5 x 13	1	B	70	69	120	MAL219632473E3
	0.10	11.5 x 13	1	B	70	100	75	MAL219632104E3
	0.22	11.5 x 13	1	B	70	135	75	MAL219632224E3
	0.33	11.5 x 13	1	B	70	182	75	MAL219632334E3
HIGH VOLTAGE SERIES								
6.3	0.047	13 x 9	3	A	70	69	300	MAL219613473E3
	0.10	13 x 9	3	A	70	100	200	MAL219613104E3
	0.47	21 x 9	5	A	70	216	50	MAL219613474E3
	0.68	21 x 9	5	A	70	260	50	MAL219613684E3

MEASURING OF CHARACTERISTICS

CAPACITANCE (C)

Capacitance shall be measured by constant current discharge method.

DISCHARGE CURRENT AS A FUNCTION OF RATED CAPACITANCE								
PARAMETER	VALUE							UNIT
Rated capacitance, C _R	0.047	0.1	0.22	0.33	0.47	0.68	1.0	F
Discharge current, I _D	0.1			1.0				mA

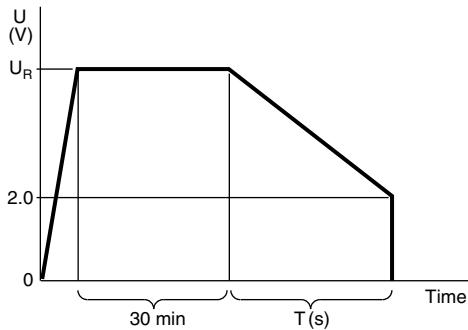


Fig. 3 - Voltage diagram for capacitance measurement

Capacitance value C_R is given by discharge current I_D, time T and rated voltage U_R, according to the following equation:

$$C(F) = \frac{I_D(mA) \times 10^{-3} \times T(s)}{U_R(V) - 2}$$

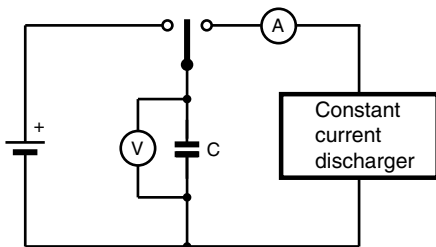


Fig. 4 - Test circuit for capacitance measurement

INTERNAL RESISTANCE (R_I) AT 1 kHz

$$R_I(\Omega) = \frac{V_C(V)}{10^{-3}}$$

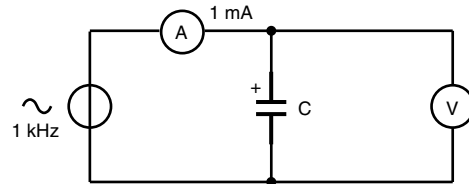


Fig. 5 - Test circuit for R_I measurement

LEAKAGE CURRENT (I_L)

Leakage current shall be measured after 30 min application of rated voltage U_R:

$$I_L(\mu A) = \frac{V(V)}{10^{-4}}$$

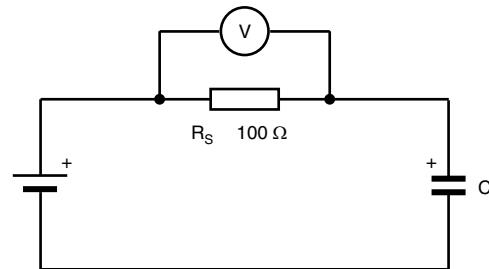


Fig. 6 - Test circuit for leakage current

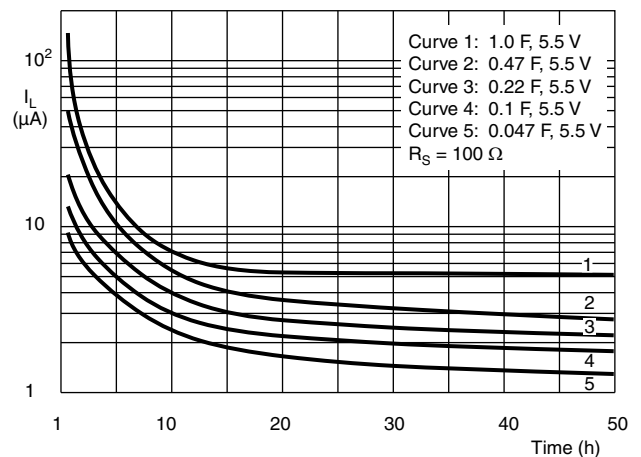


Fig. 7 - Typical leakage current as a function of time

DISCHARGE CHARACTERISTICS

Backup time of 196 DLC series capacitors depends on minimum memory holding voltage and discharge current (corresponding with the current consumption of the load). For minimum backup times of standard and vertical miniaturized series see Figures 8 and 9 (charging time ≥ 24 h).

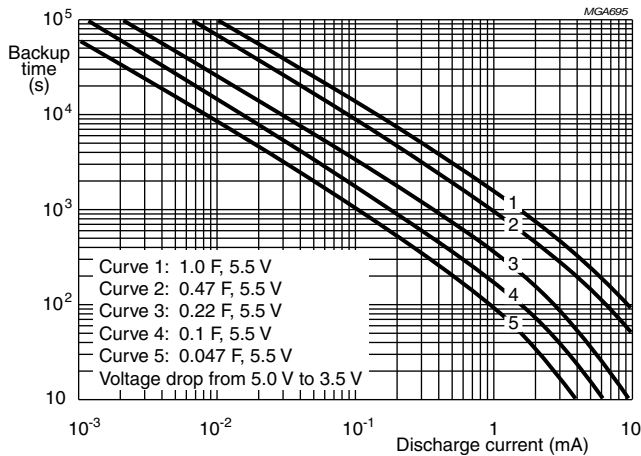


Fig. 8 - Typical backup time as a function of discharge current

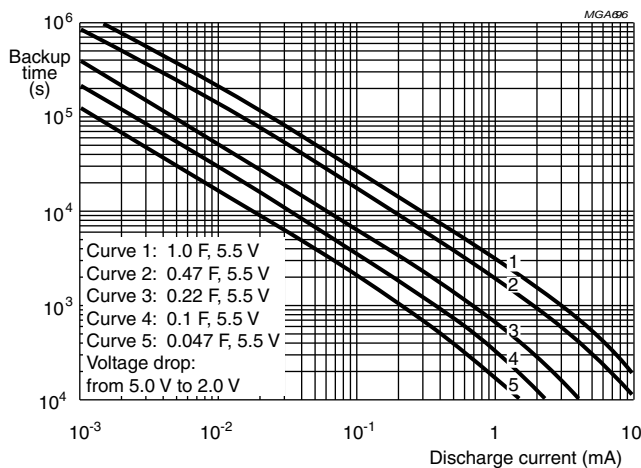


Fig. 9 - Typical backup time as a function of discharge current

Figure 10 shows the backup time when a 196 DLC capacitor is discharged by a constant resistance (charging time ≥ 24 h).

The horizontal axis shows the initial value of discharge current if 5 V is connected to the capacitor via a fixed series resistor.

Example: 1 μ A corresponds to 5 M Ω and 0.1 μ A corresponds to 50 M Ω

The vertical axis shows that period of time during which the voltage drops from 5 V to 2 V.

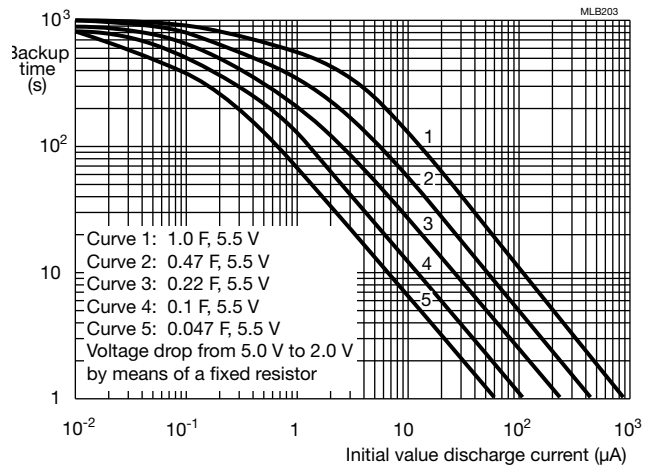


Fig. 10 - Typical backup time as a function of initial discharge current

Table 2

TEST PROCEDURES AND REQUIREMENTS for standard and vertical miniaturized series (5.5 V; 70 °C)			
NAME OF TEST	IEC 60384-4 / EN130300 SUBCLAUSE	PROCEDURE (quick reference)	REQUIREMENTS
Robustness of terminations	4.4	Tensile strength; application of loading force for 10 s: 20 N (standard series) 5 N (vertical miniaturized series)	No breaks
Resistance to soldering heat	4.5	Solder bath; 260 °C; 5 s	$\Delta C/C: \pm 10 \%$ R_I and $I_L \leq \text{spec. limit}$
Solderability	4.6	Solder bath; 235 °C; 2 s	$\geq 75 \%$ tinning
Vibration	4.8	10 Hz to 55 Hz; 1.5 mm; 3 directions; 2 h per direction	$\Delta C/C: \pm 10 \%$ R_I and $I_L \leq \text{spec. limit}$
Damp heat, steady state	4.12	500 h at 55 °C; RH 90 % to 95 %; no voltage applied	$\Delta C/C: \pm 30 \%$ $R_I \leq 4 \times \text{spec. limit}$ $I_L \leq 2 \times \text{spec. limit}$
Endurance	4.13	$T_{\text{amb}} = 70 \text{ °C}$; 5.5 V applied; 1000 h	$\Delta C/C: \pm 30 \%$ $R_I \leq 4 \times \text{spec. limit}$ $I_L \leq 2 \times \text{spec. limit}$
Useful life	-	$T_{\text{amb}} = 70 \text{ °C}$; 5.5 V applied; 1000 h	$\Delta C/C: \pm 30 \%$ $R_I \leq 4 \times \text{spec. limit}$ $I_L \leq 2 \times \text{spec. limit}$
Storage at upper category temperature	4.17	$T_{\text{amb}} = 70 \text{ °C}$; no voltage applied; 1000 h	$\Delta C/C: \pm 30 \%$ $R_I \leq 4 \times \text{spec. limit}$ $I_L \leq 2 \times \text{spec. limit}$
Self discharge	-	24 h storage at room temperature after application of 5 V for 1 h	Remaining voltage: $\geq 4 \text{ V}$
Characteristics at high and low temperature	4.19	Step 1: reference measurement at +20 °C of C, R_I and I_L Step 2: measurement at -25 °C Step 3: measurement at +20 °C Step 4: measurement at +70 °C Step 5: measurement at +20 °C	$\Delta C/C: \pm 30 \%$ of +20 °C value $R_I \leq 5 \times \text{the } +20 \text{ °C value}$ $I_L \leq 4 \times \text{the } +20 \text{ °C value}$

Statements about product lifetime are based on calculations and internal testing. They should only be interpreted as estimations. Also due to external factors, the lifetime in the field application may deviate from the calculated lifetime. In general, nothing stated herein shall be construed as a guarantee of durability.



Disclaimer

ALL PRODUCT, PRODUCT SPECIFICATIONS AND DATA ARE SUBJECT TO CHANGE WITHOUT NOTICE TO IMPROVE RELIABILITY, FUNCTION OR DESIGN OR OTHERWISE.

Vishay Intertechnology, Inc., its affiliates, agents, and employees, and all persons acting on its or their behalf (collectively, "Vishay"), disclaim any and all liability for any errors, inaccuracies or incompleteness contained in any datasheet or in any other disclosure relating to any product.

Vishay makes no warranty, representation or guarantee regarding the suitability of the products for any particular purpose or the continuing production of any product. To the maximum extent permitted by applicable law, Vishay disclaims (i) any and all liability arising out of the application or use of any product, (ii) any and all liability, including without limitation special, consequential or incidental damages, and (iii) any and all implied warranties, including warranties of fitness for particular purpose, non-infringement and merchantability.

Statements regarding the suitability of products for certain types of applications are based on Vishay's knowledge of typical requirements that are often placed on Vishay products in generic applications. Such statements are not binding statements about the suitability of products for a particular application. It is the customer's responsibility to validate that a particular product with the properties described in the product specification is suitable for use in a particular application. Parameters provided in datasheets and / or specifications may vary in different applications and performance may vary over time. All operating parameters, including typical parameters, must be validated for each customer application by the customer's technical experts. Product specifications do not expand or otherwise modify Vishay's terms and conditions of purchase, including but not limited to the warranty expressed therein.

Except as expressly indicated in writing, Vishay products are not designed for use in medical, life-saving, or life-sustaining applications or for any other application in which the failure of the Vishay product could result in personal injury or death. Customers using or selling Vishay products not expressly indicated for use in such applications do so at their own risk. Please contact authorized Vishay personnel to obtain written terms and conditions regarding products designed for such applications.

No license, express or implied, by estoppel or otherwise, to any intellectual property rights is granted by this document or by any conduct of Vishay. Product names and markings noted herein may be trademarks of their respective owners.

单击下面可查看定价，库存，交付和生命周期等信息

[>>Vishay\(威世\)](#)

[>>点击查看相关商品](#)