

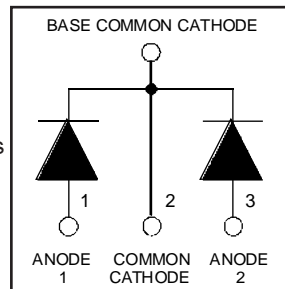
# HFA80NK40C

HEXFRED™

Ultrafast, Soft Recovery Diode

## Features

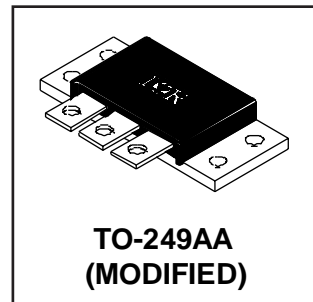
- Reduced RFI and EMI
- Reduced Snubbing
- Extensive Characterization of Recovery Parameters



$V_R = 400V$
$V_F(\text{typ.})^{\text{Ⓢ}} = 1V$
$I_{F(AV)} = 80A$
$Q_{rr}(\text{typ.}) = 200nC$
$I_{RRM}(\text{typ.}) = 6A$
$t_{rr}(\text{typ.}) = 30ns$
$di_{(rec)M}/dt(\text{typ.})^{\text{Ⓢ}} = 190A/\mu s$

## Description

HEXFRED™ diodes are optimized to reduce losses and EMI/RFI in high frequency power conditioning systems. An extensive characterization of the recovery behavior for different values of current, temperature and di/dt simplifies the calculations of losses in the operating conditions. The softness of the recovery eliminates the need for a snubber in most applications. These devices are ideally suited for power converters, motors drives and other applications where switching losses are significant portion of the total losses.



## Absolute Maximum Ratings (per Leg)

	Parameter	Max.	Units
$V_R$	Cathode-to-Anode Voltage	400	V
$I_F @ T_C = 25^\circ C$	Continuous Forward Current	89	A
$I_F @ T_C = 100^\circ C$	Continuous Forward Current	44	
$I_{FSM}$	Single Pulse Forward Current ①	300	mJ
$I_{AS}$	Maximum Single Pulse Avalanche Current ②	5.0	
$E_{AS}$	Non-Repetitive Avalanche Energy ③	1.4	W
$P_D @ T_C = 25^\circ C$	Maximum Power Dissipation	160	
$P_D @ T_C = 100^\circ C$	Maximum Power Dissipation	63	
$T_J$	Operating Junction and	-55 to +150	°C
$T_{STG}$	Storage Temperature Range		
	Soldering Temperature, for 10 sec.	300 (0.063 in. (1.6mm) from case)	

## Thermal - Mechanical Characteristics

	Parameter	Min.	Typ.	Max.	Units
$R_{\theta JC}$	Junction-to-Case, Single Leg Conducting	----	----	0.80	°C/W
	Junction-to-Case, Both Legs Conducting	----	----	0.40	
$R_{\theta CS}$	Case-to-Sink, Flat , Greased Surface	----	0.10	----	K/W
$Wt$	Weight	----	58 (2.0)	----	g (oz)
	Mounting Torque	35 (4.0)	----	50 (5.7)	lbf•in (N•m)

**Note:** ① Limited by junction temperature  
 ② L = 100μH, duty cycle limited by max  $T_J$   
 ③ 125°C

# HFA80NK40C

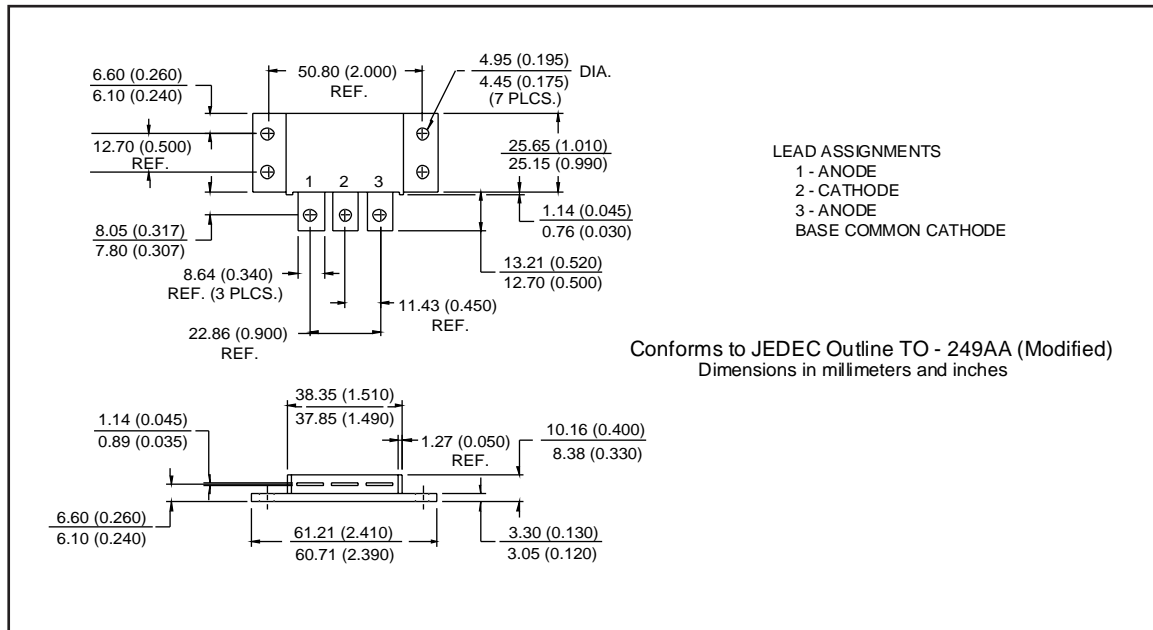
International  
IOR Rectifier

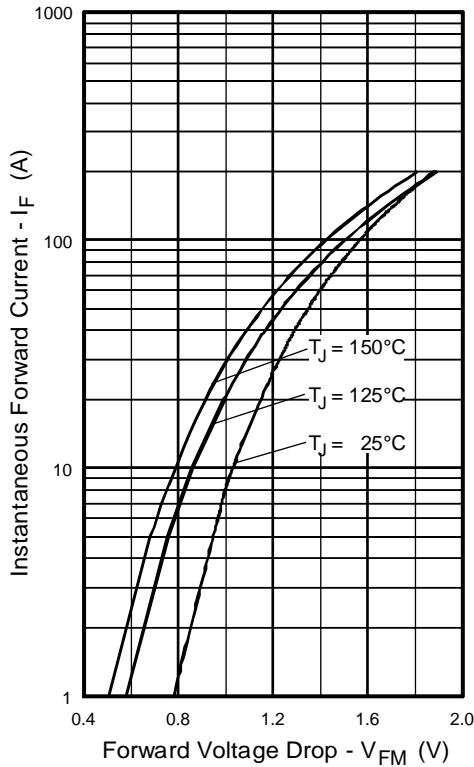
## Electrical Characteristics (per Leg) @ T<sub>J</sub> = 25°C (unless otherwise specified)

	Parameter	Min.	Typ.	Max.	Units	Test Conditions	
V <sub>BR</sub>	Cathode Anode Breakdown Voltage	400	—	—	V	I <sub>R</sub> = 100μA	
V <sub>FM</sub>	Max Forward Voltage	—	1.1	1.3	V	I <sub>F</sub> = 40A	
		—	1.3	1.5		I <sub>F</sub> = 80A	See Fig. 1
		—	1.0	1.2	μA	I <sub>F</sub> = 40A, T <sub>J</sub> = 125°C	
I <sub>RM</sub>	Max Reverse Leakage Current	—	0.50	3.0	μA	V <sub>R</sub> = V <sub>R</sub> Rated	
		—	0.75	4.0	mA	T <sub>J</sub> = 125°C, V <sub>R</sub> = 320V	See Fig. 2
C <sub>T</sub>	Junction Capacitance	—	90	125	pF	V <sub>R</sub> = 200V	See Fig. 3
L <sub>S</sub>	Series Inductance	—	8.0	—	nH	From terminal hole to terminal hole	

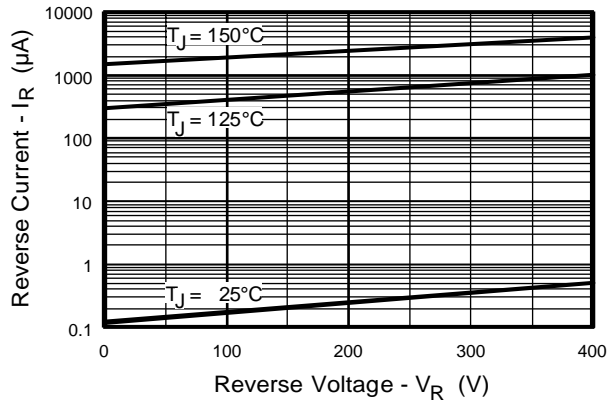
## Dynamic Recovery Characteristics (per Leg) @ T<sub>J</sub> = 25°C (unless otherwise specified)

	Parameter	Min.	Typ.	Max.	Units	Test Conditions	
t <sub>rr</sub>	Reverse Recovery Time	—	30	—	ns	I <sub>F</sub> = 1.0A, di <sub>F</sub> /dt = 200A/μs, V <sub>R</sub> = 30V	
t <sub>rr1</sub>		—	67	100		T <sub>J</sub> = 25°C	See Fig.
t <sub>rr2</sub>		—	110	170		T <sub>J</sub> = 125°C	5
I <sub>RRM1</sub>	Peak Recovery Current	—	6.0	11	A	T <sub>J</sub> = 25°C	See Fig.
I <sub>RRM2</sub>		—	9.0	16		T <sub>J</sub> = 125°C	
Q <sub>rr1</sub>	Reverse Recovery Charge	—	200	540	nC	T <sub>J</sub> = 25°C	See Fig.
Q <sub>rr2</sub>		—	500	1300		T <sub>J</sub> = 125°C	
di <sub>(rec)M</sub> /dt1	Peak Rate of Fall of Recovery Current During t <sub>b</sub>	—	240	—	A/μs	T <sub>J</sub> = 25°C	See Fig.
di <sub>(rec)M</sub> /dt2		—	190	—		T <sub>J</sub> = 125°C	

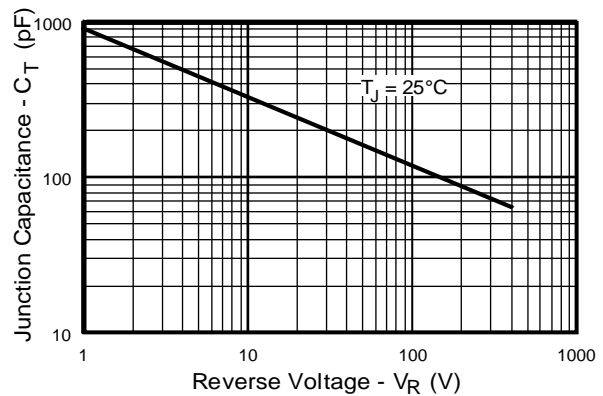




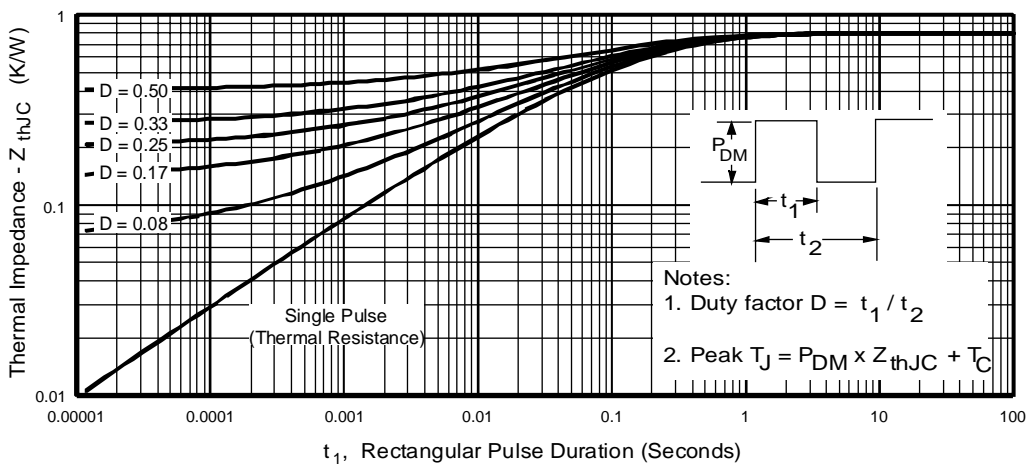
**Fig. 1 - Maximum Forward Voltage Drop vs. Instantaneous Forward Current, (per Leg)**



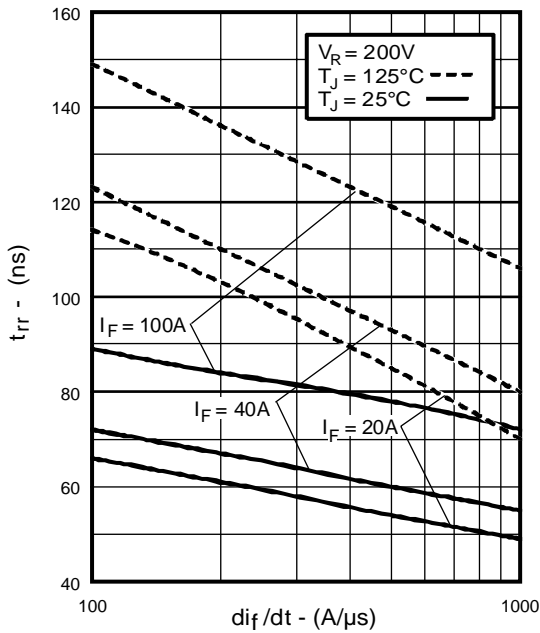
**Fig. 2 - Typical Reverse Current vs. Reverse Voltage, (per Leg)**



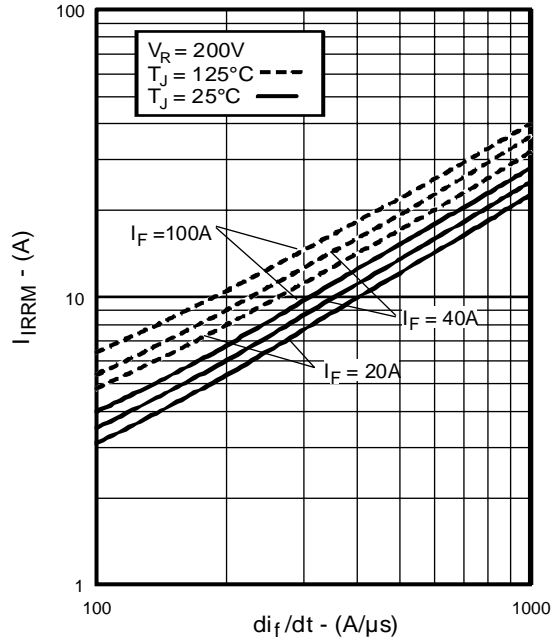
**Fig. 3 - Typical Junction Capacitance vs. Reverse Voltage, (per Leg)**



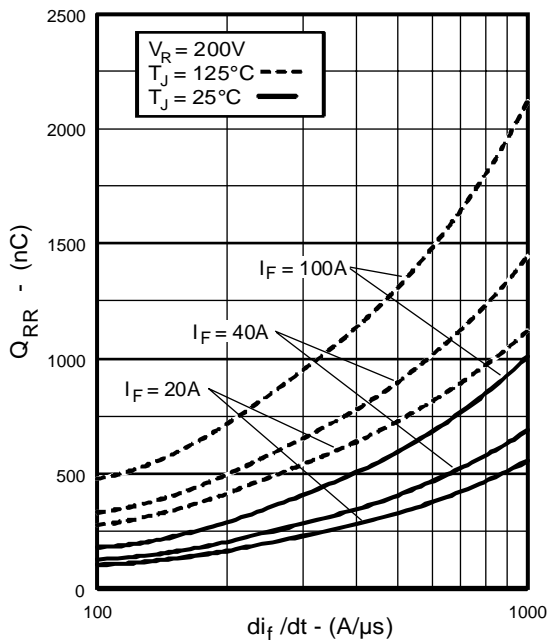
**Fig. 4 - Maximum Thermal Impedance  $Z_{thJC}$  Characteristics, (per Leg)**



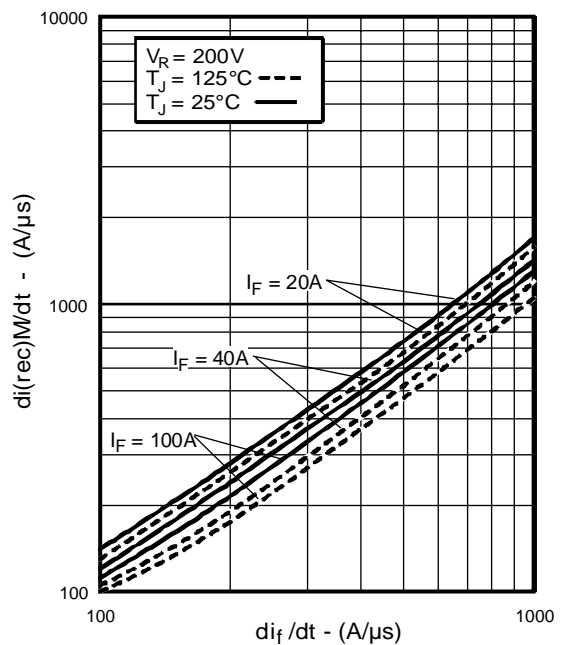
**Fig. 5 - Typical Reverse Recovery vs.  $di_f/dt$ , (per Leg)**



**Fig. 6 - Typical Recovery Current vs.  $di_f/dt$ , (per Leg)**



**Fig. 7 - Typical Stored Charge vs.  $di_f/dt$ , (per Leg)**



**Fig. 8 - Typical  $di_{(rec)M}/dt$  vs.  $di_f/dt$ , (per Leg)**

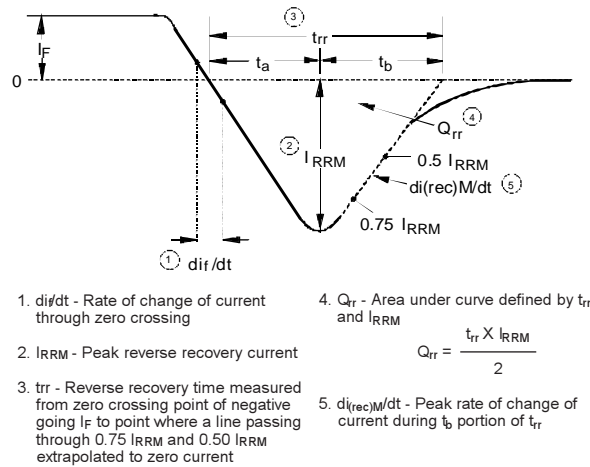
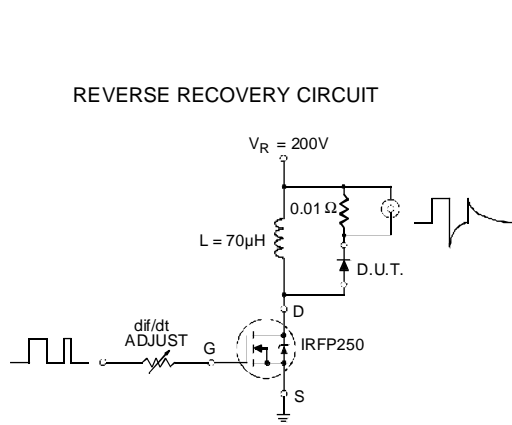


Fig. 9 - Reverse Recovery Parameter Test Circuit

Fig. 10 - Reverse Recovery Waveform and Definitions

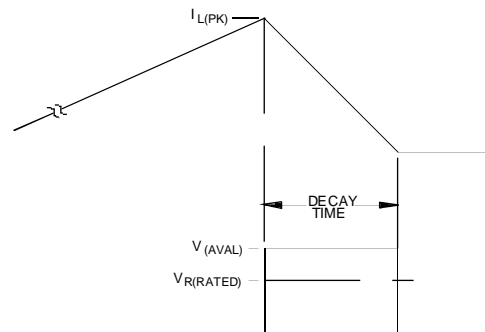
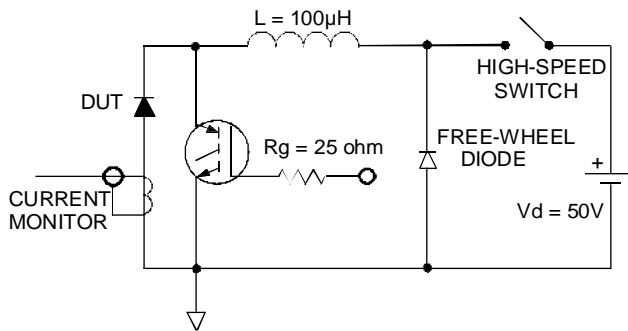


Fig. 11 - Avalanche Test Circuit and Waveforms

单击下面可查看定价，库存，交付和生命周期等信息

[>>Vishay\(威世\)](#)