

Two-Line ESD Protection Diode in SOT-23

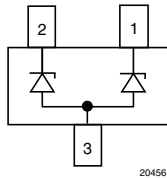

20456

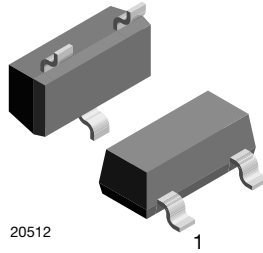

20512

1

MARKING (example only)

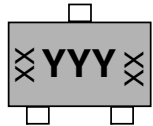

20357

YYY = type code (see table below)
XX = date code

LINKS TO ADDITIONAL RESOURCES



3D Models



Models

FEATURES

- Two-line unidirectional ESD protection diode
- Common anode
- Can be used as bidirectional protection diode
- ESD immunity acc. IEC 61000-4-2 and ISO 10605
± 30 kV contact discharge
± 30 kV air discharge
- ESD capability according to AEC-Q101:
human body model: class H3B: > 8 kV
- e3 - Sn
- AEC-Q101 qualified available
- Material categorization: for definitions of compliance please see www.vishay.com/doc?99912



PRIMARY CHARACTERISTICS	
V _{BR}	4 V to 47 V
V _{RWM}	3.3 V to 36 V
P _{PPM} (8/20µs)	400 W to 540 W
P _{PPM} (10 x 1000µs)	44 W
ESD immunity (330 pF / 330 Ω)	± 30 kV
T _J max.	150 °C
Polarity	Unidirectional
Package	SOT-23
Circuit configuration	Dual, common anode

ORDERING INFORMATION							
PART NUMBER (EXAMPLE)	ENVIRONMENTAL AND QUALITY CODE			REVISION	PACKAGING CODE		ORDERING CODE (EXAMPLE)
	AEC-Q101 QUALIFIED	RoHS-COMPLIANT + LEAD (Pb)-FREE TERMINATIONS	TIN PLATED		3K PER 7" REEL (8 mm TAPE), 15K/BOX = MOQ	10K PER 13" REEL (8 mm TAPE), 10K/BOX = MOQ	
VGSOT05C-		G	3	-	08		VGSOT05C-G3-08
VGSOT05C-	H	G	3	-	08		VGSOT05C-HG3-08
VGSOT05C-		G	3	-		18	VGSOT05C-G3-18
VGSOT05C-	H	G	3	-		18	VGSOT05C-HG3-18



PACKAGE DATA							
DEVICE NAME	PACKAGE NAME	TYPE CODE	ENVIRONMENTAL STATUS	WEIGHT	MOLDING COMPOUND FLAMMABILITY RATING	MOISTURE SENSITIVITY LEVEL	SOLDERING CONDITIONS
VGSOT03C	SOT-23	H03	Green	9.2 mg	UL 94 V-0	MSL level 1 (according J-STD-020)	Peak temperature max. 260 °C
VGSOT04C	SOT-23	H04	Green	9.2 mg	UL 94 V-0	MSL level 1 (according J-STD-020)	Peak temperature max. 260 °C
VGSOT05C	SOT-23	H05	Green	9.2 mg	UL 94 V-0	MSL level 1 (according J-STD-020)	Peak temperature max. 260 °C
VGSOT08C	SOT-23	H08	Green	9.2 mg	UL 94 V-0	MSL level 1 (according J-STD-020)	Peak temperature max. 260 °C
VGSOT12C	SOT-23	H12	Green	9.2 mg	UL 94 V-0	MSL level 1 (according J-STD-020)	Peak temperature max. 260 °C
VGSOT15C	SOT-23	H15	Green	9.2 mg	UL 94 V-0	MSL level 1 (according J-STD-020)	Peak temperature max. 260 °C
VGSOT22C	SOT-23	H22	Green	9.2 mg	UL 94 V-0	MSL level 1 (according J-STD-020)	Peak temperature max. 260 °C
VGSOT24C	SOT-23	H24	Green	9.2 mg	UL 94 V-0	MSL level 1 (according J-STD-020)	Peak temperature max. 260 °C
VGSOT36C	SOT-23	H36	Green	9.2 mg	UL 94 V-0	MSL level 1 (according J-STD-020)	Peak temperature max. 260 °C

ABSOLUTE MAXIMUM RATINGS VGSOT03C ($T_{amb} = 25\text{ °C}$ unless otherwise specified)				
PARAMETER	TEST CONDITIONS	SYMBOL	VALUE	UNIT
Peak pulse current	$t_p = 8/20\ \mu\text{s}$ acc. IEC 61000-4-5; single shot	I_{PPM}	44	A
	$t_p = 10/1000\ \mu\text{s}$; single shot		6	A
Peak pulse power	$t_p = 8/20\ \mu\text{s}$ acc. IEC 61000-4-5; single shot	P_{PP}	540	W
	$t_p = 10/1000\ \mu\text{s}$; single shot		44	W
ESD immunity	Air and contact discharge acc. ISO 10605 (330 pF / 330 Ω); 10 pulses	V_{ESD}	± 30	kV
	Air and contact discharge acc. IEC 61000-4-2 (150 pF / 330 Ω); 10 pulses		± 30	kV
Operating temperature	Junction temperature	T_J	-55 to +150	°C
Storage temperature		T_{STG}	-55 to +150	°C

ABSOLUTE MAXIMUM RATINGS VGSOT04C ($T_{amb} = 25\text{ °C}$ unless otherwise specified)				
PARAMETER	TEST CONDITIONS	SYMBOL	VALUE	UNIT
Peak pulse current	$t_p = 8/20\ \mu\text{s}$ acc. IEC 61000-4-5; single shot	I_{PPM}	40	A
	$t_p = 10/1000\ \mu\text{s}$; single shot		5	A
Peak pulse power	$t_p = 8/20\ \mu\text{s}$ acc. IEC 61000-4-5; single shot	P_{PP}	540	W
	$t_p = 10/1000\ \mu\text{s}$; single shot		44	W
ESD immunity	Air and contact discharge acc. ISO 10605 (330 pF / 330 Ω); 10 pulses	V_{ESD}	± 30	kV
	Air and contact discharge acc. IEC 61000-4-2 (150 pF / 330 Ω); 10 pulses		± 30	kV
Operating temperature	Junction temperature	T_J	-55 to +150	°C
Storage temperature		T_{STG}	-55 to +150	°C



ABSOLUTE MAXIMUM RATINGS VGSOT05C ($T_{amb} = 25\text{ }^{\circ}\text{C}$ unless otherwise specified)				
PARAMETER	TEST CONDITIONS	SYMBOL	VALUE	UNIT
Peak pulse current	$t_p = 8/20\text{ }\mu\text{s}$ acc. IEC 61000-4-5; single shot	I_{PPM}	36	A
	$t_p = 10/1000\text{ }\mu\text{s}$; single shot		4	A
Peak pulse power	$t_p = 8/20\text{ }\mu\text{s}$ acc. IEC 61000-4-5; single shot	P_{PP}	500	W
	$t_p = 10/1000\text{ }\mu\text{s}$; single shot		44	W
ESD immunity	Air and contact discharge acc. ISO 10605 (330 pF / 330 Ω); 10 pulses	V_{ESD}	± 30	kV
	Air and contact discharge acc. IEC 61000-4-2 (150 pF / 330 Ω); 10 pulses		± 30	kV
Operating temperature	Junction temperature	T_J	-55 to +150	$^{\circ}\text{C}$
Storage temperature		T_{STG}	-55 to +150	$^{\circ}\text{C}$

ABSOLUTE MAXIMUM RATINGS VGSOT08C ($T_{amb} = 25\text{ }^{\circ}\text{C}$ unless otherwise specified)				
PARAMETER	TEST CONDITIONS	SYMBOL	VALUE	UNIT
Peak pulse current	$t_p = 8/20\text{ }\mu\text{s}$ acc. IEC 61000-4-5; single shot	I_{PPM}	28	A
	$t_p = 10/1000\text{ }\mu\text{s}$; single shot		3	A
Peak pulse power	$t_p = 8/20\text{ }\mu\text{s}$ acc. IEC 61000-4-5; single shot	P_{PP}	500	W
	$t_p = 10/1000\text{ }\mu\text{s}$; single shot		44	W
ESD immunity	Air and contact discharge acc. ISO 10605 (330 pF / 330 Ω); 10 pulses	V_{ESD}	± 30	kV
	Air and contact discharge acc. IEC 61000-4-2 (150 pF / 330 Ω); 10 pulses		± 30	kV
Operating temperature	Junction temperature	T_J	-55 to +150	$^{\circ}\text{C}$
Storage temperature		T_{STG}	-55 to +150	$^{\circ}\text{C}$

ABSOLUTE MAXIMUM RATINGS VGSOT12C ($T_{amb} = 25\text{ }^{\circ}\text{C}$ unless otherwise specified)				
PARAMETER	TEST CONDITIONS	SYMBOL	VALUE	UNIT
Peak pulse current	$t_p = 8/20\text{ }\mu\text{s}$ acc. IEC 61000-4-5; single shot	I_{PPM}	18.5	A
	$t_p = 10/1000\text{ }\mu\text{s}$; single shot		2	A
Peak pulse power	$t_p = 8/20\text{ }\mu\text{s}$ acc. IEC 61000-4-5; single shot	P_{PP}	480	W
	$t_p = 10/1000\text{ }\mu\text{s}$; single shot		44	W
ESD immunity	Air and contact discharge acc. ISO 10605 (330 pF / 330 Ω); 10 pulses	V_{ESD}	± 30	kV
	Air and contact discharge acc. IEC 61000-4-2 (150 pF / 330 Ω); 10 pulses		± 30	kV
Operating temperature	Junction temperature	T_J	-55 to +150	$^{\circ}\text{C}$
Storage temperature		T_{STG}	-55 to +150	$^{\circ}\text{C}$

ABSOLUTE MAXIMUM RATINGS VGSOT15C ($T_{amb} = 25\text{ }^{\circ}\text{C}$ unless otherwise specified)				
PARAMETER	TEST CONDITIONS	SYMBOL	VALUE	UNIT
Peak pulse current	$t_p = 8/20\text{ }\mu\text{s}$ acc. IEC 61000-4-5; single shot	I_{PPM}	15.5	A
	$t_p = 10/1000\text{ }\mu\text{s}$; single shot		1.6	A
Peak pulse power	$t_p = 8/20\text{ }\mu\text{s}$ acc. IEC 61000-4-5; single shot	P_{PP}	450	W
	$t_p = 10/1000\text{ }\mu\text{s}$; single shot		44	W
ESD immunity	Air and contact discharge acc. ISO 10605 (330 pF / 330 Ω); 10 pulses	V_{ESD}	± 30	kV
	Air and contact discharge acc. IEC 61000-4-2 (150 pF / 330 Ω); 10 pulses		± 30	kV
Operating temperature	Junction temperature	T_J	-55 to +150	$^{\circ}\text{C}$
Storage temperature		T_{STG}	-55 to +150	$^{\circ}\text{C}$



ABSOLUTE MAXIMUM RATINGS VGSOT22C ($T_{amb} = 25\text{ }^{\circ}\text{C}$ unless otherwise specified)				
PARAMETER	TEST CONDITIONS	SYMBOL	VALUE	UNIT
Peak pulse current	$t_p = 8/20\text{ }\mu\text{s}$ acc. IEC 61000-4-5; single shot	I_{PPM}	9.4	A
	$t_p = 10/1000\text{ }\mu\text{s}$; single shot		1.1	A
Peak pulse power	$t_p = 8/20\text{ }\mu\text{s}$ acc. IEC 61000-4-5; single shot	P_{PP}	400	W
	$t_p = 10/1000\text{ }\mu\text{s}$; single shot		44	W
ESD immunity	Air and contact discharge acc. ISO 10605 (330 pF / 330 Ω); 10 pulses	V_{ESD}	± 30	kV
	Air and contact discharge acc. IEC 61000-4-2 (150 pF / 330 Ω); 10 pulses		± 30	kV
Operating temperature	Junction temperature	T_J	-55 to +150	$^{\circ}\text{C}$
Storage temperature		T_{STG}	-55 to +150	$^{\circ}\text{C}$

ABSOLUTE MAXIMUM RATINGS VGSOT24C ($T_{amb} = 25\text{ }^{\circ}\text{C}$ unless otherwise specified)				
PARAMETER	TEST CONDITIONS	SYMBOL	VALUE	UNIT
Peak pulse current	$t_p = 8/20\text{ }\mu\text{s}$ acc. IEC 61000-4-5; single shot	I_{PPM}	8.4	A
	$t_p = 10/1000\text{ }\mu\text{s}$; single shot		1	A
Peak pulse power	$t_p = 8/20\text{ }\mu\text{s}$ acc. IEC 61000-4-5; single shot	P_{PP}	400	W
	$t_p = 10/1000\text{ }\mu\text{s}$; single shot		44	W
ESD immunity	Air and contact discharge acc. ISO 10605 (330 pF / 330 Ω); 10 pulses	V_{ESD}	± 30	kV
	Air and contact discharge acc. IEC 61000-4-2 (150 pF / 330 Ω); 10 pulses		± 30	kV
Operating temperature	Junction temperature	T_J	-55 to +150	$^{\circ}\text{C}$
Storage temperature		T_{STG}	-55 to +150	$^{\circ}\text{C}$

ABSOLUTE MAXIMUM RATINGS VGSOT36C ($T_{amb} = 25\text{ }^{\circ}\text{C}$ unless otherwise specified)				
PARAMETER	TEST CONDITIONS	SYMBOL	VALUE	UNIT
Peak pulse current	$t_p = 8/20\text{ }\mu\text{s}$ acc. IEC 61000-4-5; single shot	I_{PPM}	5.6	A
	$t_p = 10/1000\text{ }\mu\text{s}$; single shot		0.7	A
Peak pulse power	$t_p = 8/20\text{ }\mu\text{s}$ acc. IEC 61000-4-5; single shot	P_{PP}	400	W
	$t_p = 10/1000\text{ }\mu\text{s}$; single shot		44	W
ESD immunity	Air and contact discharge acc. ISO 10605 (330 pF / 330 Ω); 10 pulses	V_{ESD}	± 30	kV
	Air and contact discharge acc. IEC 61000-4-2 (150 pF / 330 Ω); 10 pulses		± 30	kV
Operating temperature	Junction temperature	T_J	-55 to +150	$^{\circ}\text{C}$
Storage temperature		T_{STG}	-55 to +150	$^{\circ}\text{C}$

BiAs-MODE (2-line Bidirectional Asymmetrical protection mode)

With the VGSOTxxC two signal- or data-lines (L1, L2) can be protected against voltage transients. With pin 3 connected to ground and pin 1 and pin 2 connected to a signal- or data-line which has to be protected. As long as the voltage level on the data- or signal-line is between 0 V (ground level) and the specified Maximum Reverse Working Voltage (V_{RWM}) the protection diode between pin 2 and pin 3 and between pin 1 and pin 3 offers a high isolation to the ground line. The protection device behaves like an open switch.

As soon as any positive transient voltage signal exceeds the breakdown voltage level of the protection diode, the diode becomes conductive and shorts the transient current to ground. Now the protection device behaves like a closed switch. The Clamping Voltage (V_C) is defined by the breakdown voltage (V_{BR}) level plus the voltage drop at the series impedance (resistance and inductance) of the protection diode.

Any negative transient signal will be clamped accordingly. The negative transient current is flowing in the forward direction through the protection diode. The low Forward Voltage (V_F) clamps the negative transient close to the ground level.

Due to the different clamping levels in forward and reverse direction the VGSOTxxC clamping behavior is Bidirectional and Asymmetrical (BiAs).

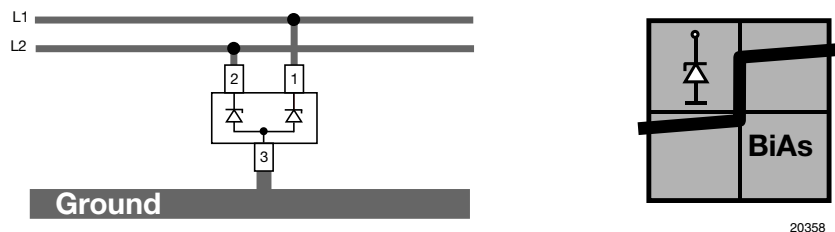

20358

If a higher surge current or peak pulse current (I_{PP}) is needed, both protection diodes in the VGSOTxxC can also be used in parallel in order to “double” the performance.

This offers:

- double surge power = double peak pulse current ($2 \times I_{PPM}$)
- half of the line inductance = reduced clamping voltage
- half of the line resistance = reduced clamping voltage
- double line capacitance ($2 \times C_D$)
- double reverse leakage current ($2 \times I_R$)

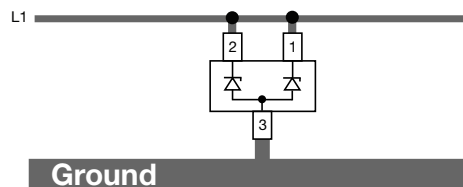

20359

ELECTRICAL CHARACTERISTICS VGSOT03C ($T_{amb} = 25\text{ }^\circ\text{C}$ unless otherwise specified)						
PARAMETER	TEST CONDITIONS / REMARKS	SYMBOL	MIN.	TYP.	MAX.	UNIT
Protection paths	Number of lines which can be protected	$N_{channel}$	-	-	2	lines
Reverse stand-off voltage	Max. reverse working voltage	V_{RWM}	-	-	3.3	V
Reverse voltage	At $I_R = 100\text{ }\mu\text{A}$	V_R	3.3	-	-	V
Reverse current	At $V_R = 3.3\text{ V}$	I_R	-	-	100	μA
Reverse breakdown voltage	At $I_R = 1\text{ mA}$	V_{BR}	4.0	4.6	5.5	V
Reverse clamping voltage	At $I_{PP} = 1\text{ A}$; $t_p = 8/20\text{ }\mu\text{s}$	V_C	-	5.7	7.5	V
	At $I_{PP} = I_{PPM} = 44\text{ A}$; $t_p = 8/20\text{ }\mu\text{s}$		-	9.2	12.3	V
Forward clamping voltage	At $I_{PP} = 1\text{ A}$; $t_p = 8/20\text{ }\mu\text{s}$	V_F	-	1	1.2	V
	At $I_{PP} = I_{PPM} = 44\text{ A}$; $t_p = 8/20\text{ }\mu\text{s}$		-	4.5	-	V
Capacitance	At $V_R = 0\text{ V}$; $f = 1\text{ MHz}$	C_D	-	460	600	pF
	At $V_R = 1.6\text{ V}$; $f = 1\text{ MHz}$		-	320	-	pF



ELECTRICAL CHARACTERISTICS VGSOT04C ($T_{amb} = 25\text{ }^{\circ}\text{C}$ unless otherwise specified)						
PARAMETER	TEST CONDITIONS / REMARKS	SYMBOL	MIN.	TYP.	MAX.	UNIT
Protection paths	Number of lines which can be protected	$N_{channel}$	-	-	2	lines
Reverse stand-off voltage	Max. reverse working voltage	V_{RWM}	-	-	4	V
Reverse voltage	At $I_R = 20\text{ }\mu\text{A}$	V_R	4	-	-	V
Reverse current	At $V_R = 4\text{ V}$	I_R	-	-	20	μA
Reverse breakdown voltage	At $I_R = 1\text{ mA}$	V_{BR}	5	6.1	7	V
Reverse clamping voltage	At $I_{PP} = 1\text{ A}$; $t_p = 8/20\text{ }\mu\text{s}$	V_C	-	6.5	8	V
	At $I_{PP} = I_{PPM} = 40\text{ A}$; $t_p = 8/20\text{ }\mu\text{s}$		-	10.3	13.5	V
Forward clamping voltage	At $I_{PP} = 1\text{ A}$; $t_p = 8/20\text{ }\mu\text{s}$	V_F	-	1	1.2	V
	At $I_{PP} = I_{PPM} = 40\text{ A}$; $t_p = 8/20\text{ }\mu\text{s}$		-	4.2	-	V
Capacitance	At $V_R = 0\text{ V}$; $f = 1\text{ MHz}$	C_D	-	360	450	pF
	At $V_R = 2\text{ V}$; $f = 1\text{ MHz}$		-	225	-	pF

ELECTRICAL CHARACTERISTICS VGSOT05C ($T_{amb} = 25\text{ }^{\circ}\text{C}$ unless otherwise specified)						
PARAMETER	TEST CONDITIONS / REMARKS	SYMBOL	MIN.	TYP.	MAX.	UNIT
Protection paths	Number of lines which can be protected	$N_{channel}$	-	-	2	lines
Reverse stand-off voltage	Max. reverse working voltage	V_{RWM}	-	-	5	V
Reverse voltage	At $I_R = 10\text{ }\mu\text{A}$	V_R	5	-	-	V
Reverse current	At $V_R = 5\text{ V}$	I_R	-	-	10	μA
Reverse breakdown voltage	At $I_R = 1\text{ mA}$	V_{BR}	6	6.8	8	V
Reverse clamping voltage	At $I_{PP} = 1\text{ A}$; $t_p = 8/20\text{ }\mu\text{s}$	V_C	-	7.3	8.7	V
	At $I_{PP} = I_{PPM} = 36\text{ A}$; $t_p = 8/20\text{ }\mu\text{s}$		-	11	14	V
Forward clamping voltage	At $I_{PP} = 1\text{ A}$; $t_p = 8/20\text{ }\mu\text{s}$	V_F	-	1	1.2	V
	At $I_{PP} = I_{PPM} = 36\text{ A}$; $t_p = 8/20\text{ }\mu\text{s}$		-	3.9	-	V
Capacitance	At $V_R = 0\text{ V}$; $f = 1\text{ MHz}$	C_D	-	276	350	pF
	At $V_R = 2.5\text{ V}$; $f = 1\text{ MHz}$		-	165	-	pF

ELECTRICAL CHARACTERISTICS VGSOT08C ($T_{amb} = 25\text{ }^{\circ}\text{C}$ unless otherwise specified)						
PARAMETER	TEST CONDITIONS / REMARKS	SYMBOL	MIN.	TYP.	MAX.	UNIT
Protection paths	Number of lines which can be protected	$N_{channel}$	-	-	2	lines
Reverse stand-off voltage	Max. reverse working voltage	V_{RWM}	-	-	8	V
Reverse voltage	At $I_R = 5\text{ }\mu\text{A}$	V_R	8	-	-	V
Reverse current	At $V_R = 8\text{ V}$	I_R	-	-	5	μA
Reverse breakdown voltage	At $I_R = 1\text{ mA}$	V_{BR}	9	10	11	V
Reverse clamping voltage	At $I_{PP} = 1\text{ A}$; $t_p = 8/20\text{ }\mu\text{s}$	V_C	-	10.7	13	V
	At $I_{PP} = I_{PPM} = 28\text{ A}$; $t_p = 8/20\text{ }\mu\text{s}$		-	14.4	18	V
Forward clamping voltage	At $I_{PP} = 1\text{ A}$; $t_p = 8/20\text{ }\mu\text{s}$	V_F	-	1	1.2	V
	At $I_{PP} = I_{PPM} = 28\text{ A}$; $t_p = 8/20\text{ }\mu\text{s}$		-	3.2	-	V
Capacitance	At $V_R = 0\text{ V}$; $f = 1\text{ MHz}$	C_D	-	175	250	pF
	At $V_R = 4\text{ V}$; $f = 1\text{ MHz}$		-	90	-	pF



ELECTRICAL CHARACTERISTICS VGSOT12C ($T_{amb} = 25\text{ }^{\circ}\text{C}$ unless otherwise specified)						
PARAMETER	TEST CONDITIONS / REMARKS	SYMBOL	MIN.	TYP.	MAX.	UNIT
Protection paths	Number of lines which can be protected	$N_{channel}$	-	-	2	lines
Reverse stand-off voltage	Max. reverse working voltage	V_{RWM}	-	-	12	V
Reverse voltage	At $I_R = 1\text{ }\mu\text{A}$	V_R	12	-	-	V
Reverse current	At $V_R = 12\text{ V}$	I_R	-	-	1	μA
Reverse breakdown voltage	At $I_R = 1\text{ mA}$	V_{BR}	13.5	15	16.5	V
Reverse clamping voltage	At $I_{PP} = 1\text{ A}$; $t_p = 8/20\text{ }\mu\text{s}$	V_C	-	15.4	18.7	V
	At $I_{PP} = I_{PPM} = 18.5\text{ A}$; $t_p = 8/20\text{ }\mu\text{s}$		-	20.2	26	V
Forward clamping voltage	At $I_{PP} = 1\text{ A}$; $t_p = 8/20\text{ }\mu\text{s}$	V_F	-	1	1.2	V
	At $I_{PP} = I_{PPM} = 18.5\text{ A}$; $t_p = 8/20\text{ }\mu\text{s}$		-	2.5	-	V
Capacitance	At $V_R = 0\text{ V}$; $f = 1\text{ MHz}$	C_D	-	115	150	pF
	At $V_R = 6\text{ V}$; $f = 1\text{ MHz}$		-	54	-	pF

ELECTRICAL CHARACTERISTICS VGSOT15C ($T_{amb} = 25\text{ }^{\circ}\text{C}$ unless otherwise specified)						
PARAMETER	TEST CONDITIONS / REMARKS	SYMBOL	MIN.	TYP.	MAX.	UNIT
Protection paths	Number of lines which can be protected	$N_{channel}$	-	-	2	lines
Reverse stand-off voltage	Max. reverse working voltage	V_{RWM}	-	-	15	V
Reverse voltage	At $I_R = 1\text{ }\mu\text{A}$	V_R	15	-	-	V
Reverse current	At $V_R = 15\text{ V}$	I_R	-	-	1	μA
Reverse breakdown voltage	At $I_R = 1\text{ mA}$	V_{BR}	16.5	18	20	V
Reverse clamping voltage	At $I_{PP} = 1\text{ A}$; $t_p = 8/20\text{ }\mu\text{s}$	V_C	-	18.5	22.5	V
	At $I_{PP} = I_{PPM} = 15.5\text{ A}$; $t_p = 8/20\text{ }\mu\text{s}$		-	23.5	28.8	V
Forward clamping voltage	At $I_{PP} = 1\text{ A}$; $t_p = 8/20\text{ }\mu\text{s}$	V_F	-	1	1.2	V
	At $I_{PP} = I_{PPM} = 15.5\text{ A}$; $t_p = 8/20\text{ }\mu\text{s}$		-	2.2	-	V
Capacitance	At $V_R = 0\text{ V}$; $f = 1\text{ MHz}$	C_D	-	100	120	pF
	At $V_R = 7.5\text{ V}$; $f = 1\text{ MHz}$		-	43	-	pF

ELECTRICAL CHARACTERISTICS VGSOT22C ($T_{amb} = 25\text{ }^{\circ}\text{C}$ unless otherwise specified)						
PARAMETER	TEST CONDITIONS / REMARKS	SYMBOL	MIN.	TYP.	MAX.	UNIT
Protection paths	Number of lines which can be protected	$N_{channel}$	-	-	2	lines
Reverse stand-off voltage	Max. reverse working voltage	V_{RWM}	-	-	22	V
Reverse voltage	At $I_R = 1\text{ }\mu\text{A}$	V_R	22	-	-	V
Reverse current	At $V_R = 22\text{ V}$	I_R	-	-	1	μA
Reverse breakdown voltage	At $I_R = 1\text{ mA}$	V_{BR}	25.1	27	28.8	V
Reverse clamping voltage	At $I_{PP} = 1\text{ A}$; $t_p = 8/20\text{ }\mu\text{s}$	V_C	-	28	32	V
	At $I_{PP} = I_{PPM} = 9.4\text{ A}$; $t_p = 8/20\text{ }\mu\text{s}$		-	34.5	41	V
Forward clamping voltage	At $I_{PP} = 1\text{ A}$; $t_p = 8/20\text{ }\mu\text{s}$	V_F	-	1	1.2	V
	At $I_{PP} = I_{PPM} = 9.4\text{ A}$; $t_p = 8/20\text{ }\mu\text{s}$		-	1.8	-	V
Capacitance	At $V_R = 0\text{ V}$; $f = 1\text{ MHz}$	C_D	-	70	85	pF
	At $V_R = 11\text{ V}$; $f = 1\text{ MHz}$		-	27	-	pF



ELECTRICAL CHARACTERISTICS VGSOT24C ($T_{amb} = 25\text{ }^{\circ}\text{C}$ unless otherwise specified)						
PARAMETER	TEST CONDITIONS / REMARKS	SYMBOL	MIN.	TYP.	MAX.	UNIT
Protection paths	Number of lines which can be protected	$N_{channel}$	-	-	2	lines
Reverse stand-off voltage	Max. reverse working voltage	V_{RWM}	-	-	24	V
Reverse voltage	At $I_R = 1\text{ }\mu\text{A}$	V_R	24	-	-	V
Reverse current	At $V_R = 24\text{ V}$	I_R	-	-	1	μA
Reverse breakdown voltage	At $I_R = 1\text{ mA}$	V_{BR}	27	30	33	V
Reverse clamping voltage	At $I_{PP} = 1\text{ A}$; $t_p = 8/20\text{ }\mu\text{s}$	V_C	-	31	37	V
	At $I_{PP} = I_{PPM} = 8.4\text{ A}$; $t_p = 8/20\text{ }\mu\text{s}$		-	37.5	46	V
Forward clamping voltage	At $I_{PP} = 1\text{ A}$; $t_p = 8/20\text{ }\mu\text{s}$	V_F	-	1	1.2	V
	At $I_{PP} = I_{PPM} = 8.4\text{ A}$; $t_p = 8/20\text{ }\mu\text{s}$		-	1.7	-	V
Capacitance	At $V_R = 0\text{ V}$; $f = 1\text{ MHz}$	C_D	-	65	80	pF
	At $V_R = 12\text{ V}$; $f = 1\text{ MHz}$		-	23	-	pF

ELECTRICAL CHARACTERISTICS VGSOT36C ($T_{amb} = 25\text{ }^{\circ}\text{C}$ unless otherwise specified)						
PARAMETER	TEST CONDITIONS / REMARKS	SYMBOL	MIN.	TYP.	MAX.	UNIT
Protection paths	Number of lines which can be protected	$N_{channel}$	-	-	2	lines
Reverse stand-off voltage	Max. reverse working voltage	V_{RWM}	-	-	36	V
Reverse voltage	At $I_R = 1\text{ }\mu\text{A}$	V_R	36	-	-	V
Reverse current	At $V_R = 36\text{ V}$	I_R	-	-	1	μA
Reverse breakdown voltage	At $I_R = 1\text{ mA}$	V_{BR}	39	43	47	V
Reverse clamping voltage	At $I_{PP} = 1\text{ A}$; $t_p = 8/20\text{ }\mu\text{s}$	V_C	-	45	60	V
	At $I_{PP} = I_{PPM} = 5.6\text{ A}$; $t_p = 8/20\text{ }\mu\text{s}$		-	52	71	V
Forward clamping voltage	At $I_{PP} = 1\text{ A}$; $t_p = 8/20\text{ }\mu\text{s}$	V_F	-	1	1.2	V
	At $I_{PP} = I_{PPM} = 5.6\text{ A}$; $t_p = 8/20\text{ }\mu\text{s}$		-	1.4	-	V
Capacitance	At $V_R = 0\text{ V}$; $f = 1\text{ MHz}$	C_D	-	45	65	pF
	At $V_R = 18\text{ V}$; $f = 1\text{ MHz}$		-	14	-	pF

BiSy-MODE (1-line bidirectional symmetrical protection mode)

If a bipolar symmetrical protection device is needed the VGSOTxxC can also be used as a single line protection device. Therefore pin 1 has to be connected to the signal- or data-line (L1) and pin 2 to ground (or vice versa). Pin 3 must not be connected.

Positive and negative voltage transients will be clamped in the same way. The clamping current through the VGSOTxxC passes one diode in forward direction and the other one in reverse direction. The clamping voltage (V_C) is defined by the breakdown voltage (V_{BR}) level of one diode plus the forward voltage of the other diode plus the voltage drop at the series impedances (resistances and inductances) of the protection device.

Due to the same clamping levels in positive and negative direction the VGSOTxxC voltage clamping behaviour is bidirectional and symmetrical (BiSy).

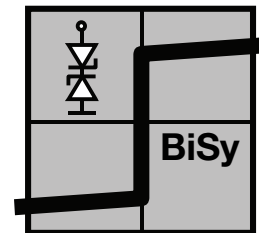
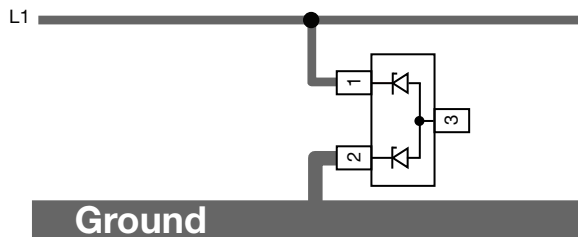

20361

ELECTRICAL CHARACTERISTICS VGSOT03C ($T_{amb} = 25\text{ }^{\circ}\text{C}$ unless otherwise specified) between pin 1 to pin 2 or pin 2 to pin1; pin 3 not connected						
PARAMETER	TEST CONDITIONS / REMARKS	SYMBOL	MIN.	TYP.	MAX.	UNIT
Protection paths	Number of lines which can be protected	$N_{channel}$	-	-	1	lines
Reverse stand-off voltage	Max. reverse working voltage	V_{RWM}	-	-	3.8	V
Reverse voltage	At $I_R = 100\text{ }\mu\text{A}$	V_R	3.8	-	-	V
Reverse current	At $V_R = 3.8\text{ V}$	I_R	-	-	100	μA
Reverse breakdown voltage	At $I_R = 1\text{ mA}$	V_{BR}	4.5	5.3	6.2	V
Reverse clamping voltage	At $I_{PP} = 1\text{ A}$, $t_p = 8/20\text{ }\mu\text{s}$	V_C	-	7	8.4	V
	At $I_{PP} = I_{PPM} = 44\text{ A}$, $t_p = 8/20\text{ }\mu\text{s}$		-	14	16.8	V
Capacitance	At $V_R = 0\text{ V}$; $f = 1\text{ MHz}$	C_D	-	230	300	pF
	At $V_R = 1.6\text{ V}$; $f = 1\text{ MHz}$		-	190	-	pF

ELECTRICAL CHARACTERISTICS VGSOT04C ($T_{amb} = 25\text{ }^{\circ}\text{C}$ unless otherwise specified) between pin 1 to pin 2 or pin 2 to pin1; pin 3 not connected						
PARAMETER	TEST CONDITIONS / REMARKS	SYMBOL	MIN.	TYP.	MAX.	UNIT
Protection paths	Number of lines which can be protected	$N_{channel}$	-	-	1	lines
Reverse stand-off voltage	Max. reverse working voltage	V_{RWM}	-	-	4.5	V
Reverse voltage	At $I_R = 20\text{ }\mu\text{A}$	V_R	4.5	-	-	V
Reverse current	At $V_R = 4.5\text{ V}$	I_R	-	-	20	μA
Reverse breakdown voltage	At $I_R = 1\text{ mA}$	V_{BR}	5.5	6.8	7.7	V
Reverse clamping voltage	At $I_{PP} = 1\text{ A}$, $t_p = 8/20\text{ }\mu\text{s}$	V_C	-	7.5	9	V
	At $I_{PP} = I_{PPM} = 40\text{ A}$, $t_p = 8/20\text{ }\mu\text{s}$		-	15.7	18.8	V
Capacitance	At $V_R = 0\text{ V}$; $f = 1\text{ MHz}$	C_D	-	180	225	pF
	At $V_R = 2\text{ V}$; $f = 1\text{ MHz}$		-	136	-	pF



ELECTRICAL CHARACTERISTICS VGSOT05C ($T_{amb} = 25\text{ }^{\circ}\text{C}$ unless otherwise specified) between pin 1 to pin 2 or pin 2 to pin1; pin 3 not connected						
PARAMETER	TEST CONDITIONS / REMARKS	SYMBOL	MIN.	TYP.	MAX.	UNIT
Protection paths	Number of lines which can be protected	$N_{channel}$	-	-	1	lines
Reverse stand-off voltage	Max. reverse working voltage	V_{RWM}	-	-	5.5	V
Reverse voltage	At $I_R = 10\text{ }\mu\text{A}$	V_R	5.5	-	-	V
Reverse current	At $V_R = 5.5\text{ V}$	I_R	-	-	10	μA
Reverse breakdown voltage	At $I_R = 1\text{ mA}$	V_{BR}	6.5	7.5	8.7	V
Reverse clamping voltage	At $I_{PP} = 1\text{ A}$, $t_p = 8/20\text{ }\mu\text{s}$	V_C	-	8.1	9.7	V
	At $I_{PP} = I_{PPM} = 36\text{ A}$, $t_p = 8/20\text{ }\mu\text{s}$		-	17	20.4	V
Capacitance	At $V_R = 0\text{ V}$; $f = 1\text{ MHz}$	C_D	-	138	175	pF
	At $V_R = 2.5\text{ V}$; $f = 1\text{ MHz}$		-	100	-	pF

ELECTRICAL CHARACTERISTICS VGSOT08C ($T_{amb} = 25\text{ }^{\circ}\text{C}$ unless otherwise specified) between pin 1 to pin 2 or pin 2 to pin1; pin 3 not connected						
PARAMETER	TEST CONDITIONS / REMARKS	SYMBOL	MIN.	TYP.	MAX.	UNIT
Protection paths	Number of lines which can be protected	$N_{channel}$	-	-	1	lines
Reverse stand-off voltage	Max. reverse working voltage	V_{RWM}	-	-	8.5	V
Reverse voltage	At $I_R = 5\text{ }\mu\text{A}$	V_R	8.5	-	-	V
Reverse current	At $V_R = 8.5\text{ V}$	I_R	-	-	5	μA
Reverse breakdown voltage	At $I_R = 1\text{ mA}$	V_{BR}	9.5	10.7	11.7	V
Reverse clamping voltage	At $I_{PP} = 1\text{ A}$, $t_p = 8/20\text{ }\mu\text{s}$	V_C	-	11.7	14	V
	At $I_{PP} = I_{PPM} = 28\text{ A}$, $t_p = 8/20\text{ }\mu\text{s}$		-	18.5	22.2	V
Capacitance	At $V_R = 0\text{ V}$; $f = 1\text{ MHz}$	C_D	-	87	125	pF
	At $V_R = 4\text{ V}$; $f = 1\text{ MHz}$		-	60	-	pF

ELECTRICAL CHARACTERISTICS VGSOT12C ($T_{amb} = 25\text{ }^{\circ}\text{C}$ unless otherwise specified) between pin 1 to pin 2 or pin 2 to pin1; pin 3 not connected						
PARAMETER	TEST CONDITIONS / REMARKS	SYMBOL	MIN.	TYP.	MAX.	UNIT
Protection paths	Number of lines which can be protected	$N_{channel}$	-	-	1	lines
Reverse stand-off voltage	Max. reverse working voltage	V_{RWM}	-	-	12.5	V
Reverse voltage	At $I_R = 1\text{ }\mu\text{A}$	V_R	12.5	-	-	V
Reverse current	At $V_R = 12.5\text{ V}$	I_R	-	-	1	μA
Reverse breakdown voltage	At $I_R = 1\text{ mA}$	V_{BR}	13.5	15.7	16.5	V
Reverse clamping voltage	At $I_{PP} = 1\text{ A}$, $t_p = 8/20\text{ }\mu\text{s}$	V_C	-	16.4	19.7	V
	At $I_{PP} = I_{PPM} = 18.5\text{ A}$, $t_p = 8/20\text{ }\mu\text{s}$		-	23.4	28.1	V
Capacitance	At $V_R = 0\text{ V}$; $f = 1\text{ MHz}$	C_D	-	58	75	pF
	At $V_R = 6\text{ V}$; $f = 1\text{ MHz}$		-	36	-	pF



ELECTRICAL CHARACTERISTICS VGSOT15C ($T_{amb} = 25\text{ }^{\circ}\text{C}$ unless otherwise specified) between pin 1 to pin 2 or pin 2 to pin1; pin 3 not connected						
PARAMETER	TEST CONDITIONS / REMARKS	SYMBOL	MIN.	TYP.	MAX.	UNIT
Protection paths	Number of lines which can be protected	$N_{channel}$	-	-	1	lines
Reverse stand-off voltage	Max. reverse working voltage	V_{RWM}	-	-	15.5	V
Reverse voltage	At $I_R = 1\text{ }\mu\text{A}$	V_R	15.5	-	-	V
Reverse current	At $V_R = 15.5\text{ V}$	I_R	-	-	1	μA
Reverse breakdown voltage	At $I_R = 1\text{ mA}$	V_{BR}	17	18.7	20.7	V
Reverse clamping voltage	At $I_{PP} = 1\text{ A}$, $t_p = 8/20\text{ }\mu\text{s}$	V_C	-	20.4	24.5	V
	At $I_{PP} = I_{PPM} = 15.5\text{ A}$, $t_p = 8/20\text{ }\mu\text{s}$		-	26.6	30.6	V
Capacitance	At $V_R = 0\text{ V}$; $f = 1\text{ MHz}$	C_D	-	50	60	pF
	At $V_R = 7.5\text{ V}$; $f = 1\text{ MHz}$		-	30	-	pF

ELECTRICAL CHARACTERISTICS VGSOT22C ($T_{amb} = 25\text{ }^{\circ}\text{C}$ unless otherwise specified) between pin 1 to pin 2 or pin 2 to pin1; pin 3 not connected						
PARAMETER	TEST CONDITIONS / REMARKS	SYMBOL	MIN.	TYP.	MAX.	UNIT
Protection paths	Number of lines which can be protected	$N_{channel}$	-	-	1	lines
Reverse stand-off voltage	Max. reverse working voltage	V_{RWM}	-	-	22.5	V
Reverse voltage	At $I_R = 1\text{ }\mu\text{A}$	V_R	22.5	-	-	V
Reverse current	At $V_R = 22.5\text{ V}$	I_R	-	-	1	μA
Reverse breakdown voltage	At $I_R = 1\text{ mA}$	V_{BR}	25.6	27.7	29.5	V
Reverse clamping voltage	At $I_{PP} = 1\text{ A}$, $t_p = 8/20\text{ }\mu\text{s}$	V_C	-	29	33.2	V
	At $I_{PP} = I_{PPM} = 9.4\text{ A}$, $t_p = 8/20\text{ }\mu\text{s}$		-	-	-	V
Capacitance	At $V_R = 0\text{ V}$; $f = 1\text{ MHz}$	C_D	-	35	43	pF
	At $V_R = 11\text{ V}$; $f = 1\text{ MHz}$		-	20	-	pF

ELECTRICAL CHARACTERISTICS VGSOT24C ($T_{amb} = 25\text{ }^{\circ}\text{C}$ unless otherwise specified) between pin 1 to pin 2 or pin 2 to pin1; pin 3 not connected						
PARAMETER	TEST CONDITIONS / REMARKS	SYMBOL	MIN.	TYP.	MAX.	UNIT
Protection paths	Number of lines which can be protected	$N_{channel}$	-	-	1	lines
Reverse stand-off voltage	Max. reverse working voltage	V_{RWM}	-	-	24.5	V
Reverse voltage	At $I_R = 1\text{ }\mu\text{A}$	V_R	24.5	-	-	V
Reverse current	At $V_R = 24.5\text{ V}$	I_R	-	-	1	μA
Reverse breakdown voltage	At $I_R = 1\text{ mA}$	V_{BR}	27.5	30.7	33.7	V
Reverse clamping voltage	At $I_{PP} = 1\text{ A}$, $t_p = 8/20\text{ }\mu\text{s}$	V_C	-	34	41	V
	At $I_{PP} = I_{PPM} = 8.4\text{ A}$, $t_p = 8/20\text{ }\mu\text{s}$		-	40	48	V
Capacitance	At $V_R = 0\text{ V}$; $f = 1\text{ MHz}$	C_D	-	33	40	pF
	At $V_R = 12\text{ V}$; $f = 1\text{ MHz}$		-	17	-	pF

ELECTRICAL CHARACTERISTICS VGSOT36C ($T_{amb} = 25\text{ }^{\circ}\text{C}$ unless otherwise specified) between pin 1 to pin 2 or pin 2 to pin1; pin 3 not connected						
PARAMETER	TEST CONDITIONS / REMARKS	SYMBOL	MIN.	TYP.	MAX.	UNIT
Protection paths	Number of lines which can be protected	$N_{channel}$	-	-	1	lines
Reverse stand-off voltage	Max. reverse working voltage	V_{RWM}	-	-	36.5	V
Reverse voltage	At $I_R = 1\text{ }\mu\text{A}$	V_R	36.5	-	-	V
Reverse current	At $V_R = 36.5\text{ V}$	I_R	-	-	1	μA
Reverse breakdown voltage	At $I_R = 1\text{ mA}$	V_{BR}	39.5	43.7	47.7	V
Reverse clamping voltage	At $I_{PP} = 1\text{ A}$, $t_p = 8/20\text{ }\mu\text{s}$	V_C	-	50	60	V
	At $I_{PP} = I_{PPM} = 5.6\text{ A}$, $t_p = 8/20\text{ }\mu\text{s}$		-	60	72	V
Capacitance	At $V_R = 0\text{ V}$; $f = 1\text{ MHz}$	C_D	-	23	33	pF
	At $V_R = 18\text{ V}$; $f = 1\text{ MHz}$		-	10	-	pF

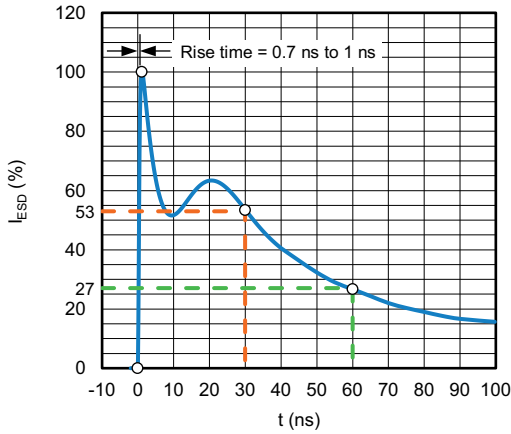

Fig. 1 - ESD Discharge Current Waveform According to IEC 61000-4-2 (330 Ω / 150 pF)

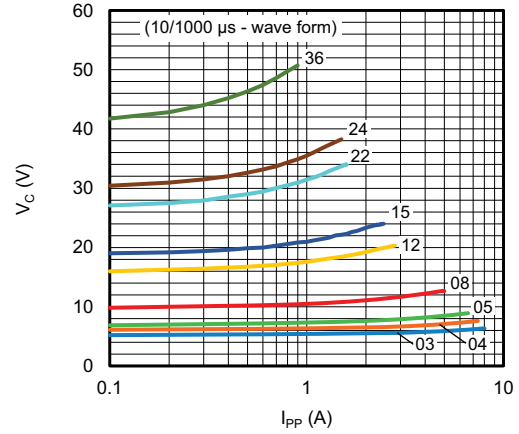

Fig. 4 - Typical Peak Clamping Voltage vs. Peak Pulse Current

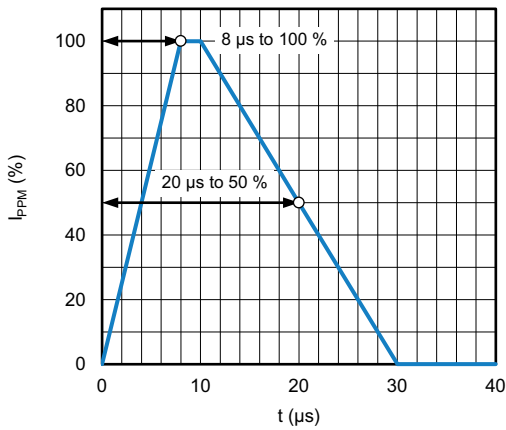

Fig. 2 - 8/20 μs Peak Pulse Current Waveform According to IEC 61000-4-5

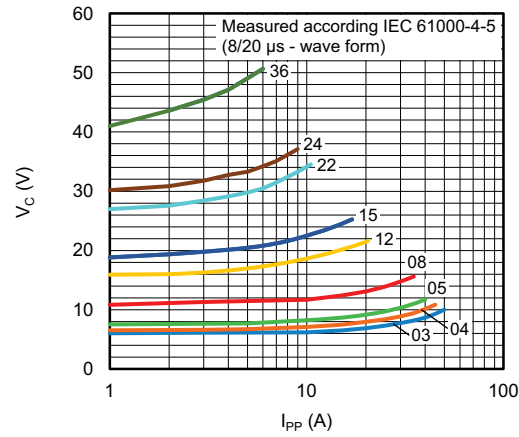

Fig. 5 - Typical Peak Clamping Voltage vs. Peak Pulse Current

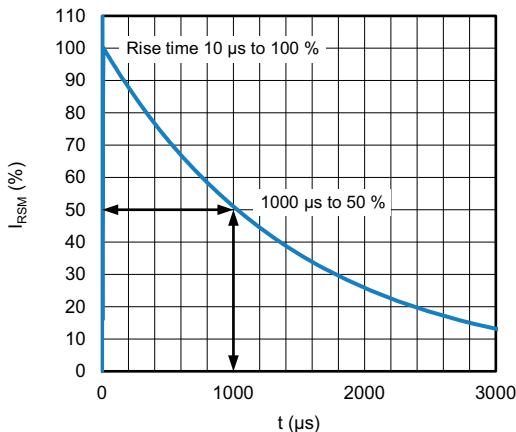

Fig. 3 - 10/1000 μs Peak Pulse Current Wave Form

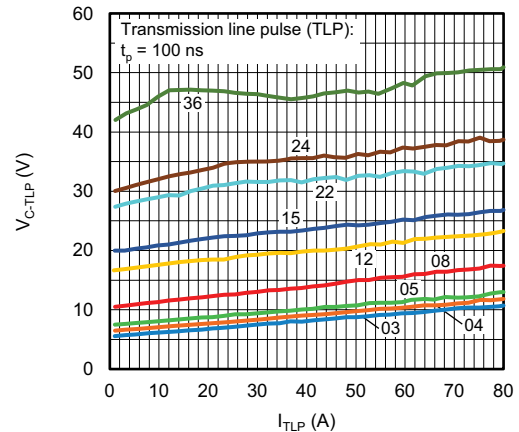

Fig. 6 - Typical Clamping Voltage vs. Peak Pulse Current

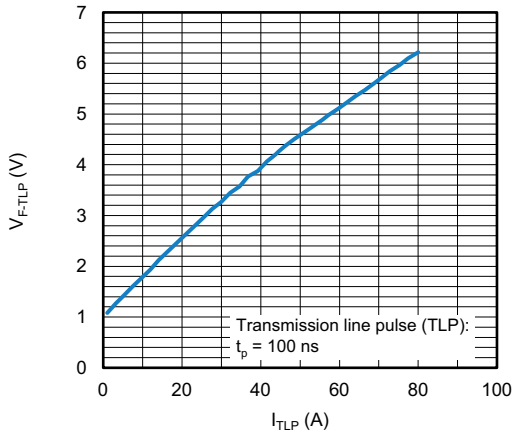

Fig. 7 - Typical Forward Voltage vs. Peak Pulse Current

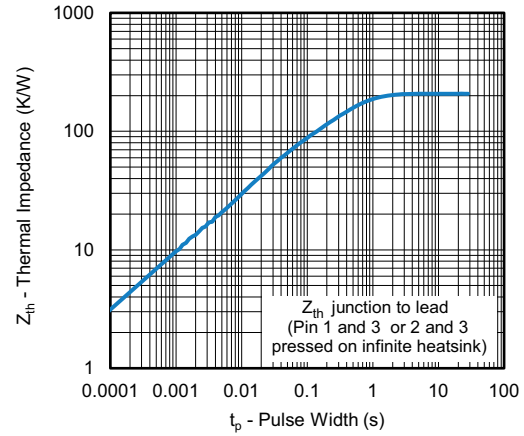

Fig. 10 - Thermal Impedance vs. Time

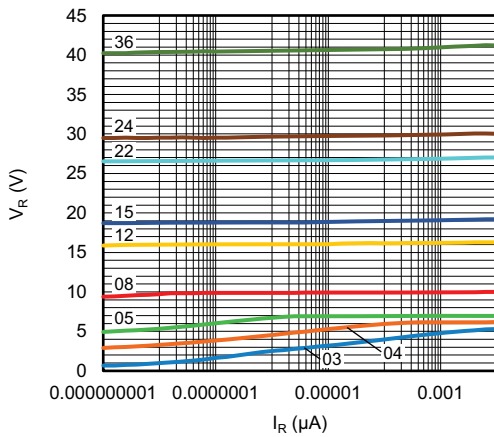

Fig. 8 - Typical Reverse Voltage vs. Reverse Current

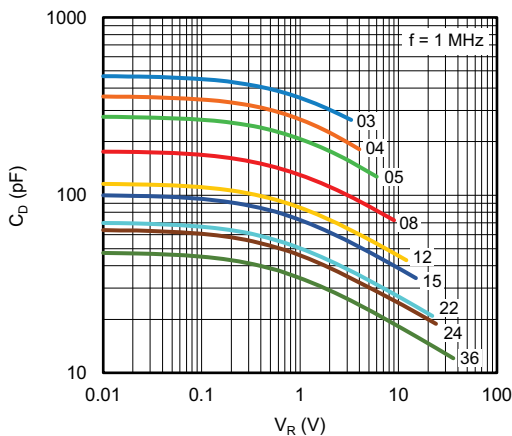
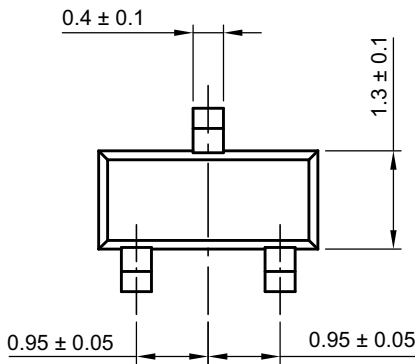
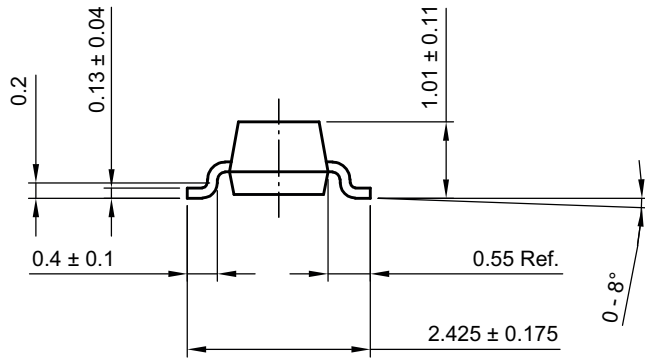
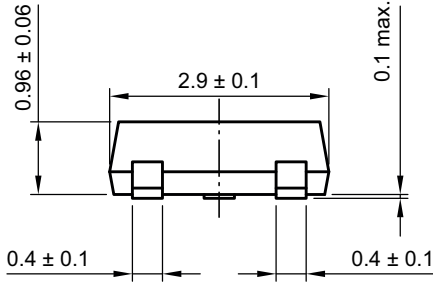

Fig. 9 - Typical Capacitance vs. Reverse Voltage



PACKAGE DIMENSIONS in millimeters (inches): SOT-23



footprint recommendation:

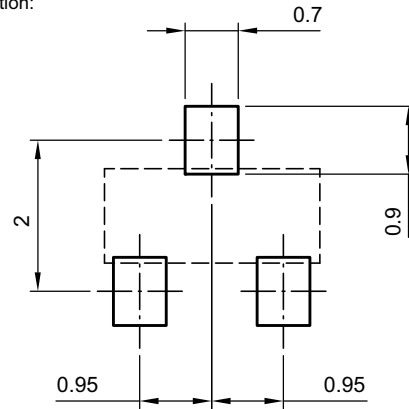

Document no.: S8-V-3929.01-009 (4)
Created - Date: 18 Oct. 2021
Rev. 01 - Date: 18 Jan. 2022

23193

ORIENTATION IN CARRIER TAPE SOT-23

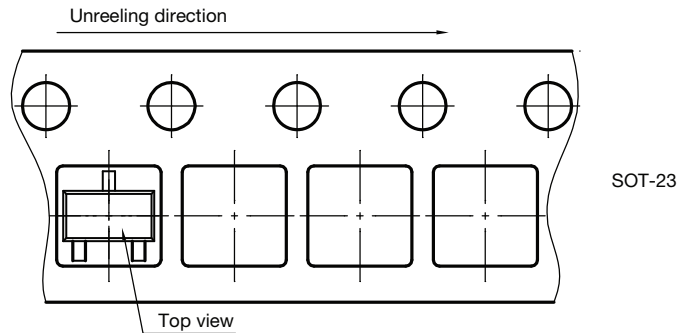

Orientation in carrier tape
SOT-23
S8-V-3929.01-006 (4)
04.02.2010
22607



Disclaimer

ALL PRODUCT, PRODUCT SPECIFICATIONS AND DATA ARE SUBJECT TO CHANGE WITHOUT NOTICE TO IMPROVE RELIABILITY, FUNCTION OR DESIGN OR OTHERWISE.

Vishay Intertechnology, Inc., its affiliates, agents, and employees, and all persons acting on its or their behalf (collectively, "Vishay"), disclaim any and all liability for any errors, inaccuracies or incompleteness contained in any datasheet or in any other disclosure relating to any product.

Vishay makes no warranty, representation or guarantee regarding the suitability of the products for any particular purpose or the continuing production of any product. To the maximum extent permitted by applicable law, Vishay disclaims (i) any and all liability arising out of the application or use of any product, (ii) any and all liability, including without limitation special, consequential or incidental damages, and (iii) any and all implied warranties, including warranties of fitness for particular purpose, non-infringement and merchantability.

Statements regarding the suitability of products for certain types of applications are based on Vishay's knowledge of typical requirements that are often placed on Vishay products in generic applications. Such statements are not binding statements about the suitability of products for a particular application. It is the customer's responsibility to validate that a particular product with the properties described in the product specification is suitable for use in a particular application. Parameters provided in datasheets and / or specifications may vary in different applications and performance may vary over time. All operating parameters, including typical parameters, must be validated for each customer application by the customer's technical experts. Product specifications do not expand or otherwise modify Vishay's terms and conditions of purchase, including but not limited to the warranty expressed therein.

Hyperlinks included in this datasheet may direct users to third-party websites. These links are provided as a convenience and for informational purposes only. Inclusion of these hyperlinks does not constitute an endorsement or an approval by Vishay of any of the products, services or opinions of the corporation, organization or individual associated with the third-party website. Vishay disclaims any and all liability and bears no responsibility for the accuracy, legality or content of the third-party website or for that of subsequent links.

Vishay products are not designed for use in life-saving or life-sustaining applications or any application in which the failure of the Vishay product could result in personal injury or death unless specifically qualified in writing by Vishay. Customers using or selling Vishay products not expressly indicated for use in such applications do so at their own risk. Please contact authorized Vishay personnel to obtain written terms and conditions regarding products designed for such applications.

No license, express or implied, by estoppel or otherwise, to any intellectual property rights is granted by this document or by any conduct of Vishay. Product names and markings noted herein may be trademarks of their respective owners.

单击下面可查看定价，库存，交付和生命周期等信息

[>>Vishay\(威世\)](#)