

28 V, 56 mΩ, Load Switch with Programmable Current Limit and Slew Rate Control

OPERATION DESCRIPTION

SiP32419 and SiP32429 are load switches that integrate multiple control features that simplify the design and increase the reliability of the circuitry connected to the switch. Both devices are 56 mΩ switches designed to operate in the 6 V to 28 V range. An internally generated gate drive voltage ensures good R_{ON} linearity over the input voltage operating range.

The SiP32419 and SiP32429 have a slew rate control circuit that controls the switch turn-on time to the value set by an external capacitor.

After soft start, an over-current protection circuit (OCP) continuously monitors the current through the load switch, and controls the switch impedance to limit the current to the level programmed by an external resistor. If the over-current condition persists for more than 7 ms, the switch shuts off automatically. The SiP32419 and SiP32429 has an over temperature protection circuit (OTP) which will shut the switch off if the junction temperature exceeds about 135 °C. The OTP circuit will release the switch when the temperature has decreased by about 40 °C of hysteresis.

When an OCP or an OTP fault condition is detected the FLG pin is pulled low. For the SiP32429, the fault flag will release 150 ms after the fault condition is cleared, and the switch will automatically turn on at the programmed slew rate. For the SiP32419, the switch will remain off and the fault flag will remain on. The switch will be reset by toggling either control signal on EN pin or the input power if it is not under over temperature fault condition.

These devices feature a low voltage control logic interface which can be controlled without the need for level shifting. These devices also include a power good flag.

SiP32419 and SiP32429 are available in a space efficient DFN10 3 mm x 3 mm package.

FEATURES

- 6 V to 28 V operation voltage
- 56 mΩ typical on resistance
- Programmable soft start
- Programmable current limit
- Programmable soft start control
- Over temperature protection
- Power good, when V_{OUT} reaches 90 % of V_{IN}
- Fault flag on for thermal shutdown and OCP
- Under voltage lockout: 4.8 V / 5.4 V (typ. / max.)
- Auto-retry SiP32429 and latch-off SiP32419 versions
- Package: DFN-10 3 mm x 3 mm
- IEC 62368-1 certified
- Material categorization: for definitions of compliance please see www.vishay.com/doc?99912



APPLICATIONS

- eFuse, smart load switch
- White goods, appliances
- Flat panel displays
- Set top boxes, game consoles
- Smart meters, medical analyzers
- Industrial 4.0 IoT
- Telecom network
- RF LNA power
- SSD drive, data storage

TYPICAL APPLICATION CIRCUIT

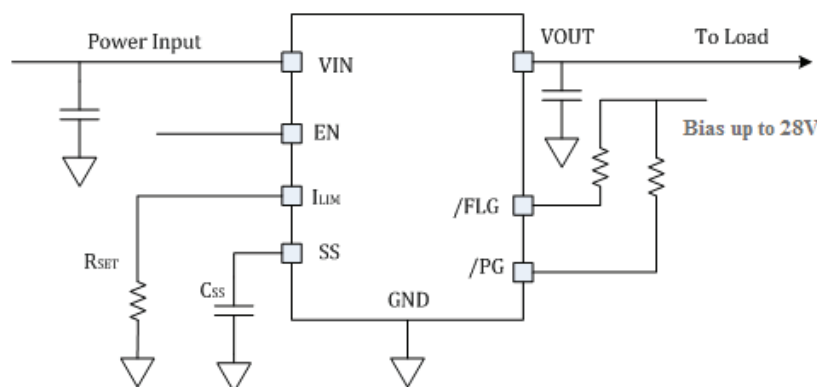


Fig. 1 - SiP32419, SiP32429 Typical Application Circuit



ORDERING INFORMATION				
TEMPERATURE RANGE	PACKAGE	MARKING	PART NUMBER	OCP
-40 °C to +85 °C	DFN10 3 mm x 3 mm	2429	SiP32429DN-T1-GE4	Auto-retry
		2419	SiP32419DN-T1-GE4	Latch-off

Note

- GE4 denotes halogen-free and RoHS-compliant

ABSOLUTE MAXIMUM RATINGS		
PARAMETER	LIMIT	UNIT
Input voltage (V_{IN})	-0.3 to 30	V
Output voltage (V_{OUT})	-0.3 to $V_{IN} + 0.3$ V	
	-5 V for 5 μ s	
PG voltage	-0.3 to +30	
FLG voltage	-0.3 to +30	
EN voltage	-0.3 to +6	
Maximum continuous switch current	4.5	A
ESD rating (HBM)	4000	V
Maximum junction temperature	150	°C
Storage temperature	-55 to +150	
Thermal resistance (θ_{JA}) ^a	88	°C/W
Power dissipation (P_D) ^{a, b}	1.42	W

Notes

- a. Device mounted with all lead and power pad soldered or welded to PCB
- b. Derate 11.4 mW/°C above $T_A = 25$ °C

Stresses beyond those listed under "Absolute Maximum Ratings" may cause permanent damage to the device. These are stress ratings only, and functional operation of the device at these or any other conditions beyond those indicated in the operational sections of the specifications is not implied. Exposure to absolute maximum rating conditions for extended periods may affect device reliability.

RECOMMENDED OPERATING RANGE		
PARAMETER	LIMIT	UNIT
Input voltage (V_{IN})	6 to 28	V
V_{SS}	0 to 6	
V_{OUT}	0 to 28	
EN	0 to 6	
FLG, \overline{PG}	0 to V_{IN}	
I_{LIM}	0 to 6	
Current limit	0.75 to 3.5	A
Operating temperature range	-40 to +85	°C



SPECIFICATIONS							
PARAMETER	SYMBOL	TEST CONDITIONS UNLESS SPECIFIED $V_{IN} = 12\text{ V}$, $V_{EN} = 2.4\text{ V}$, $T_A = 25\text{ }^\circ\text{C}$	TEMP.	MIN.	TYP.	MAX.	UNIT
Power input voltage	V_{IN}		-	6	-	28	V
Quiescent current	I_Q	$I_{OUT} = 0\text{ A}$ and device enabled	-	-	170	300	μA
Shutdown current	I_{SD}	$I_{OUT} = 0\text{ A}$ and device disabled	-	-	12	20	
Switch off leakage	$I_{(OFF)}$	$V_{IN} = 28\text{ V}$, $V_{OUT} = 0\text{ V}$ (current measured at output)	-	-	-	1	
Current limit accuracy		$R_{SET} = 4.1\text{ k}\Omega$	$-40\text{ }^\circ\text{C}$ to $+85\text{ }^\circ\text{C}$	1.2	1.5	1.8	A
Switch on resistance	$R_{DS(on)}$	$I_{SW} = 500\text{ mA}$	-	-	56	72	$\text{m}\Omega$
Soft start charge current	I_{SS}	Constant current source	-	-	4.5	-	μA
Turn on delay time	T_{ON_DLY}	50 % V_{EN} to 50 % V_{OUT} , $C_{SS} = \text{open}$, $R_L = 10\text{ }\Omega$, $C_{OUT} = 10\text{ }\mu\text{F}$	-	-	550	-	μs
Turn on rise time	T_R	$C_{SS} = \text{open}$, $R_L = 10\text{ }\Omega$, $C_{OUT} = 10\text{ }\mu\text{F}$	-	-	400	-	
		$C_{SS} = 47\text{ nF}$, $R_L = 10\text{ }\Omega$, $C_{OUT} = 10\text{ }\mu\text{F}$	-	-	7	-	
		$C_{SS} = 47\text{ nF}$, no R_L , $C_{OUT} = 10\text{ }\mu\text{F}$	-	-	2	-	
Turn off delay	T_{OFF_DLY}		-	-	1	-	μs
Current limit response time			-	-	20	-	
Short circuit response time			-	-	1	-	
OC flag blanking time / switch off delay under OC			$-40\text{ }^\circ\text{C}$ to $+85\text{ }^\circ\text{C}$	4	-	-	ms
Auto-retry time (SiP32429 only)			-	-	150	-	
Input logic high voltage	V_{ENH}	$V_{IN} = 6\text{ V}$ to 28 V	$-40\text{ }^\circ\text{C}$ to $+85\text{ }^\circ\text{C}$	1.5	-	-	V
Input logic low voltage	V_{ENL}		$-40\text{ }^\circ\text{C}$ to $+85\text{ }^\circ\text{C}$	-	-	0.6	
Input pull down resistor	R_{EN}	$V_{EN} = 5\text{ V}$	$25\text{ }^\circ\text{C}$	1.5	2.5	3.9	$\text{M}\Omega$
			$-40\text{ }^\circ\text{C}$ to $+85\text{ }^\circ\text{C}$	0.7	-	4.5	
Power good trip voltage			-	-	$90\% \times V_{IN}$	-	V
Power good hysteresis			-	-	$3\% \times V_{IN}$	-	
$\overline{\text{PG}}$ and $\overline{\text{FLG}}$ output logic low voltage		$I_{SINK} = 1\text{ mA}$	-	-	< 0.1	-	
$\overline{\text{PG}}$ and $\overline{\text{FLG}}$ output high leakage		V_{PG} , $V_{FLG} = 28\text{ V}$	-	-	-	1	μA
UVLO threshold			-	-	4.8	5.4	V
UVLO hysteresis			-	-	0.28	-	
Thermal shutdown threshold			-	-	137	-	$^\circ\text{C}$
Thermal shutdown hysteresis			-	-	39	-	

TIMING DIAGRAM

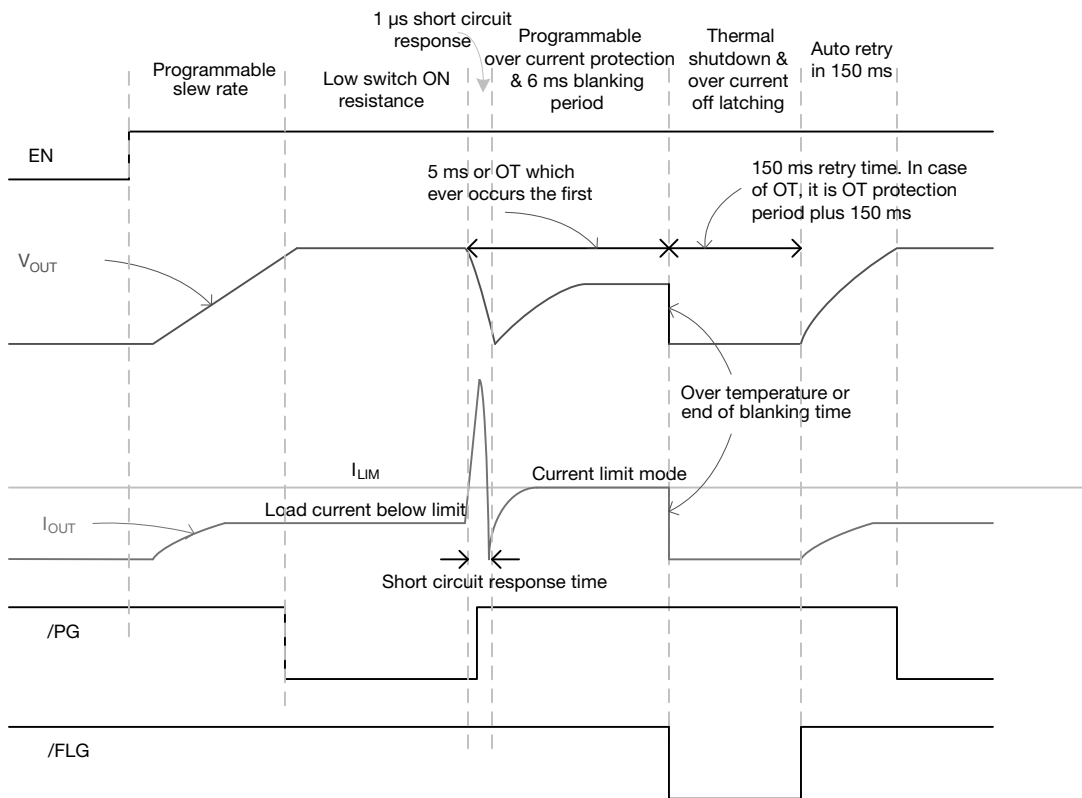


Fig. 2 - Timing Diagram

PIN CONFIGURATION

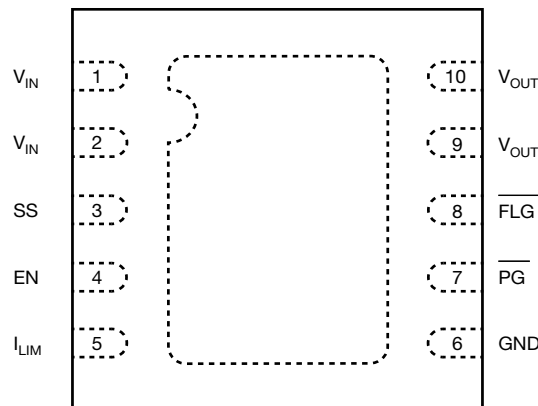


Fig. 3 - DFN10 3 mm x 3 mm Package
Top View

PIN DESCRIPTION		
PIN NUMBER	NAME	FUNCTION
1	V_{IN}	Power input
2	V_{IN}	Power input
3	SS	Soft-start pin. Connect a capacitor from SS to GND to program the soft-start time. Leave SS open to set the default soft-start time of 400 μ s
4	EN	Enable input. Logic high enabled
5	I_{LIM}	Current limit setting pin. Connect R_{SET} resistor to GND
6	GND	Ground
7	\overline{PG}	Power good
8	\overline{FLG}	Fault condition flag
9	V_{OUT}	Switch output
10	V_{OUT}	Switch output
Central pad		Connect this pad to GND or leave it floating

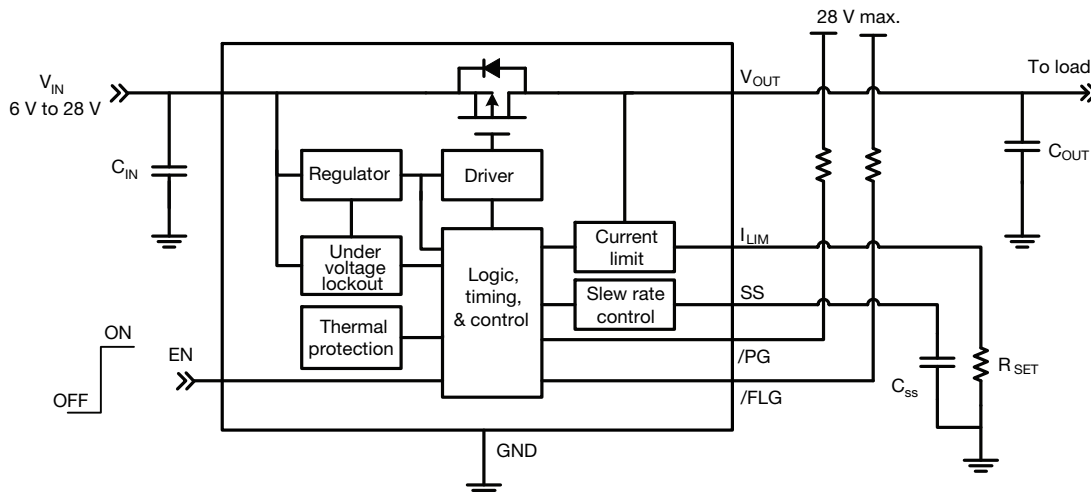
BLOCK DIAGRAM


Fig. 4 - Block Diagram

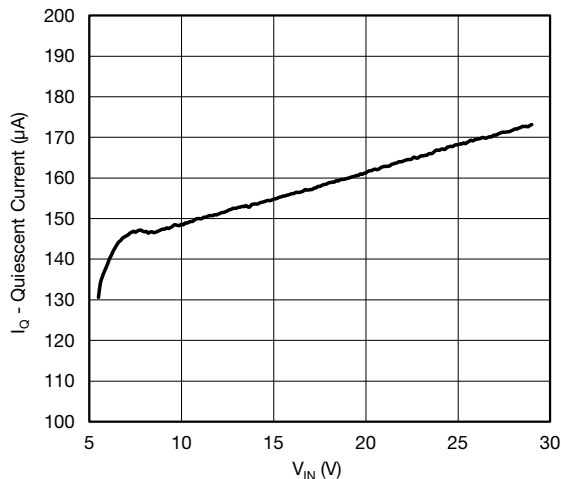
TYPICAL CHARACTERISTICS (internally regulated, 25 °C, unless otherwise noted)


Fig. 5 - Quiescent Current vs. Input Voltage

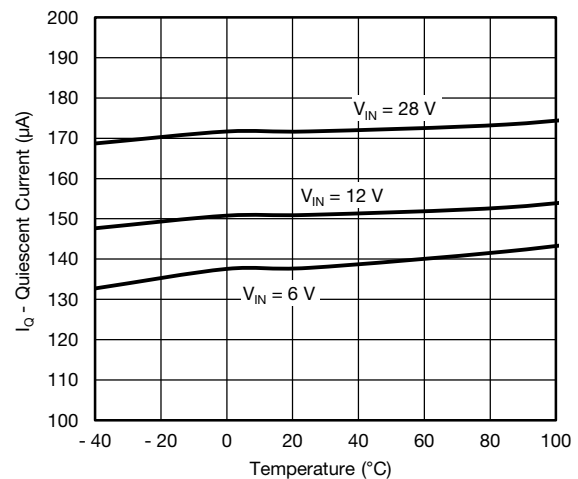


Fig. 6 - Quiescent Current vs. Temperature



TYPICAL CHARACTERISTICS (internally regulated, 25 °C, unless otherwise noted)

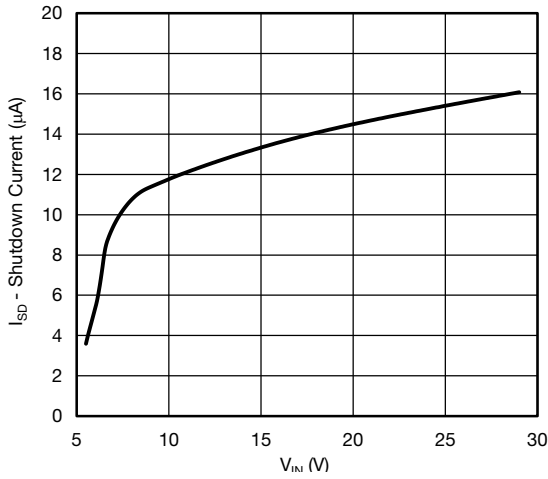


Fig. 7 - Shutdown Current vs. Input Voltage

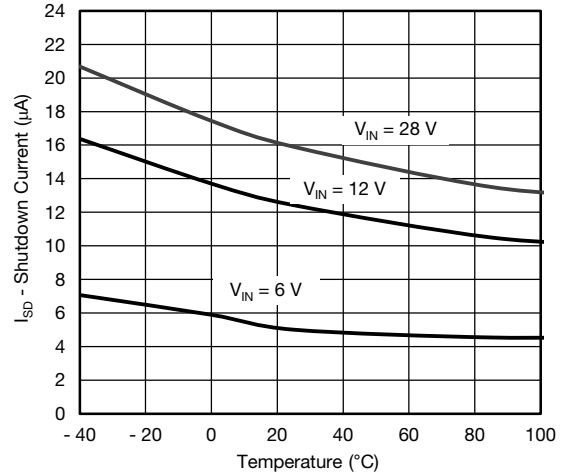


Fig. 10 - Shutdown Current vs. Temperature

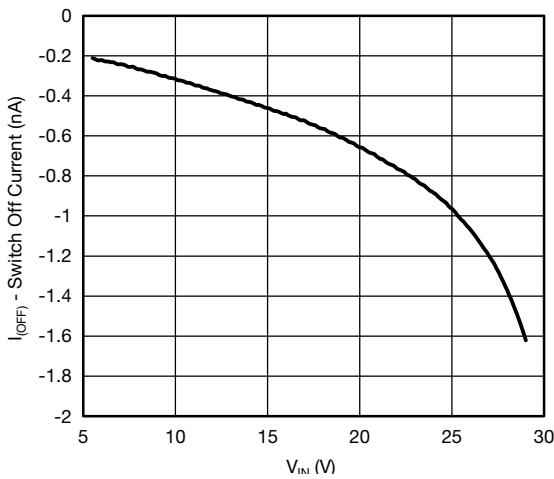


Fig. 8 - Shutdown Current vs. Input Voltage

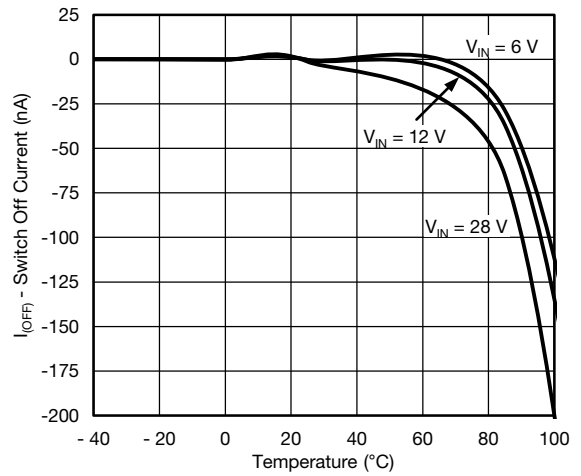


Fig. 11 - Switch Off Current vs. Temperature

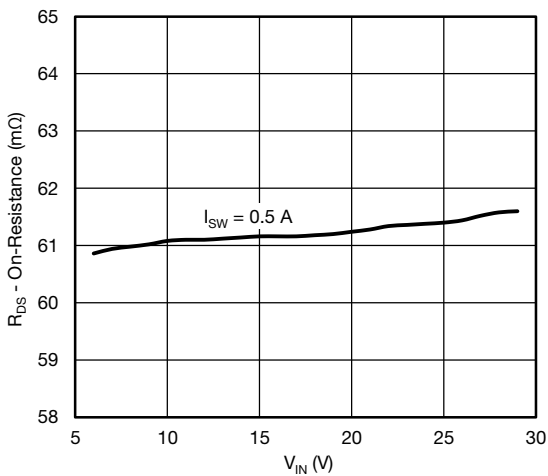


Fig. 9 - On Resistance vs. Input Voltage

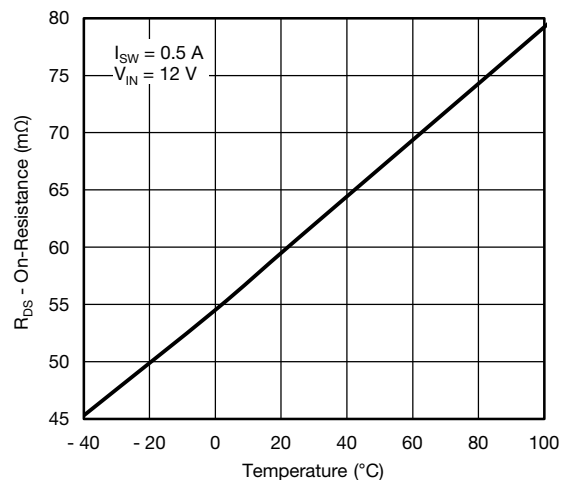
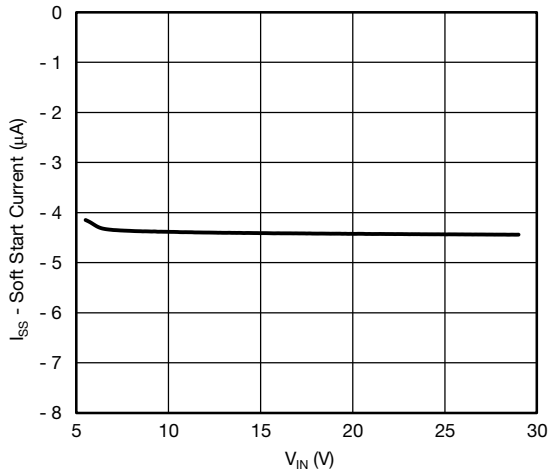
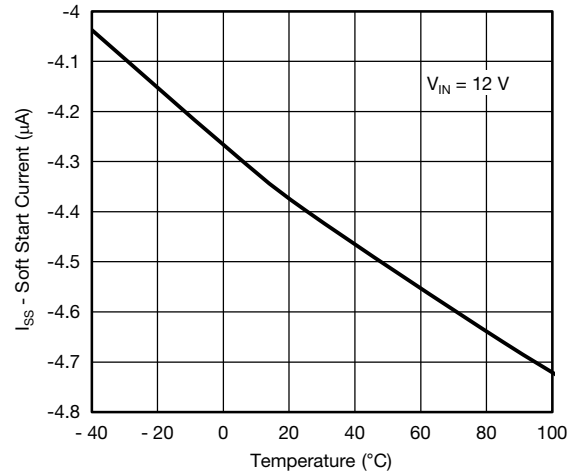
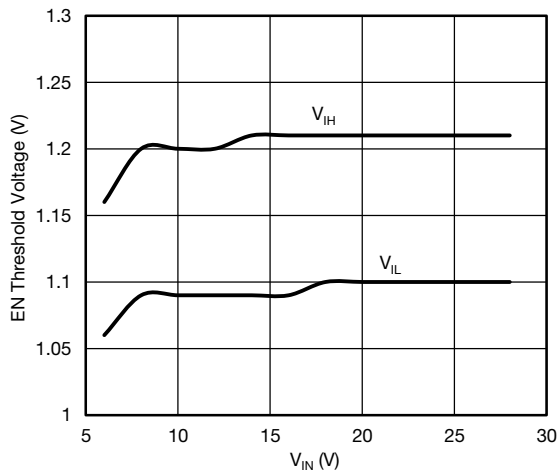
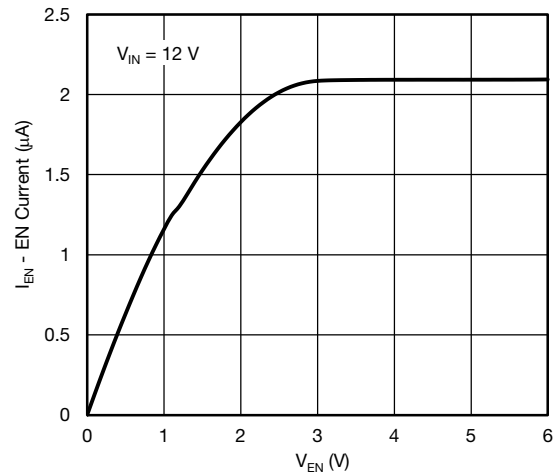


Fig. 12 - On Resistance vs. Temperature

TYPICAL CHARACTERISTICS (internally regulated, 25 °C, unless otherwise noted)

Fig. 13 - Soft Start Current vs. Input Voltage

Fig. 15 - Soft Start Current vs. Temperature

Fig. 14 - Threshold Voltage vs. Input Voltage

Fig. 16 - EN Current vs. V_{EN}

TYPICAL CHARACTERISTICS (internally regulated, 25 °C, unless otherwise noted)

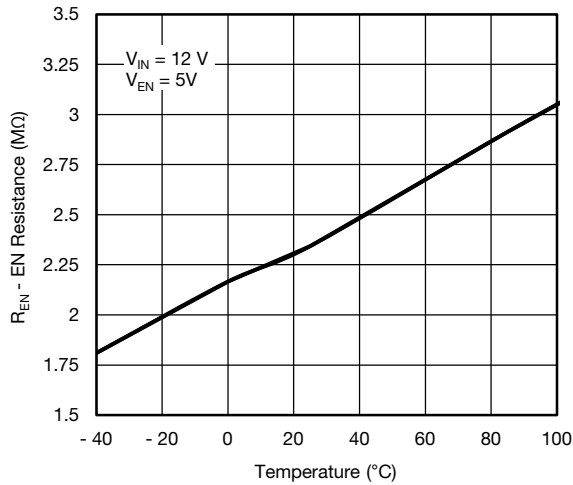


Fig. 17 - EN Resistance vs. Temperature

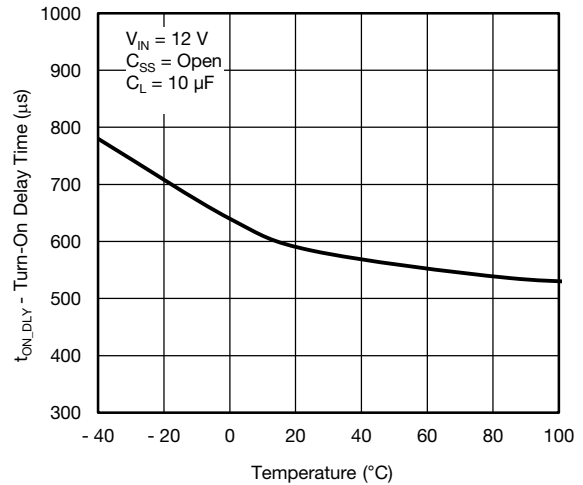


Fig. 19 - Turn-On Delay Time vs. Temperature

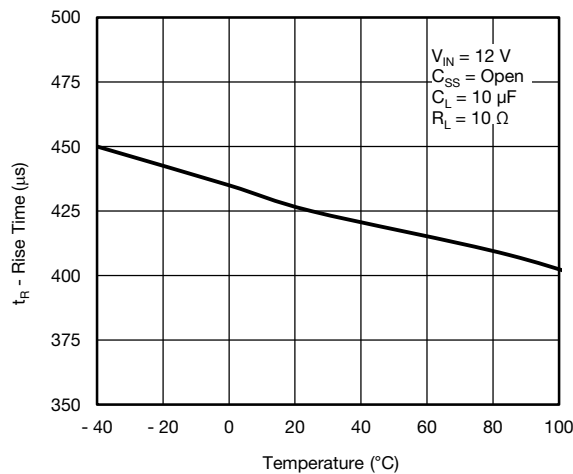


Fig. 18 - Rise Time vs. Temperature

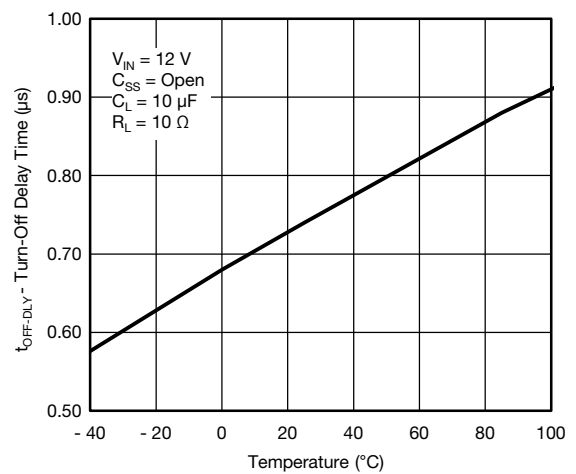


Fig. 20 - Turn-Off Delay Time vs. Temperature

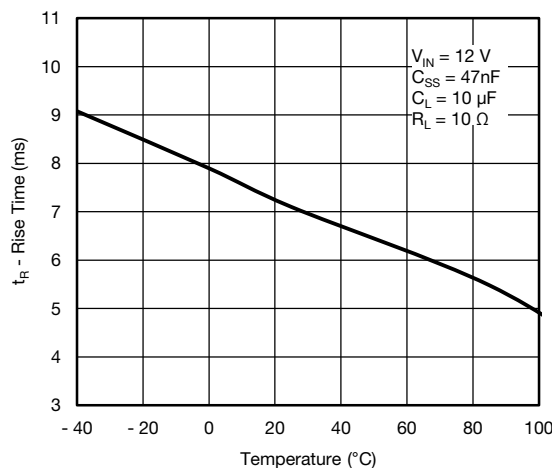


Fig. 21 - Rise Time vs. Temperature

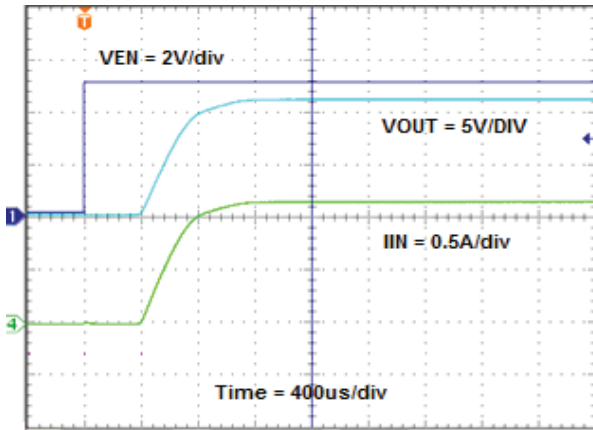
TYPICAL WAVEFORMS


Fig. 22 - Turn-On Time,
 $V_{IN} = 12\text{ V}$, $C_{SS} = \text{open}$, $R_L = 10\ \Omega$, $C_L = 10\ \mu\text{F}$

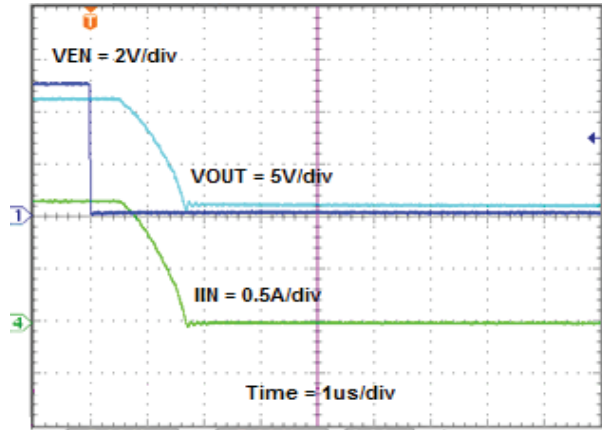


Fig. 25 - Turn-Off Time,
 $V_{IN} = 12\text{ V}$, $C_{SS} = \text{open}$, $R_L = 10\ \Omega$, $C_L = 10\ \mu\text{F}$

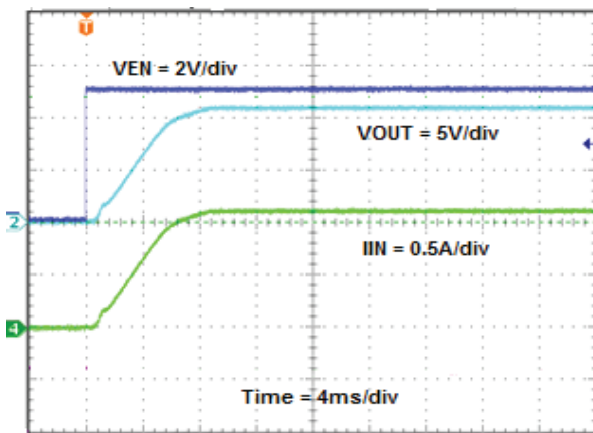


Fig. 23 - Turn-On Time,
 $V_{IN} = 12\text{ V}$, $C_{SS} = 47\text{ nF}$, $R_L = 10\ \Omega$, $C_L = 10\ \mu\text{F}$

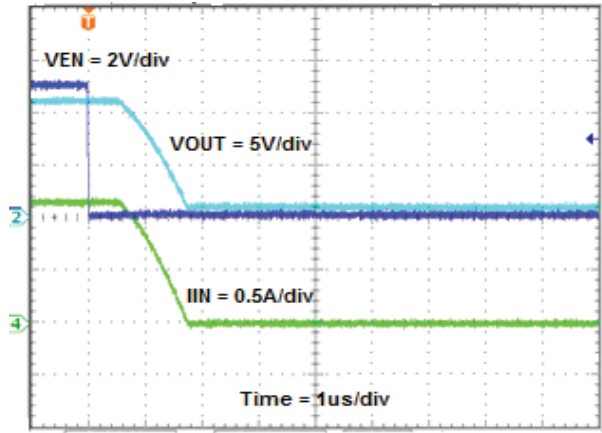


Fig. 26 - Turn-Off Time,
 $V_{IN} = 12\text{ V}$, $C_{SS} = 47\text{ nF}$, $R_L = 10\ \Omega$, $C_L = 10\ \mu\text{F}$

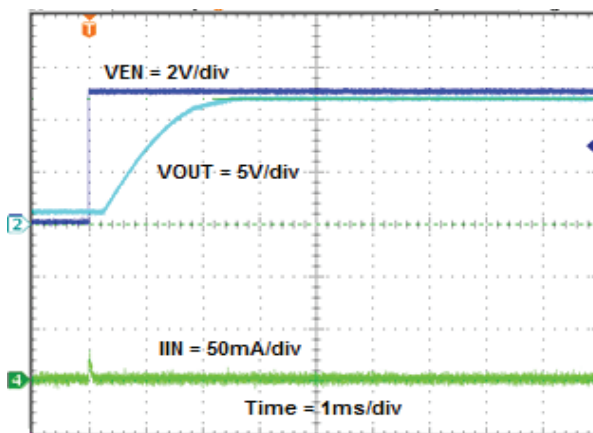


Fig. 24 - Turn-On Time,
 $V_{IN} = 12\text{ V}$, $C_{SS} = 47\text{ nF}$, $R_L = \text{open}$, $C_L = 10\ \mu\text{F}$

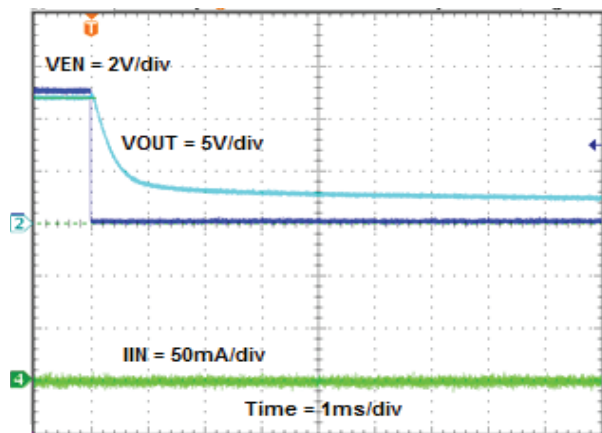


Fig. 27 - Turn-Off Time,
 $V_{IN} = 12\text{ V}$, $C_{SS} = 47\text{ nF}$, $R_L = \text{open}$, $C_L = 10\ \mu\text{F}$

TYPICAL WAVEFORMS

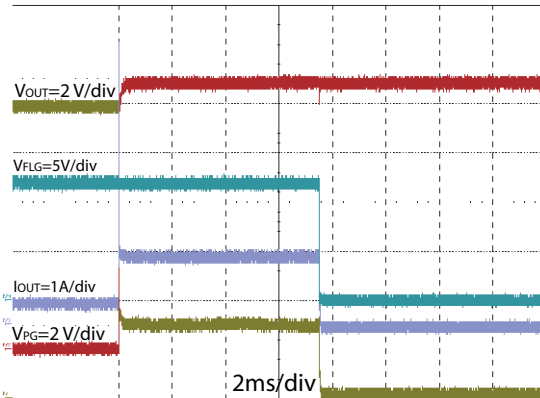


Fig. 28 - Current Limit
from 25 Ω to 2 Ω Load, $V_{IN} = 12\text{ V}$

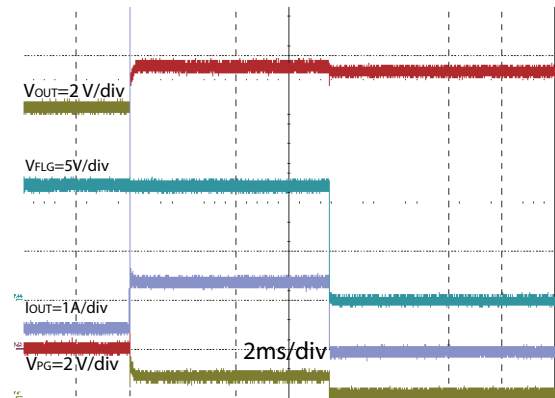


Fig. 30 - Current Limit
from 25 Ω to 0.5 Ω Load, $V_{IN} = 12\text{ V}$

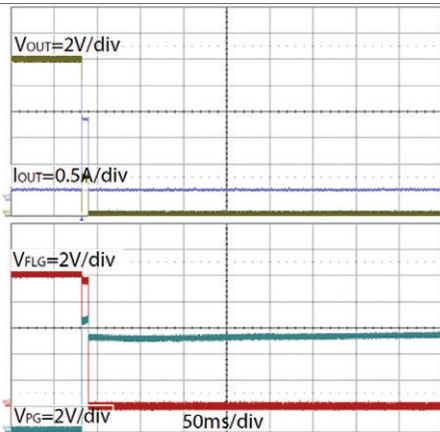


Fig. 29 - SiP32419
Remains OFF after seeing Fault Condition

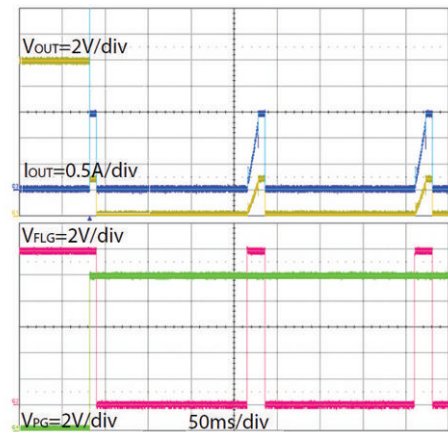


Fig. 31 - SiP32429
Re-Starts after ~ 150 ms during Fault Condition

DETAILED DESCRIPTION

Over Current Limit

The SiP32419 and SiP32429 current limit control circuit responds within 1 μ s (typ.) when an over current event occurs. During this brief period before the over current protection circuit is engaged, the parts will see a surge current especially under a severe output short condition. The magnitude of the surge current developed during the period when the overcurrent protection is not engaged is determined by impedance in the loop from the input current source to ground and the response time. This impedance is the sum total of the current source impedance, the path resistance and inductance and the load impedance. It is recommended to design the circuit to keep the peak current under 50 A by ensuring that there is sufficient impedance in the path to limit current to this recommended maximum of 50 A. Once the current limit circuit is engaged, the SiP32419 / SiP32429 will limit the current to the programmed set point. If the over current event exceeds 7 ms, the switch is turned off and the FLG pin is pulled low.

The SiP32429 features auto retry logic design and as long as enable is high, the part will restart after a 150 ms time out. The SiP32419 will remain off and can be reset by toggling V_{IN} or EN.

The current limit is set by connecting a resistor between the I_{LIM} pin and GND. R_{SET} can be calculated by the following formula:

$$I_{LIM} = \frac{1.24 \text{ V}}{R_{SET}} \times 5000$$

Where:

I_{LIM} = is the target current limit setting.

R_{SET} SELECTION TABLE				
R_{SET} (k Ω)	CURRENT LIMIT (A)			TOL. (%)
	MIN.	TYP.	MAX.	
1.74	2.85	3.56	4.28	20
1.78	2.78	3.48	4.18	20
1.82	2.73	3.41	4.09	20
2.21	2.25	2.81	3.37	20
2.80	1.77	2.21	2.66	20
3.57	1.39	1.74	2.08	20
4.12	1.20	1.50	1.81	20
4.53	1.03	1.37	1.71	25
5.76	0.81	1.08	1.35	25
7.32	0.64	0.85	1.06	25
8.25	0.56	0.75	0.94	25

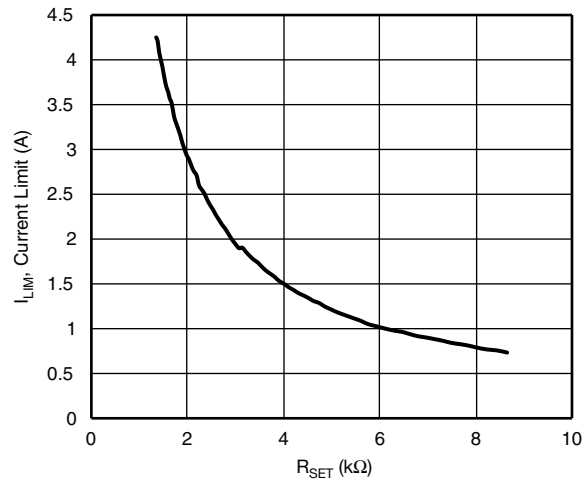


Fig. 32 - Current Limit vs. R_{SET}

Soft Start

The soft start time can be calculated by the following formula:

$$\frac{\Delta V_{OUT}}{\Delta t} = \frac{I_{SS}}{C_{SS}} \times \frac{R_{OUT} \times 5000}{R_{SET}}$$

Where:

Δt is the soft start time

ΔV_{OUT} is the output voltage range

I_{SS} is the built-in current source charging the soft start capacitor C_{SS} . I_{SS} value is 5 μ A typical.

C_{SS} is the soft start time setting capacitor.

R_{SET} is the current limit setting resistor.

R_{OUT} is the output load.

Enable

The enable pin needs to be high for the device to become active. This can be accomplished by applying a logic high signal to the EN pin. Alternatively this pin can be hardwired through a resistor divider to the V_{IN} , thus keeping the switch permanently on as long as the supply is present.

FLG

The \overline{FLG} is an open drain output and will be pulled low in fault condition. This pin can be pulled up through a 100K resistor.

PG

The \overline{PG} is an open drain output that will be pulled low when output voltage passes 90 % of the V_{IN} . This pin can be pulled up through a 100K resistor.

APPLICATION INFORMATION

Input Capacitor

While bypass capacitors at the inputs pins are not required, a 2.2 μ F or larger capacitors for C_{IN} is recommended in almost all applications. The bypass capacitors should be placed as physically close to the device’s input pins to be effective to minimize transients on the input. Ceramic capacitors are recommended over tantalum because of their ability to withstand input current surges from low impedance sources such as batteries.

Output Capacitor

The device does not require an output capacitor for proper operation. A proper value C_{OUT} is recommended to accommodate load transient per circuit design requirements. There are no ESR or capacitor type requirements.

Over Temperature Shutdown

In case an over temperature event happens, the SiP32419 and SiP32429 will turn the switch off immediately. The SiP32429 will then retry to start 150 ms after the temperature is back to normal; during this period, \overline{FLG} will be pulled low. The SiP32419 \overline{FLG} will be pulled high 150 ms after the OT event has finished. The SiP32419 will remain off and not retry to start, \overline{FLG} will remain to be pulled low.

Thermal Consideration

SiP32419 and SiP23429 are designed to maintain a constant output load current. Due to physical limitations of the layout and assembly of the device the maximum switch current should be kept at reasonably safe level. However, another limiting characteristic of the safe operating load current is the thermal power dissipation.

SOA

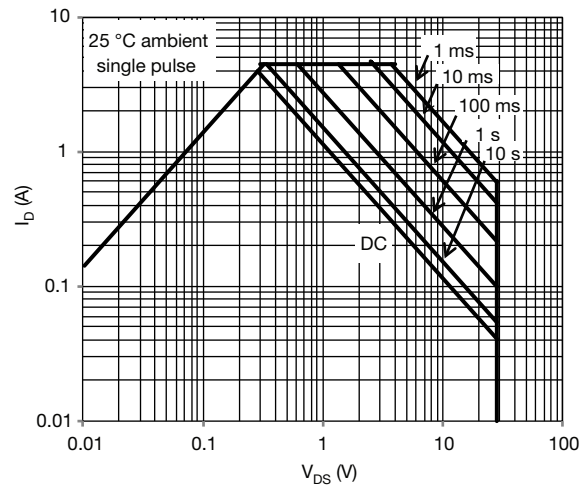


Fig. 33 - SOA on Application Board

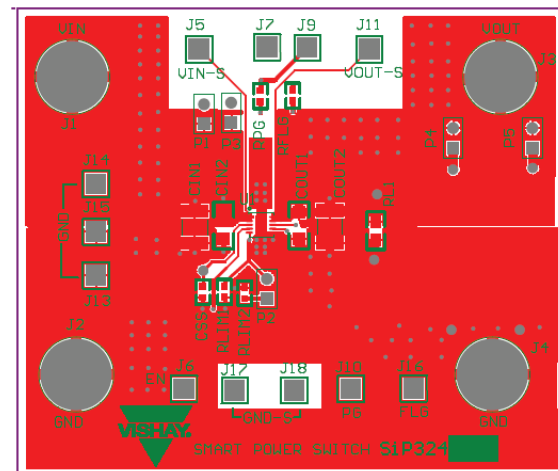


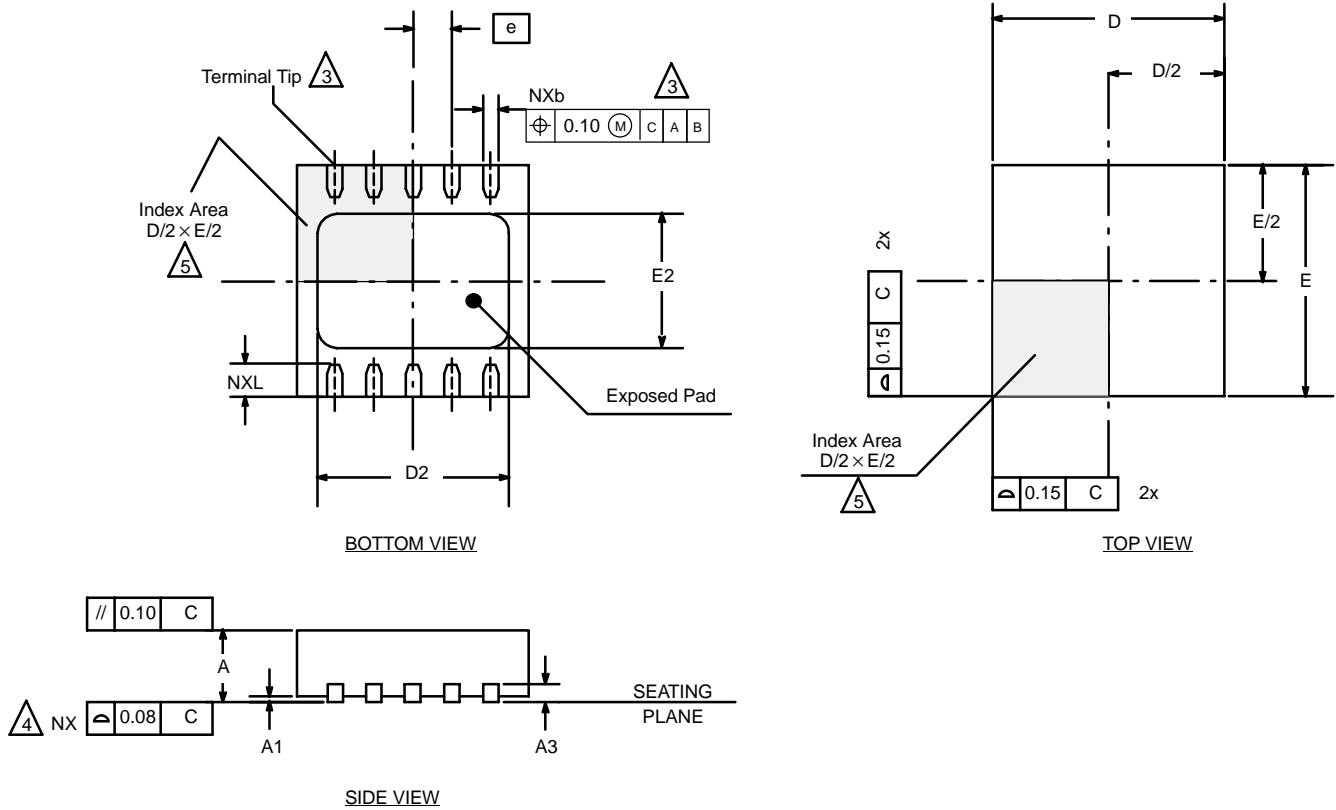
Fig. 34 - Application Board Layout



PRODUCT SUMMARY		
Part number	SiP32419	SiP32429
Description	6 V to 28 V, 56 mΩ, programmable current limit and slew rate, latch-off on fault	6 V to 28 V, 56 mΩ, programmable current limit and slew rate, auto-retry on fault
Configuration	Single	Single
Slew rate time (μs)	Adjustable	Adjustable
On delay time (μs)	550	550
Input voltage min. (V)	6	6
Input voltage max. (V)	28	28
On-resistance at input voltage min. (mΩ)	56	56
On-resistance at input voltage max. (mΩ)	56	56
Quiescent current at input voltage min. (μA)	139	139
Quiescent current at input voltage max. (μA)	172	172
Output discharge (yes / no)	No	No
Reverse blocking (yes / no)	No	No
Continuous current (A)	4.5	4.5
Current limit min. (A)	0.75	0.75
Current limit max. (A)	3.5	3.5
Absolute maximum input voltage (V)	30	30
Package type	DFN33-10L	DFN33-10L
Package size (W, L, H) (mm)	3.0 x 3.0 x 0.9	3.0 x 3.0 x 0.9
Status code	2	2
Product type	Slew rate, current limit	Slew rate, current limit
Applications	Computers, consumer, industrial, healthcare, networking, portable	Computers, consumer, industrial, healthcare, networking, portable

Vishay Siliconix maintains worldwide manufacturing capability. Products may be manufactured at one of several qualified locations. Reliability data for Silicon Technology and Package Reliability represent a composite of all qualified locations. For related documents such as package / tape drawings, part marking, and reliability data, see www.vishay.com/ppg?63939.

DFN-10 LEAD (3 X 3)



NOTES:

1. All dimensions are in millimeters and inches.

2. N is the total number of terminals.

3. Dimension b applies to metallized terminal and is measured between 0.15 and 0.30 mm from terminal tip.

4. Coplanarity applies to the exposed heat sink slug as well as the terminal.

5. The pin #1 identifier may be either a mold or marked feature, it must be located within the zone indicated.

Dim	MILLIMETERS			INCHES		
	Min	Nom	Max	Min	Nom	Max
A	0.80	0.90	1.00	0.031	0.035	0.039
A1	0.00	0.02	0.05	0.000	0.001	0.002
A3	0.20 BSC			0.008 BSC		
b	0.18	0.23	0.30	0.007	0.009	0.012
D	3.00 BSC			0.118 BSC		
D2	2.20	2.38	2.48	0.087	0.094	0.098
E	3.00 BSC			0.118 BSC		
E2	1.49	1.64	1.74	0.059	0.065	0.069
e	0.50 BSC			0.020 BSC		
L	0.30	0.40	0.50	0.012	0.016	0.020
*Use millimeters as the primary measurement.						
ECN: S-42134—Rev. A, 29-Nov-04						
DWG: 5943						



Disclaimer

ALL PRODUCT, PRODUCT SPECIFICATIONS AND DATA ARE SUBJECT TO CHANGE WITHOUT NOTICE TO IMPROVE RELIABILITY, FUNCTION OR DESIGN OR OTHERWISE.

Vishay Intertechnology, Inc., its affiliates, agents, and employees, and all persons acting on its or their behalf (collectively, "Vishay"), disclaim any and all liability for any errors, inaccuracies or incompleteness contained in any datasheet or in any other disclosure relating to any product.

Vishay makes no warranty, representation or guarantee regarding the suitability of the products for any particular purpose or the continuing production of any product. To the maximum extent permitted by applicable law, Vishay disclaims (i) any and all liability arising out of the application or use of any product, (ii) any and all liability, including without limitation special, consequential or incidental damages, and (iii) any and all implied warranties, including warranties of fitness for particular purpose, non-infringement and merchantability.

Statements regarding the suitability of products for certain types of applications are based on Vishay's knowledge of typical requirements that are often placed on Vishay products in generic applications. Such statements are not binding statements about the suitability of products for a particular application. It is the customer's responsibility to validate that a particular product with the properties described in the product specification is suitable for use in a particular application. Parameters provided in datasheets and / or specifications may vary in different applications and performance may vary over time. All operating parameters, including typical parameters, must be validated for each customer application by the customer's technical experts. Product specifications do not expand or otherwise modify Vishay's terms and conditions of purchase, including but not limited to the warranty expressed therein.

Hyperlinks included in this datasheet may direct users to third-party websites. These links are provided as a convenience and for informational purposes only. Inclusion of these hyperlinks does not constitute an endorsement or an approval by Vishay of any of the products, services or opinions of the corporation, organization or individual associated with the third-party website. Vishay disclaims any and all liability and bears no responsibility for the accuracy, legality or content of the third-party website or for that of subsequent links.

Except as expressly indicated in writing, Vishay products are not designed for use in medical, life-saving, or life-sustaining applications or for any other application in which the failure of the Vishay product could result in personal injury or death. Customers using or selling Vishay products not expressly indicated for use in such applications do so at their own risk. Please contact authorized Vishay personnel to obtain written terms and conditions regarding products designed for such applications.

No license, express or implied, by estoppel or otherwise, to any intellectual property rights is granted by this document or by any conduct of Vishay. Product names and markings noted herein may be trademarks of their respective owners.

单击下面可查看定价，库存，交付和生命周期等信息

[>>Vishay\(威世\)](#)