

MBR1035 THRU MBR1060

SCHOTTKY RECTIFIER

Reverse Voltage - 35 to 60 Volts Forward Current - 10.0 Amperes

TO-220AC

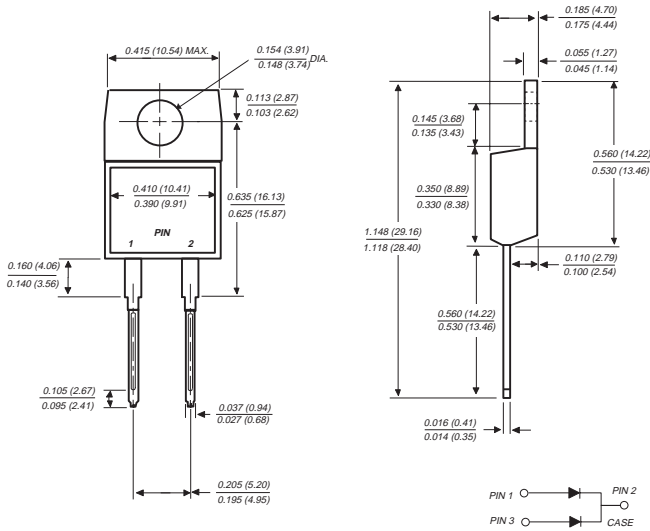

Dimensions in inches and (millimeters)

FEATURES

- ◆ Plastic package has Underwriters Laboratory Flammability Classifications 94V-0
- ◆ Metal silicon junction, majority carrier conduction
- ◆ Low power loss, high efficiency
- ◆ High current capability, low forward voltage drop
- ◆ High surge capability
- ◆ For use in low voltage, high frequency inverters, free wheeling, and polarity protection applications
- ◆ Guardring for overvoltage protection
- ◆ High temperature soldering guaranteed: 250°C/10 seconds, 0.25" (6.35mm) from case



MECHANICAL DATA

Case: JEDEC TO-220AC molded plastic body
Terminals: Leads solderable per MIL-STD-750, Method 2026
Polarity: As marked
Mounting Position: Any
Mounting Torque: 5 in. - lbs. max.
Weight: 0.08 ounces, 1.81 grams

MAXIMUM RATINGS AND ELECTRICAL CHARACTERISTICS

Ratings at 25°C ambient temperature unless otherwise specified.

	SYMBOLS	MBR1035	MBR1045	MBR1050	MBR1060	UNITS
Maximum repetitive peak reverse voltage	V _{RRM}	35	45	50	60	Volts
Maximum working peak reverse voltage	V _{RWM}	35	45	50	60	Volts
Maximum DC blocking voltage	V _{DC}	35	45	50	60	Volts
Maximum average forward rectified current (SEE FIG. 1)	I _(AV)	10.0				Amps
Peak repetitive forward current at T _C =135°C (square wave 20 KHz)	I _{FRM}	20.0				Amps
Peak forward surge current 8.3ms single half sine-wave superimposed on rated load (JEDEC Method)	I _{FSM}	150.0				Amps
Peak repetitive reverse surge current (NOTE 1)	I _{RRM}	1.0		0.5		Amps
Voltage rate of change (rated V _R)	dv/dt	10,000				V/μs
Maximum instantaneous forward voltage at (NOTE 2) I _F =10A, T _C =25°C I _F =10A, T _C =125°C I _F =20A, T _C =25°C I _F =20A, T _C =125°C	V _F	- 0.57 0.84 0.72		0.80 0.70 0.95 0.85		Volts
Maximum instantaneous reverse current at rated DC blocking voltage T _C = 25°C (NOTE 2) T _C =125°C	I _R		0.10 15.0			mA
Maximum thermal resistance, junction to case	R _{θJC}	2.0				°C/W
Operating junction temperature range	T _J	-65 to +150				°C
Storage temperature range	T _{STG}	-65 to +175				°C

NOTES:

- (1) 2.0μs pulse width, f=1.0 KHz
- (2) Pulse test: 300μs pulse width, 1% duty cycle



RATINGS AND CHARACTERISTIC CURVES MBR1035 THRU MBR1060

FIG. 1 - FORWARD CURRENT DERATING CURVE

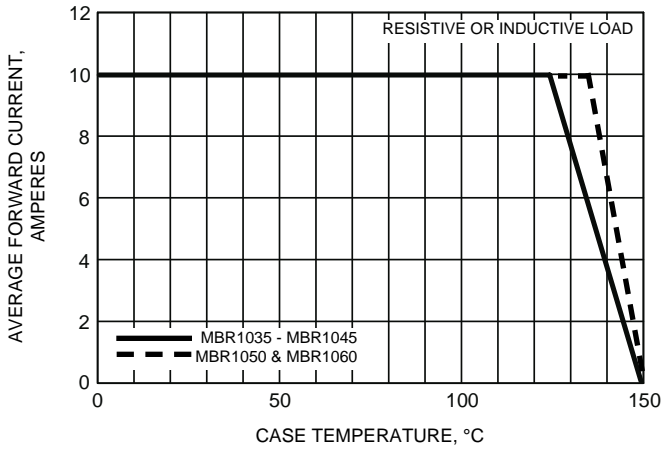

FIG. 2 - MAXIMUM NON-REPETITIVE PEAK FORWARD SURGE CURRENT

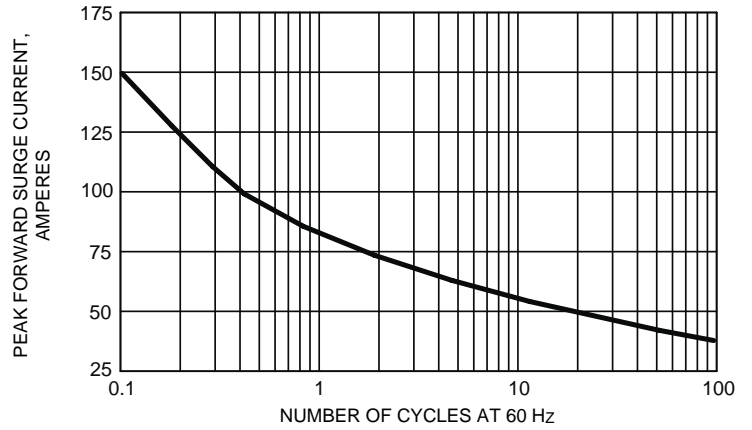

FIG. 3 - TYPICAL INSTANTANEOUS FORWARD CHARACTERISTICS

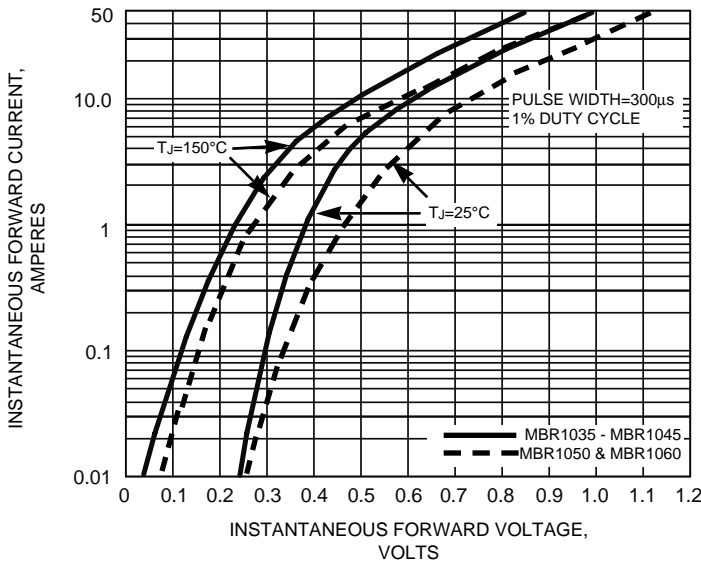

FIG. 4 - TYPICAL REVERSE CHARACTERISTICS

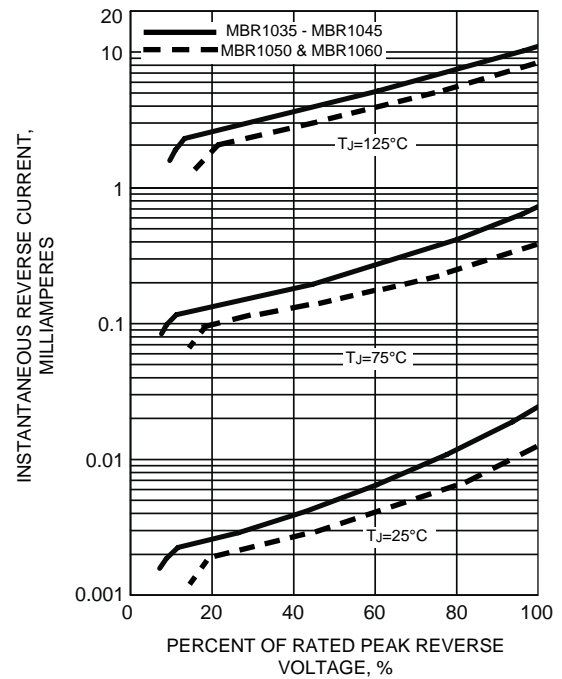

FIG. 5 - TYPICAL JUNCTION CAPACITANCE

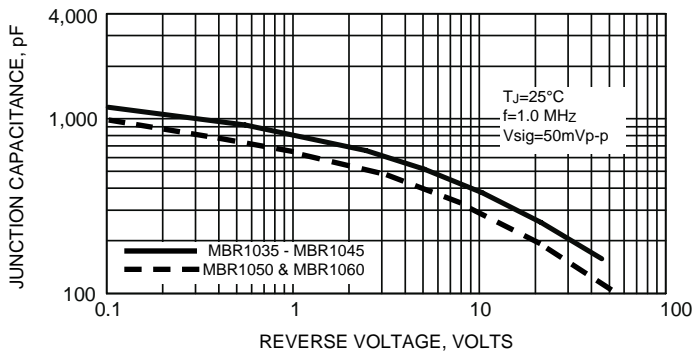
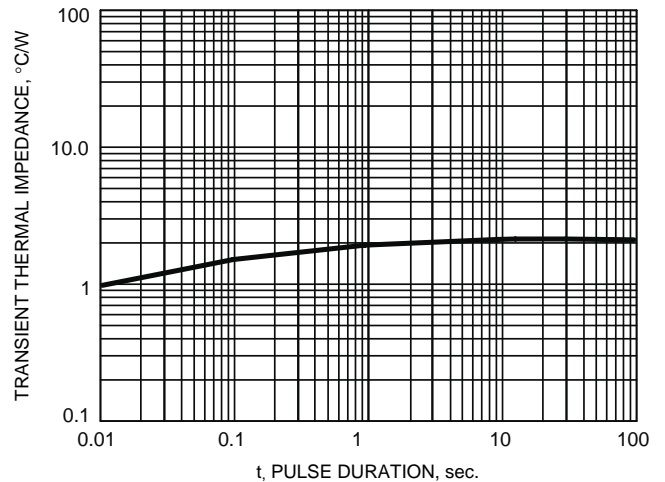

FIG. 6 - TYPICAL TRANSIENT THERMAL IMPEDANCE



单击下面可查看定价，库存，交付和生命周期等信息

[>>Vishay\(威世\)](#)