

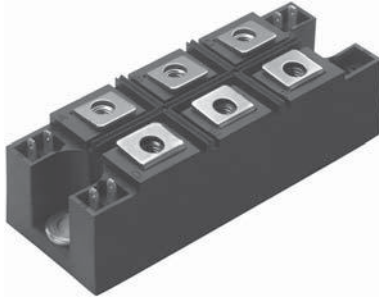

Three Phase AC Switch (Power Modules), 50 A to 100 A



MTK

PRODUCT SUMMARY	
I_O	50 A to 100 A
V_{RRM}	800 V to 1600 V
Package	MT-K
Circuit	Three phase AC switch

FEATURES

- Package fully compatible with the industry standard INT-A-PAK power modules series
- High thermal conductivity package, electrically insulated case
- Outstanding number of power encapsulated components
- Excellent power volume ratio
- 4000 V_{RMS} isolating voltage
- UL E78996 approved 
- Designed and qualified for industrial level
- Material categorization: For definitions of compliance please see www.vishay.com/doc?99912

RoHS
COMPLIANT

DESCRIPTION

A range of extremely compact, encapsulated three phase AC switches offering efficient and reliable operation. They are intended for use in general purpose and heavy duty applications as control motor starter.

MAJOR RATINGS AND CHARACTERISTICS					
SYMBOL	CHARACTERISTICS	54MT.K	94MT.K	104MT.K	UNITS
I_O		50	90	100	A
	T_C	80	80	80	°C
I_{FSM}	50 Hz	390	950	1130	A
	60 Hz	410	1000	1180	
I^2t	50 Hz	770	4525	6380	A ² s
	60 Hz	700	4130	5830	
$I^2\sqrt{t}$		7700	45250	63800	A ² √s
V_{RRM}	Range	800 to 1600			V
T_{Stg}	Range	-40 to 125			°C
T_J	Range	-40 to 125			°C



ELECTRICAL SPECIFICATIONS

VOLTAGE RATINGS					
TYPE NUMBER	VOLTAGE CODE	V _{RRM} , MAXIMUM REPETITIVE PEAK REVERSE VOLTAGE V	V _{RSM} , MAXIMUM NON-REPETITIVE PEAK REVERSE VOLTAGE V	V _{DRM} , MAXIMUM REPETITIVE PEAK OFF-STATE VOLTAGE, GATE OPEN CIRCUIT V	I _{RRM} /I _{DRM} , MAXIMUM AT T _J = 125 °C mA
54MT..K	80	800	900	800	20 ⁽¹⁾
	100	1000	1100	1000	
	120	1200	1300	1200	
	140	1400	1500	1400	
	160	1600	1700	1600	
94/104MT..K	80	800	900	800	40 ⁽¹⁾
	100	1000	1100	1000	
	120	1200	1300	1200	
	140	1400	1500	1400	
	160	1600	1700	1600	

Note

⁽¹⁾ For single AC switch

FORWARD CONDUCTION								
PARAMETER	SYMBOL	TEST CONDITIONS		54MT.K	94MT.K	104MT.K	UNITS	
Maximum I _{RMS} output current at case temperature	I _O	For all conduction angle		50	90	100	A	
				80	80	80	°C	
Maximum peak, one-cycle forward, non-repetitive on state surge current	I _{TSM}	t = 10 ms	No voltage reapplied	Initial T _J = T _J maximum	390	950	1130	A
		t = 8.3 ms			410	1000	1180	
		t = 10 ms	100 % V _{RRM} reapplied		330	800	950	
		t = 8.3 ms			345	840	1000	
Maximum I ² t for fusing	I ² t	t = 10 ms	No voltage reapplied		770	4525	6380	A ² s
		t = 8.3 ms			700	4130	5830	
		t = 10 ms	100 % V _{RRM} reapplied		540	3200	4510	
		t = 8.3 ms			500	2920	4120	
Maximum I ² √t for fusing	I ² √t	t = 0.1 to 10 ms, no voltage reapplied		7700	45 250	63 800	A ² √s	
Low level value of threshold voltage	V _{T(TO)1}	(16.7 % × π × I _{T(AV)} < I < π × I _{T(AV)}), T _J maximum		1.16	0.99	0.99	V	
High level value of threshold voltage	V _{T(TO)2}	(I > π × I _{T(AV)}), T _J maximum		1.44	1.19	1.15		
Low level value on-state slope resistance	r _{t1}	16.7 % × π × I _{T(AV)} < I < π × I _{T(AV)} , T _J maximum		12.54	4.16	3.90	mΩ	
High level value on-state slope resistance	r _{t2}	(I > π × I _{T(AV)}), T _J maximum		11.00	3.56	3.48		
Maximum on-state voltage drop	V _{TM}	I _{pk} = 150 A, T _J = 25 °C t _p = 400 μs single junction		2.68	1.55	1.53	V	
Maximum non-repetitive rate of rise of turned on current	di/dt	T _J = 25 °C, from 0.67 V _{DRM} , I _{TM} = π × I _{T(AV)} , I _g = 500 mA, t _r < 0.5 μs, t _p > 6 μs		150			A/μs	
Maximum holding current	I _H	T _J = 25 °C, anode supply = 6 V, resistive load, grate open circuit		200			mA	
Maximum latching current	I _L	T _J = 25 °C, anode supply = 6 V, resistive load		400				



BLOCKING						
PARAMETER	SYMBOL	TEST CONDITIONS	54MT.K	94MT.K	104MT.K	UNITS
RMS isolation voltage	V_{INS}	$T_J = 25\text{ }^\circ\text{C}$ all terminal shorted $f = 50\text{ Hz}$, $t = 1\text{ s}$	4000			V
Maximum critical rate of rise of off-state voltage	$dV/dt^{(1)}$	$T_J = T_J$ maximum, linear to $0.67 V_{DRM}$, gate open circuit	500			V/ μs

Note

(1) Available with $dV/dt = 1000\text{ V}/\mu\text{s}$, to complete code add S90 i. e. 104MT160KBS90

TRIGGERING						
PARAMETER	SYMBOL	TEST CONDITIONS	54MT.K	94MT.K	104MT.K	UNITS
Maximum peak gate power	P_{GM}	$T_J = T_J$ maximum	10			W
Maximum average gate power	$P_{G(AV)}$		2.5			
Maximum peak gate current	I_{GM}		2.5			A
Maximum peak negative gate voltage	$-V_{GT}$		10			V
Maximum required DC gate voltage to trigger	V_{GT}	$T_J = 40\text{ }^\circ\text{C}$	4.0			
		$T_J = 25\text{ }^\circ\text{C}$	2.5			
		$T_J = 125\text{ }^\circ\text{C}$	1.7			
Maximum required DC gate current to trigger	I_{GT}	$T_J = -40\text{ }^\circ\text{C}$	270			mA
		$T_J = 25\text{ }^\circ\text{C}$	150			
		$T_J = 125\text{ }^\circ\text{C}$	80			
Maximum gate voltage that will not trigger	V_{GD}	$T_J = T_J$ maximum, rated V_{DRM} applied	0.25			V
Maximum gate current that will not trigger	I_{GD}		6			mA

THERMAL AND MECHANICAL SPECIFICATIONS						
PARAMETER	SYMBOL	TEST CONDITIONS	54MT.K	94MT.K	104MT.K	UNITS
Maximum junction operating and storage temperature range	T_J, T_{Stg}		-40 to 125			$^\circ\text{C}$
Maximum thermal resistance, junction to case	R_{thJC}	DC operation per single AC switch	0.52	0.39	0.34	K/W
		DC operation per junction	1.05	0.77	0.69	
		180 $^\circ\text{C}$ sine cond. angle per single AC switch	0.56	0.40	0.36	
		180 $^\circ\text{C}$ sine cond. angle per junction	1.12	0.80	0.72	
Maximum thermal resistance, case to heatsink	R_{thCS}	Per module Mounting surface smooth, flat and grased	0.03			
Mounting torque $\pm 100\%$	to heatsink to terminal	A mounting compound is recommended and the torque should be rechecked after a period of 3 hours to allow for the spread of the compound. Lubricated threads.	4 to 6			Nm
			3 to 4			
Approximate weight			225			g

ΔR CONDUCTION PER JUNCTION											
DEVICES	SINUSOIDAL CONDUCTION AT T_J MAXIMUM					RECTANGULAR CONDUCTION AT T_J MAXIMUM					UNITS
	180 $^\circ$	120 $^\circ$	90 $^\circ$	60 $^\circ$	30 $^\circ$	180 $^\circ$	120 $^\circ$	90 $^\circ$	60 $^\circ$	30 $^\circ$	
54MT.K	0.072	0.085	0.108	0.152	0.233	0.055	0.091	0.117	0.157	0.236	K/W
94MT.K	0.033	0.039	0.051	0.069	0.099	0.027	0.044	0.055	0.071	0.100	
104MT.K	0.027	0.033	0.042	0.057	0.081	0.023	0.037	0.046	0.059	0.082	

Note

- Table shows the increment of thermal resistance R_{thJC} when devices operate at different conduction angles than DC

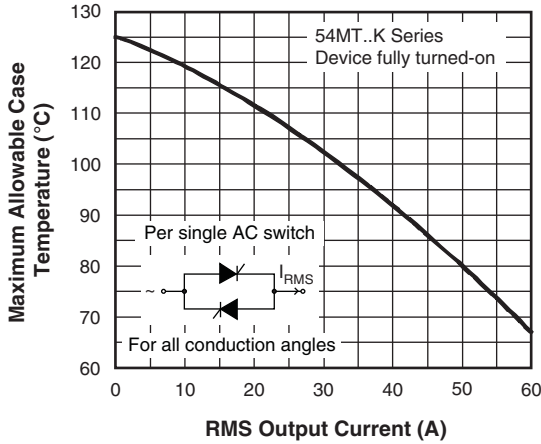

Fig. 1 - Current Ratings Characteristic

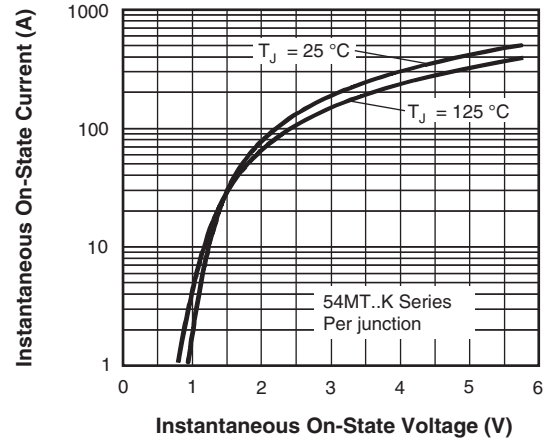

Fig. 2 - Forward Voltage Drop Characteristics

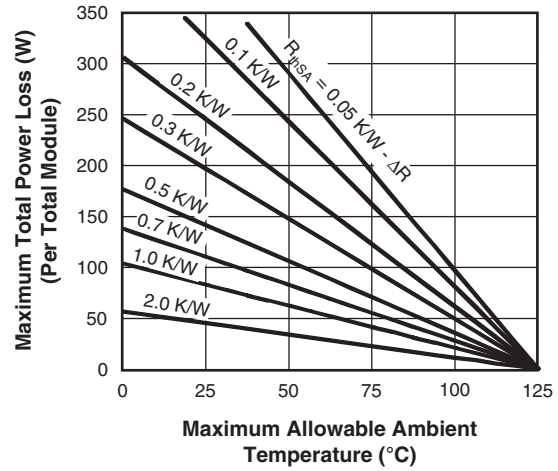
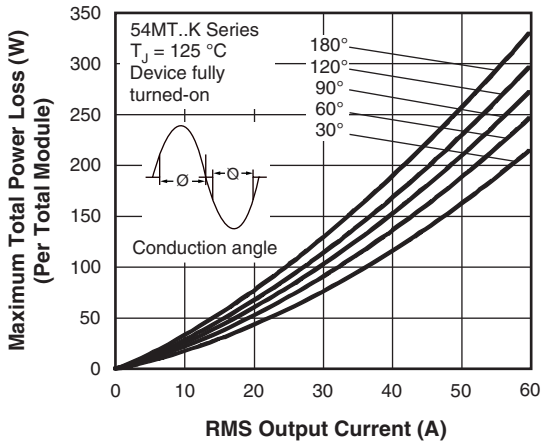

Fig. 3 - Total Power Loss Characteristics

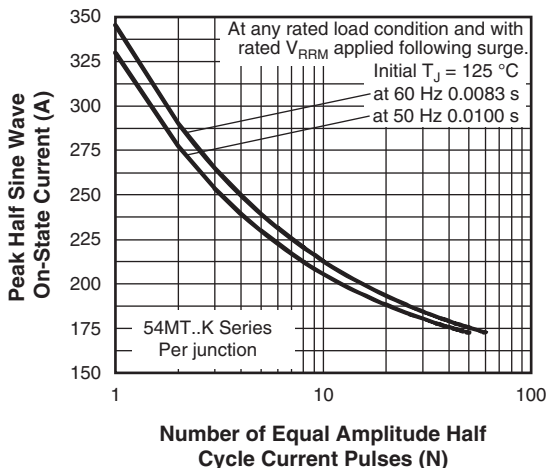

Fig. 4 - Maximum Non-Repetitive Surge Current

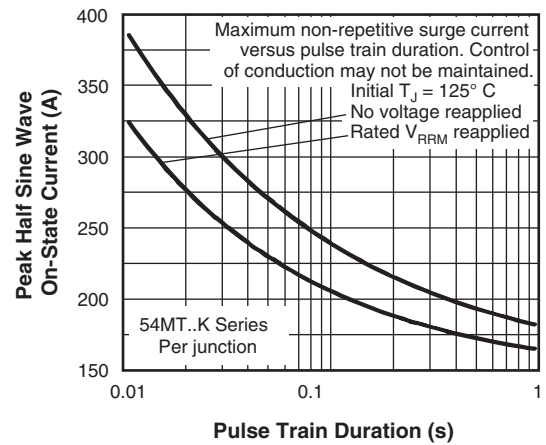

Fig. 5 - Maximum Non-Repetitive Surge Current

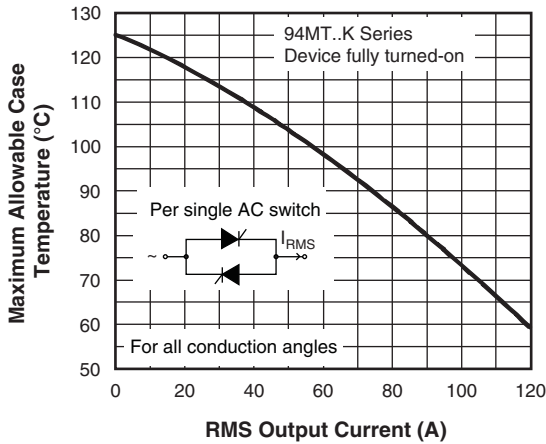

Fig. 6 - Current Ratings Characteristic

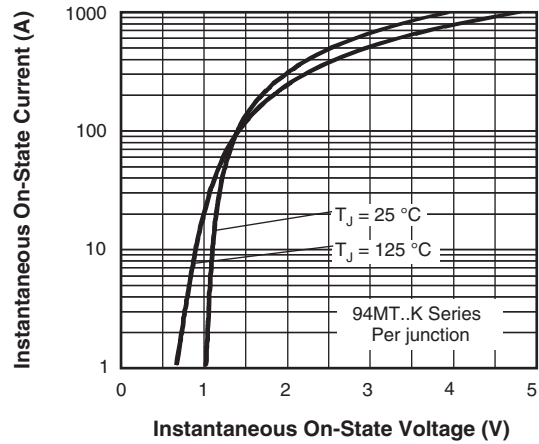

Fig. 7 - Forward Voltage Drop Characteristics

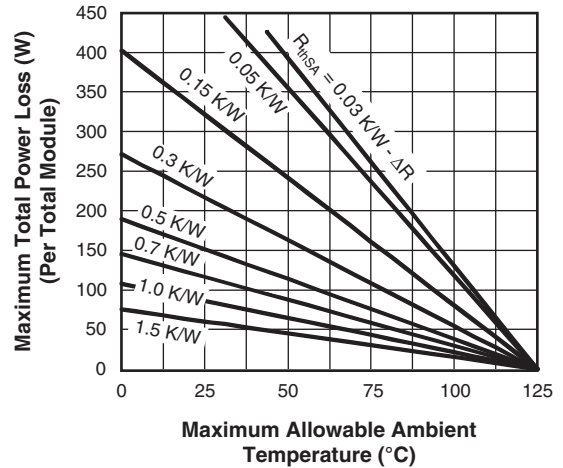
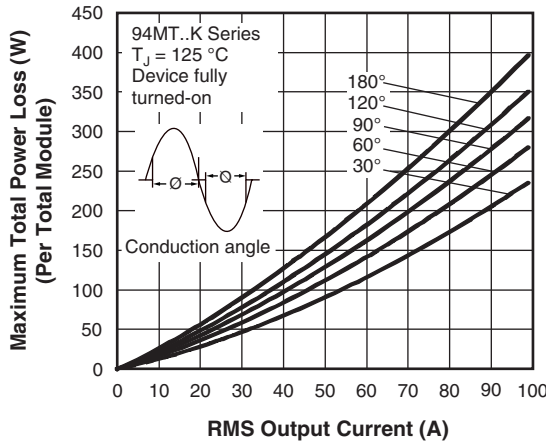

Fig. 8 - Total Power Loss Characteristics

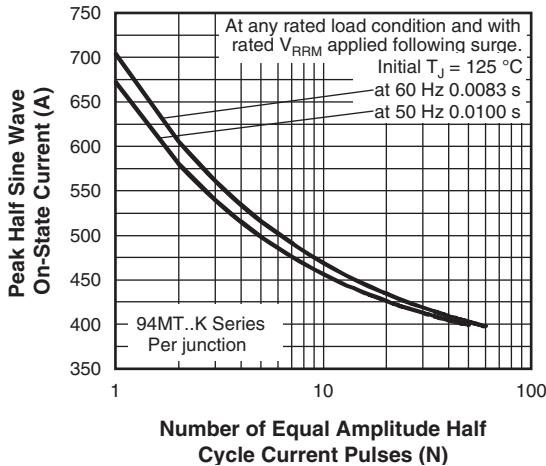

Fig. 9 - Maximum Non-Repetitive Surge Current

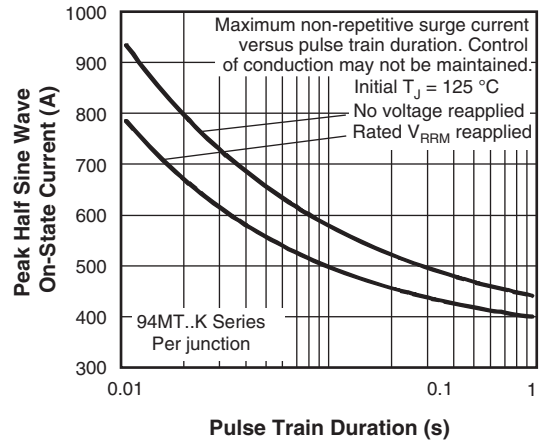

Fig. 10 - Maximum Non-Repetitive Surge Current

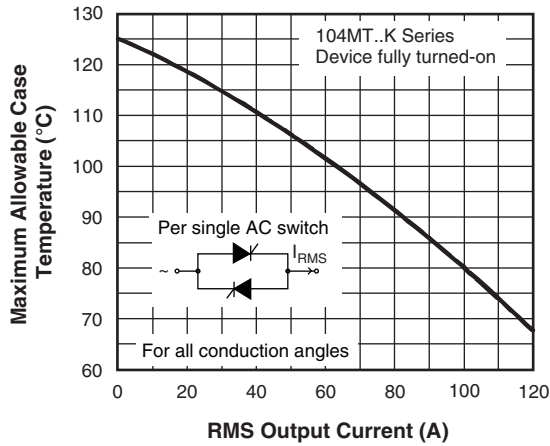

Fig. 11 - Current Ratings Characteristic

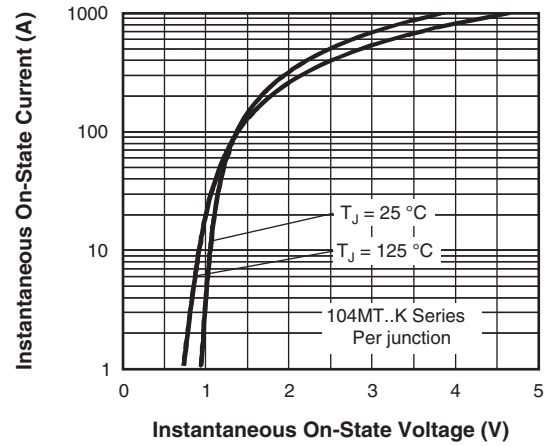

Fig. 12 - Forward Voltage Drop Characteristics

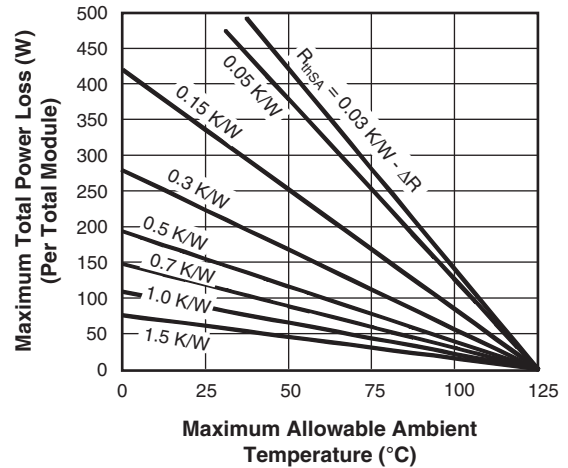
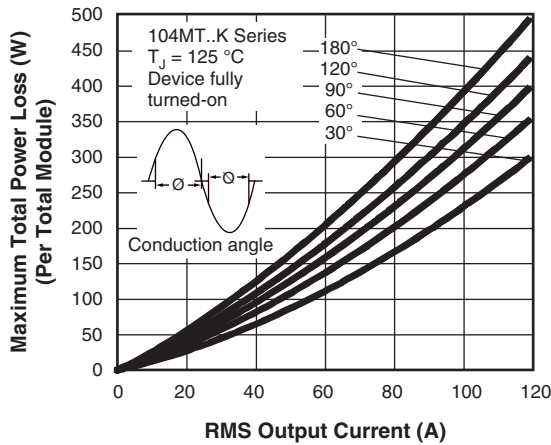

Fig. 13 - Total Power Loss Characteristics

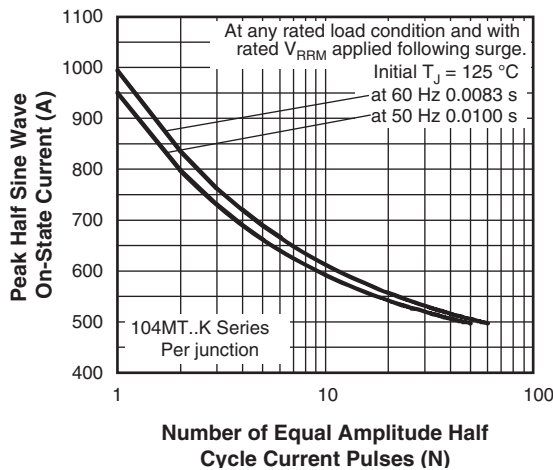

Fig. 14 - Maximum Non-Repetitive Surge Current

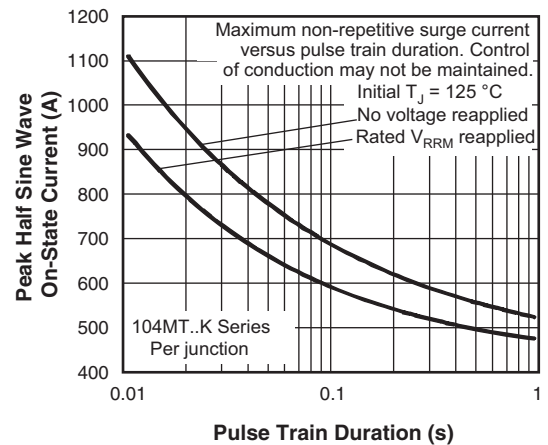

Fig. 15 - Maximum Non-Repetitive Surge Current

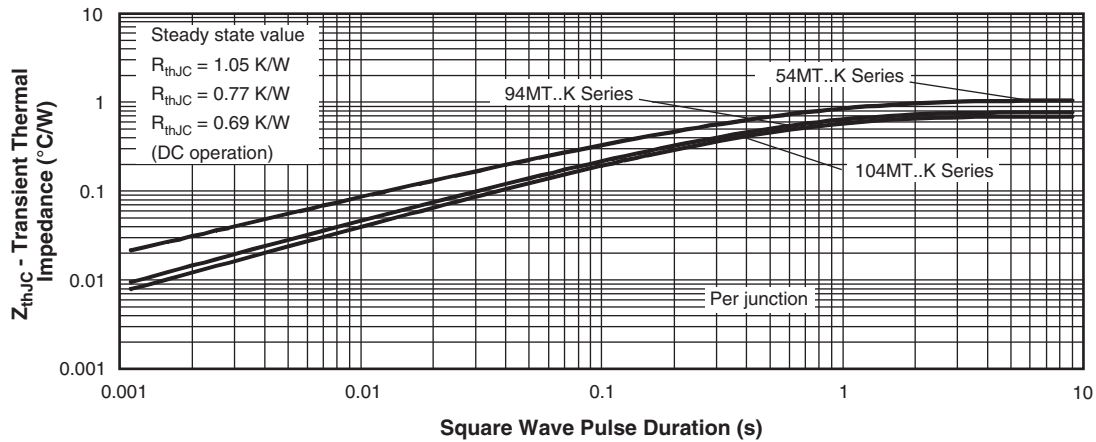

Fig. 16 - Thermal Impedance Z_{thJC} Characteristics

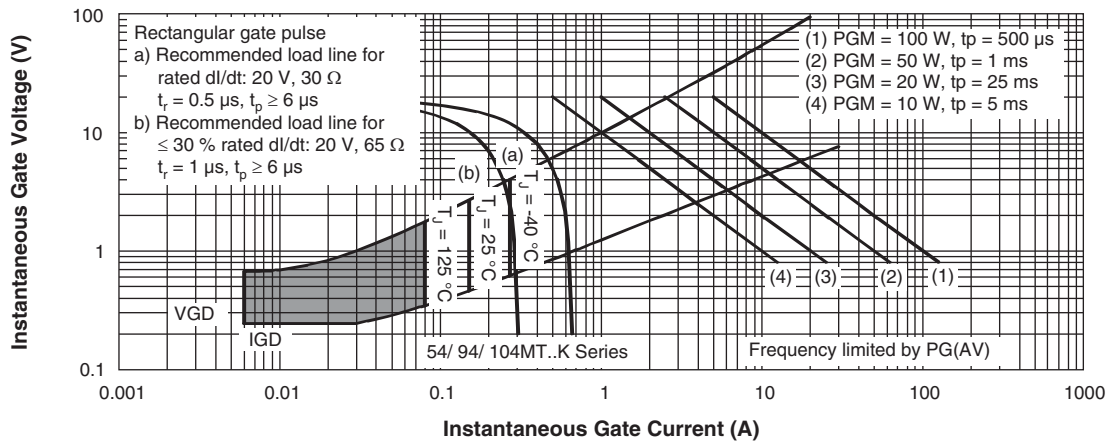

Fig. 17 - Gate Characteristics

ORDERING INFORMATION TABLE

Device code	10	4	MT	160	K	PbF
	(1)	(2)	(3)	(4)		(5)

- 1** - Current rating code: 5 = 50 A (average)
9 = 90 A (average)
10 = 100 A (average)
- 2** - AC switch
- 3** - Essential part number
- 4** - Voltage code x 10 = V_{RRM} (see Voltage Ratings table)
- 5** - PbF = Lead (Pb)-free

Note

- To order the optional hardware go to www.vishay.com/doc?95172



CIRCUIT CONFIGURATION

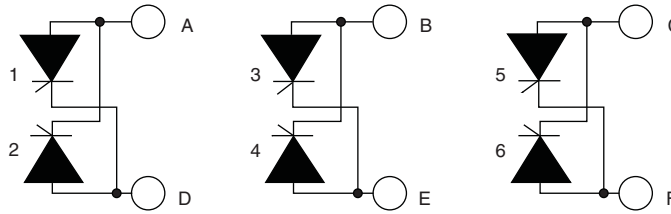

LINKS TO RELATED DOCUMENTS	
Dimensions	www.vishay.com/doc?95004

MTK (with and without optional barrier)

DIMENSIONS WITH OPTIONAL BARRIERS in millimeters (inches)

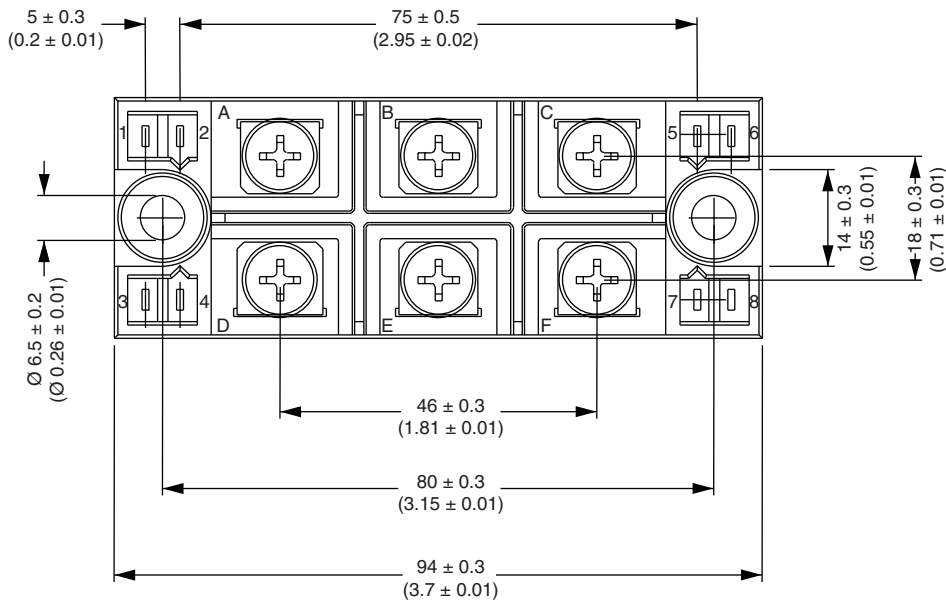
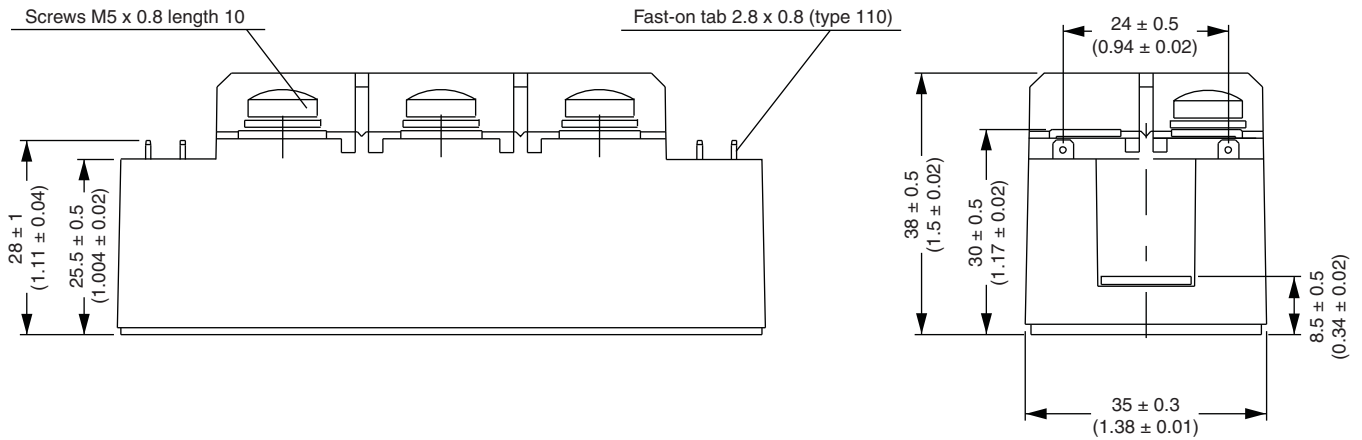

Outline Dimensions

Vishay Semiconductors MTK (with and without optional barrier)



DIMENSIONS WITHOUT OPTIONAL BARRIERS in millimeters (inches)

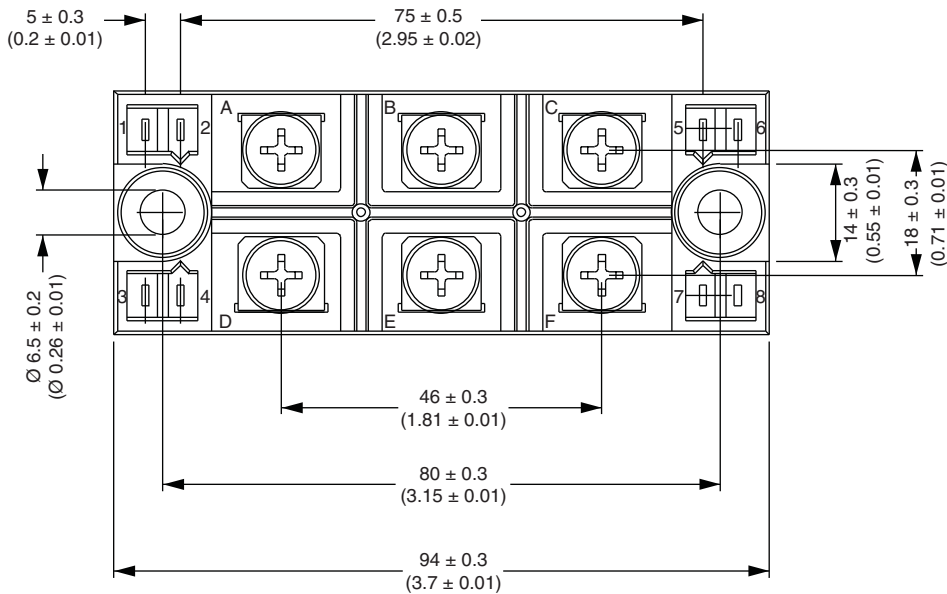
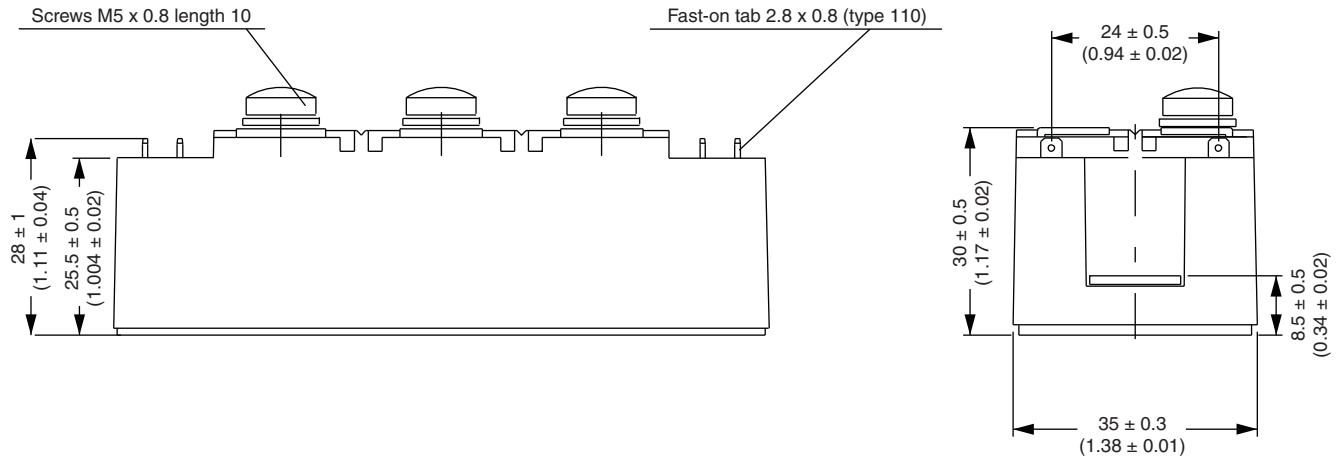



Disclaimer

ALL PRODUCT, PRODUCT SPECIFICATIONS AND DATA ARE SUBJECT TO CHANGE WITHOUT NOTICE TO IMPROVE RELIABILITY, FUNCTION OR DESIGN OR OTHERWISE.

Vishay Intertechnology, Inc., its affiliates, agents, and employees, and all persons acting on its or their behalf (collectively, "Vishay"), disclaim any and all liability for any errors, inaccuracies or incompleteness contained in any datasheet or in any other disclosure relating to any product.

Vishay makes no warranty, representation or guarantee regarding the suitability of the products for any particular purpose or the continuing production of any product. To the maximum extent permitted by applicable law, Vishay disclaims (i) any and all liability arising out of the application or use of any product, (ii) any and all liability, including without limitation special, consequential or incidental damages, and (iii) any and all implied warranties, including warranties of fitness for particular purpose, non-infringement and merchantability.

Statements regarding the suitability of products for certain types of applications are based on Vishay's knowledge of typical requirements that are often placed on Vishay products in generic applications. Such statements are not binding statements about the suitability of products for a particular application. It is the customer's responsibility to validate that a particular product with the properties described in the product specification is suitable for use in a particular application. Parameters provided in datasheets and/or specifications may vary in different applications and performance may vary over time. All operating parameters, including typical parameters, must be validated for each customer application by the customer's technical experts. Product specifications do not expand or otherwise modify Vishay's terms and conditions of purchase, including but not limited to the warranty expressed therein.

Except as expressly indicated in writing, Vishay products are not designed for use in medical, life-saving, or life-sustaining applications or for any other application in which the failure of the Vishay product could result in personal injury or death. Customers using or selling Vishay products not expressly indicated for use in such applications do so at their own risk. Please contact authorized Vishay personnel to obtain written terms and conditions regarding products designed for such applications.

No license, express or implied, by estoppel or otherwise, to any intellectual property rights is granted by this document or by any conduct of Vishay. Product names and markings noted herein may be trademarks of their respective owners.

Material Category Policy

Vishay Intertechnology, Inc. hereby certifies that all its products that are identified as RoHS-Compliant fulfill the definitions and restrictions defined under Directive 2011/65/EU of The European Parliament and of the Council of June 8, 2011 on the restriction of the use of certain hazardous substances in electrical and electronic equipment (EEE) - recast, unless otherwise specified as non-compliant.

Please note that some Vishay documentation may still make reference to RoHS Directive 2002/95/EC. We confirm that all the products identified as being compliant to Directive 2002/95/EC conform to Directive 2011/65/EU.

Vishay Intertechnology, Inc. hereby certifies that all its products that are identified as Halogen-Free follow Halogen-Free requirements as per JEDEC JS709A standards. Please note that some Vishay documentation may still make reference to the IEC 61249-2-21 definition. We confirm that all the products identified as being compliant to IEC 61249-2-21 conform to JEDEC JS709A standards.

单击下面可查看定价，库存，交付和生命周期等信息

[>>Vishay\(威世\)](#)