

## Complementary N- and P-Channel 20 V (D-S) MOSFET

PRODUCT SUMMARY			
	$V_{DS}$ (V)	$R_{DS(on)}$ ( $\Omega$ )	$I_D$ (mA)
N-Channel	20	0.70 at $V_{GS} = 4.5$ V	600
		0.85 at $V_{GS} = 2.5$ V	500
		1.25 at $V_{GS} = 1.8$ V	350
P-Channel	- 20	1.2 at $V_{GS} = - 4.5$ V	- 400
		1.6 at $V_{GS} = - 2.5$ V	- 300
		2.7 at $V_{GS} = - 1.8$ V	- 150

### FEATURES

- Halogen-free According to IEC 61249-2-21 Definition
- TrenchFET<sup>®</sup> Power MOSFETs
- 2000 V ESD Protection
- Very Small Footprint
- High-Side Switching
- Low On-Resistance:  
N-Channel, 0.7  $\Omega$   
P-Channel, 1.2  $\Omega$
- Low Threshold:  $\pm 0.8$  V (Typ.)
- Fast Switching Speed: 14 ns
- 1.8 V Operation
- Compliant to RoHS Directive 2002/95/EC



**RoHS**  
COMPLIANT  
HALOGEN  
**FREE**

### BENEFITS

- Ease in Driving Switches
- Low Offset (Error) Voltage
- Low-Voltage Operation
- High-Speed Circuits
- Low Battery Voltage Operation

### APPLICATIONS

- Replace Digital Transistor, Level-Shifter
- Battery Operated Systems
- Power Supply Converter Circuits

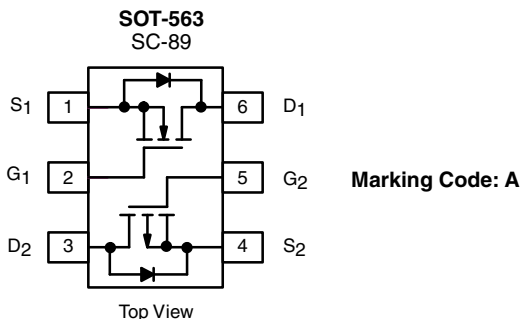

**Ordering Information:** Si1016X-T1-GE3 (Lead (Pb)-free and Halogen-free)

ABSOLUTE MAXIMUM RATINGS ( $T_A = 25$ °C, unless otherwise noted)							
Parameter	Symbol	N-Channel		P-Channel		Unit	
		5 s	Steady State	5 s	Steady State		
Drain-Source Voltage	$V_{DS}$	20		- 20		V	
Gate-Source Voltage	$V_{GS}$	$\pm 6$					
Continuous Drain Current ( $T_J = 150$ °C) <sup>a</sup>	$I_D$	$T_A = 25$ °C	515	485	- 390	- 370	mA
		$T_A = 85$ °C	370	350	- 280	- 265	
Pulsed Drain Current <sup>b</sup>	$I_{DM}$	650		- 650			
Continuous Source Current (Diode Conduction) <sup>a</sup>	$I_S$	450	380	- 450	- 380	mW	
Maximum Power Dissipation <sup>a</sup>	$P_D$	$T_A = 25$ °C	280	250	280		250
		$T_A = 85$ °C	145	130	145		130
Operating Junction and Storage Temperature Range	$T_J, T_{stg}$	- 55 to 150				°C	
Gate-Source ESD Rating (HBM, Method 3015)	ESD	2000				V	

Notes:

a. Surface mounted on FR4 board.

b. Pulse width limited by maximum junction temperature.

SPECIFICATIONS ( $T_J = 25\text{ }^\circ\text{C}$ , unless otherwise noted)							
Parameter	Symbol	Test Conditions	Min.	Typ.	Max.	Unit	
<b>Static</b>							
Gate Threshold Voltage	$V_{GS(th)}$	$V_{DS} = V_{GS}, I_D = 250\text{ }\mu\text{A}$	N-Ch	0.45		1	V
		$V_{DS} = V_{GS}, I_D = -250\text{ }\mu\text{A}$	P-Ch	-0.45		-1	
Gate Body Leakage	$I_{GSS}$	$V_{DS} = 0\text{ V}, V_{GS} = \pm 4.5\text{ V}$	N-Ch P-Ch		$\pm 0.5$ $\pm 1.0$	$\pm 1.0$ $\pm 2.0$	$\mu\text{A}$
Zero Gate Voltage Drain Current	$I_{DSS}$	$V_{DS} = 16\text{ V}, V_{GS} = 0\text{ V}$	N-Ch		0.3	100	nA
		$V_{DS} = -16\text{ V}, V_{GS} = 0\text{ V}$	P-Ch		-0.3	-100	
		$V_{DS} = 16\text{ V}, V_{GS} = 0\text{ V}, T_J = 85\text{ }^\circ\text{C}$	N-Ch			5	$\mu\text{A}$
		$V_{DS} = -16\text{ V}, V_{GS} = 0\text{ V}, T_J = 85\text{ }^\circ\text{C}$	P-Ch			-5	
On State Drain Current <sup>a</sup>	$I_{D(on)}$	$V_{DS} = 5\text{ V}, V_{GS} = 4.5\text{ V}$	N-Ch	700			mA
		$V_{DS} = -5\text{ V}, V_{GS} = -4.5\text{ V}$	P-Ch	-700			
Drain-Source On-State Resistance <sup>a</sup>	$R_{DS(on)}$	$V_{GS} = 4.5\text{ V}, I_D = 600\text{ mA}$	N-Ch		0.41	0.70	$\Omega$
		$V_{GS} = -4.5\text{ V}, I_D = -350\text{ mA}$	P-Ch		0.80	1.2	
		$V_{GS} = 2.5\text{ V}, I_D = 500\text{ mA}$	N-Ch		0.53	0.85	
		$V_{GS} = -2.5\text{ V}, I_D = -300\text{ mA}$	P-Ch		1.20	1.6	
		$V_{GS} = 1.8\text{ V}, I_D = 350\text{ mA}$	N-Ch		0.70	1.25	
		$V_{GS} = -1.8\text{ V}, I_D = -150\text{ mA}$	P-Ch		1.80	2.7	
Forward Transconductance <sup>a</sup>	$g_{fs}$	$V_{DS} = 10\text{ V}, I_D = 400\text{ mA}$	N-Ch		1.0		S
		$V_{DS} = -10\text{ V}, I_D = -250\text{ mA}$	P-Ch		0.4		
Diode Forward Voltage <sup>a</sup>	$V_{SD}$	$I_S = 150\text{ mA}, V_{GS} = 0\text{ V}$	N-Ch		0.8	1.2	V
		$I_S = -150\text{ mA}, V_{GS} = 0\text{ V}$	P-Ch		-0.8	-1.2	
<b>Dynamic<sup>b</sup></b>							
Total Gate Charge	$Q_g$	N-Channel $V_{DS} = 10\text{ V}, V_{GS} = 4.5\text{ V}, I_D = 250\text{ mA}$ P-Channel $V_{DS} = -10\text{ V}, V_{GS} = -4.5\text{ V}, I_D = -250\text{ mA}$	N-Ch		750		pC
Gate-Source Charge	$Q_{gs}$		N-Ch		75		
			P-Ch		150		
Gate-Drain Charge	$Q_{gd}$	N-Ch		225			
		P-Ch		450			
Turn-On Time	$t_{ON}$	N-Channel $V_{DD} = 10\text{ V}, R_L = 47\text{ }\Omega$ $I_D \cong 200\text{ mA}, V_{GEN} = 4.5\text{ V}, R_g = 10\text{ }\Omega$ P-Channel $V_{DD} = -10\text{ V}, R_L = 47\text{ }\Omega$ $I_D \cong -200\text{ mA}, V_{GEN} = -4.5\text{ V}, R_g = 10\text{ }\Omega$	N-Ch		5		ns
Turn-Off Time	$t_{OFF}$		N-Ch		25		
		P-Ch		35			

Notes:

a. Pulse test; pulse width  $\leq 300\text{ }\mu\text{s}$ , duty cycle  $\leq 2\%$ .

b. Guaranteed by design, not subject to production testing.

Stresses beyond those listed under "Absolute Maximum Ratings" may cause permanent damage to the device. These are stress ratings only, and functional operation of the device at these or any other conditions beyond those indicated in the operational sections of the specifications is not implied. Exposure to absolute maximum rating conditions for extended periods may affect device reliability.

**N-CHANNEL TYPICAL CHARACTERISTICS** ( $T_A = 25\text{ }^\circ\text{C}$ , unless otherwise noted)

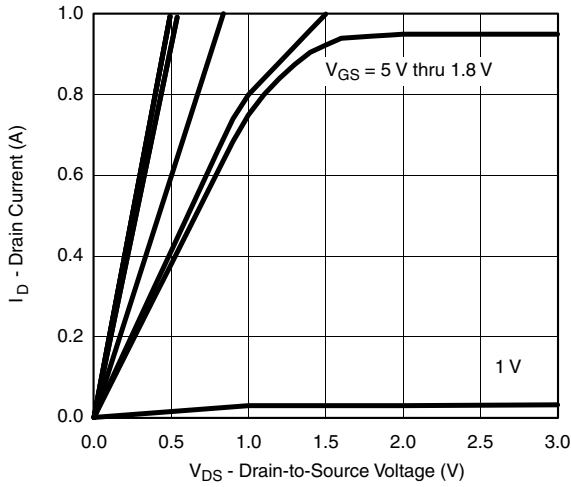

**Output Characteristics**

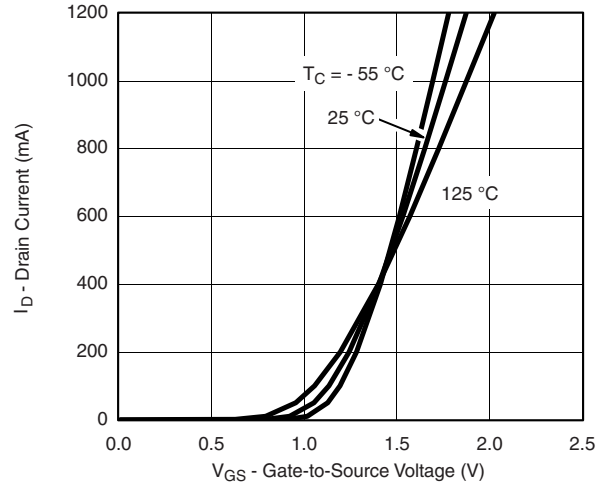

**Transfer Characteristics**

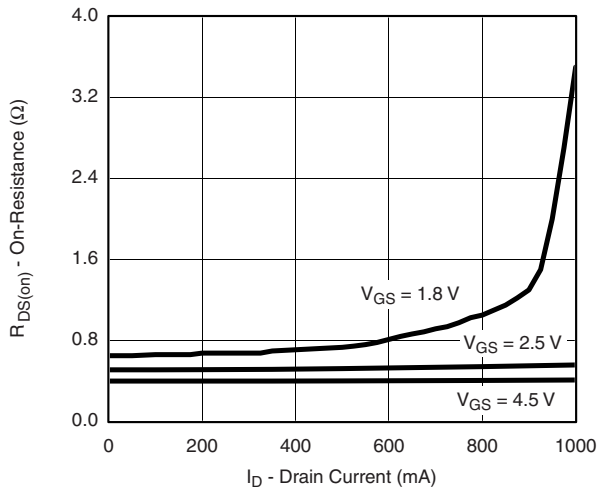

**On-Resistance vs. Drain Current**

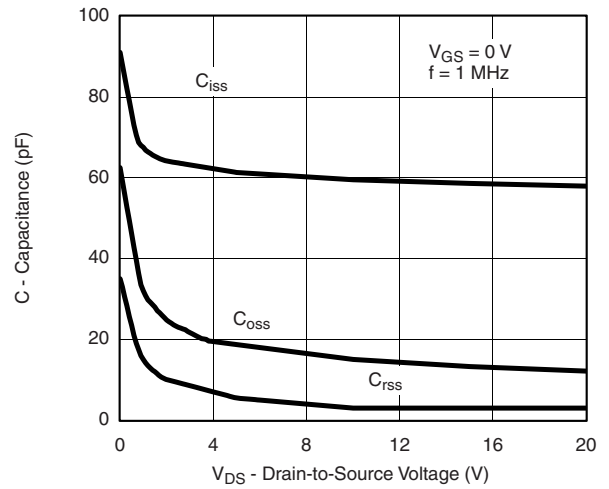

**Capacitance**

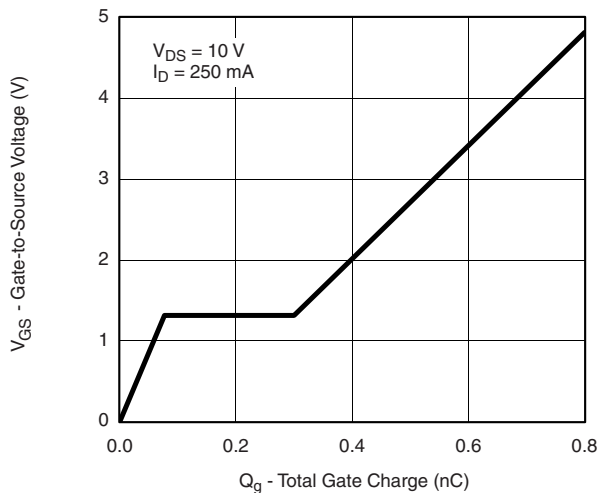

**Gate Charge**

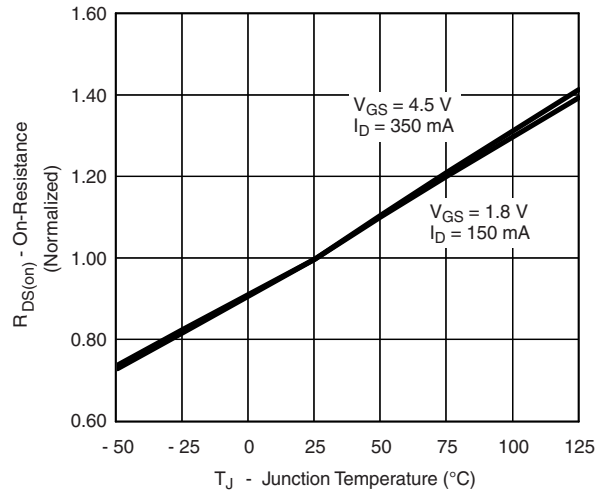

**On-Resistance vs. Junction Temperature**

## N-CHANNEL TYPICAL CHARACTERISTICS ( $T_A = 25\text{ }^\circ\text{C}$ , unless otherwise noted)

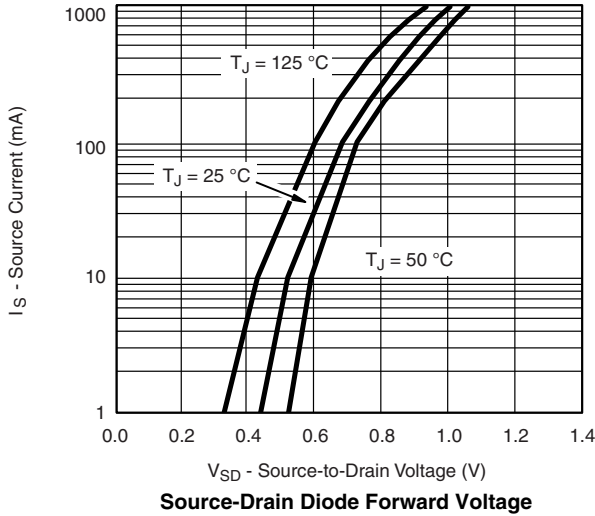

Source-Drain Diode Forward Voltage

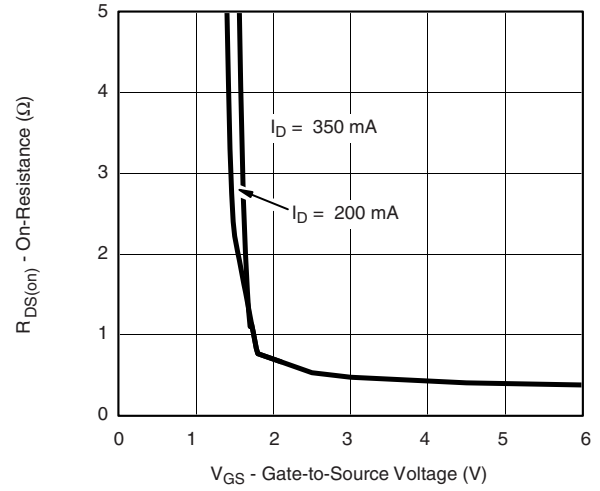

On-Resistance vs. Gate-to-Source Voltage

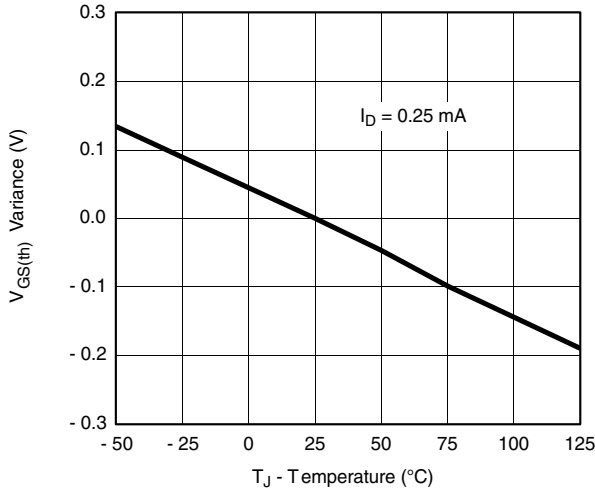

Threshold Voltage Variance vs. Temperature

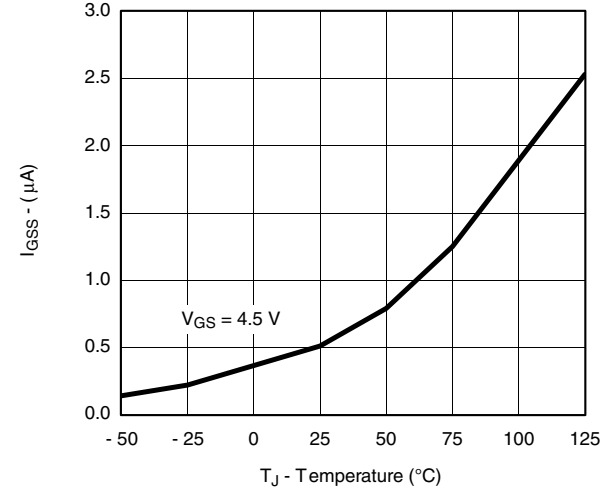

$I_{GSS}$  vs. Temperature

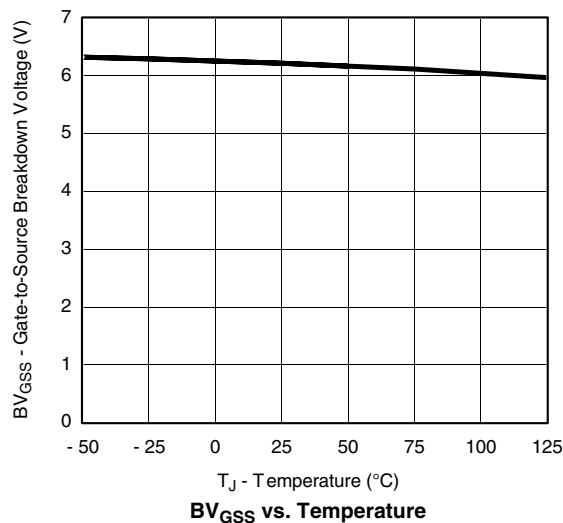

$BV_{GSS}$  vs. Temperature

## P-CHANNEL TYPICAL CHARACTERISTICS ( $T_A = 25\text{ }^\circ\text{C}$ , unless otherwise noted)

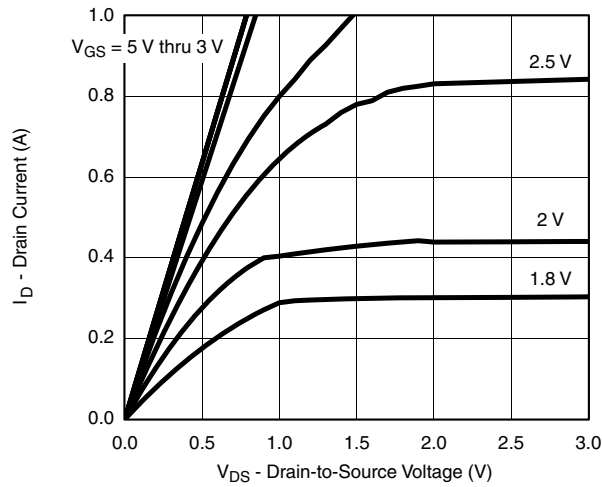

**Output Characteristics**

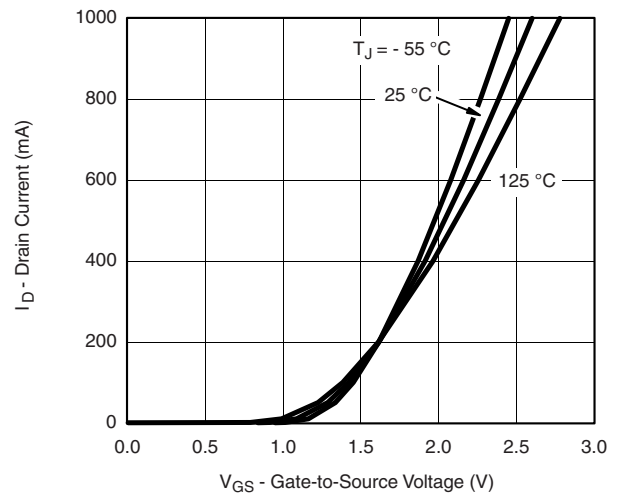

**Transfer Characteristics**

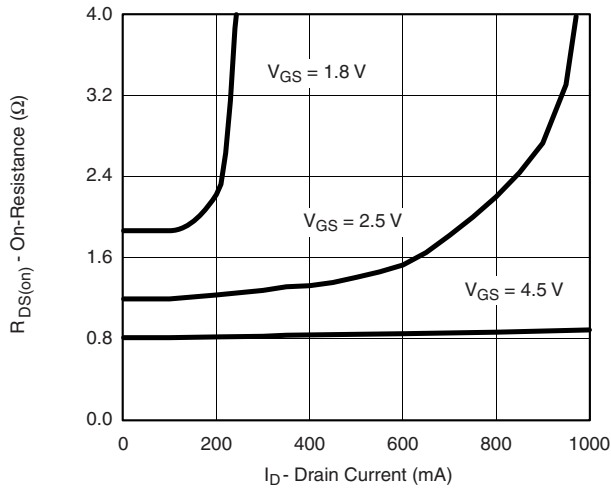

**On-Resistance vs. Drain Current**

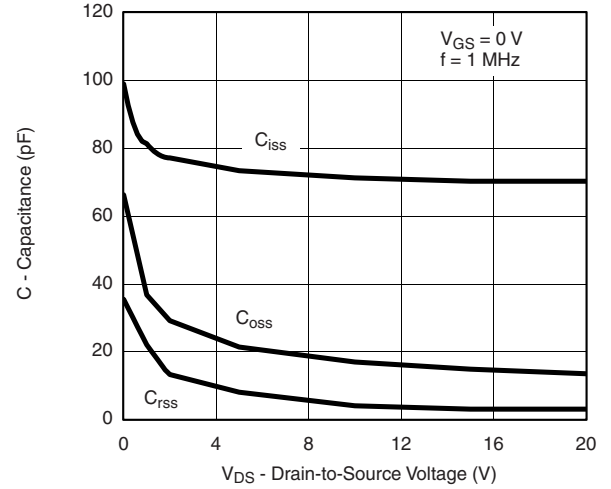

**Capacitance**

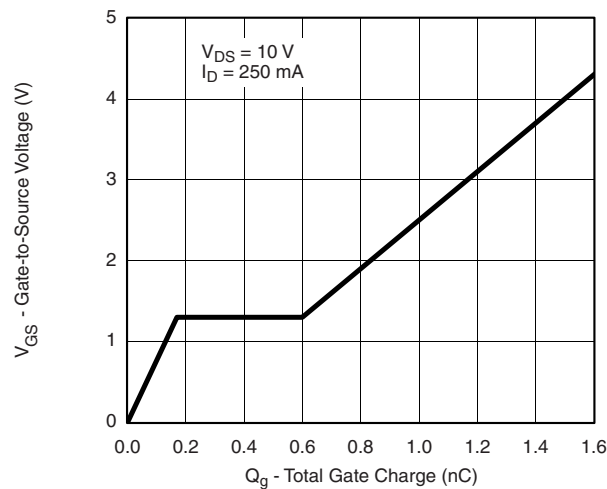

**Gate Charge**

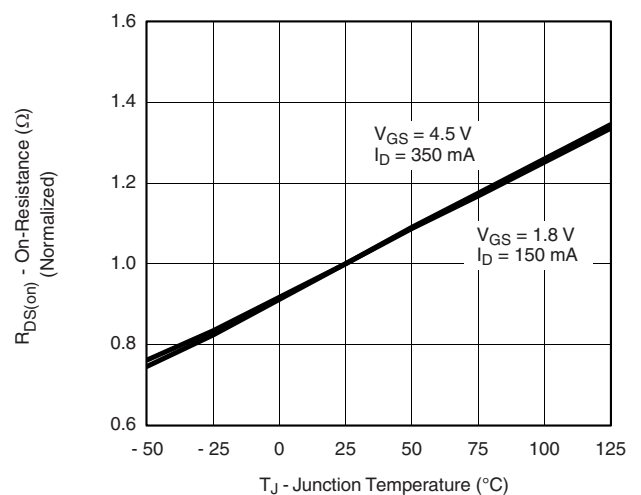

**On-Resistance vs. Junction Temperature**

## P-CHANNEL TYPICAL CHARACTERISTICS ( $T_A = 25\text{ }^\circ\text{C}$ , unless otherwise noted)

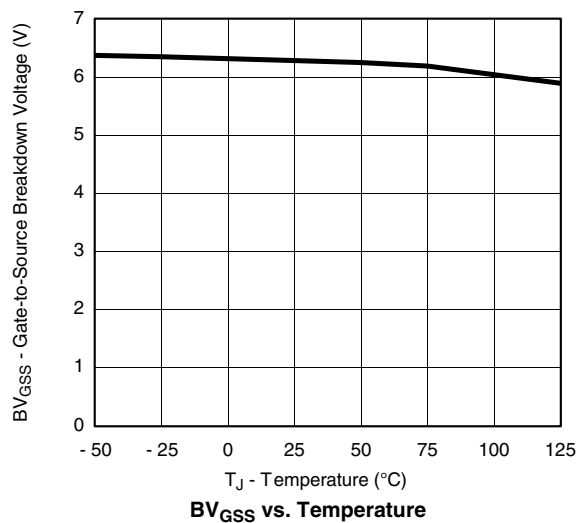
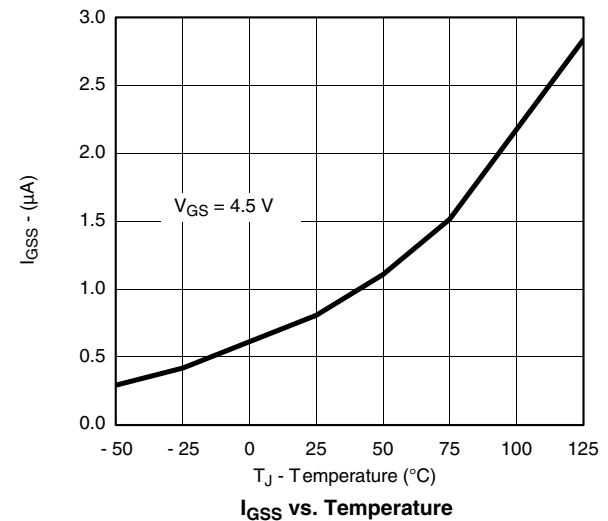
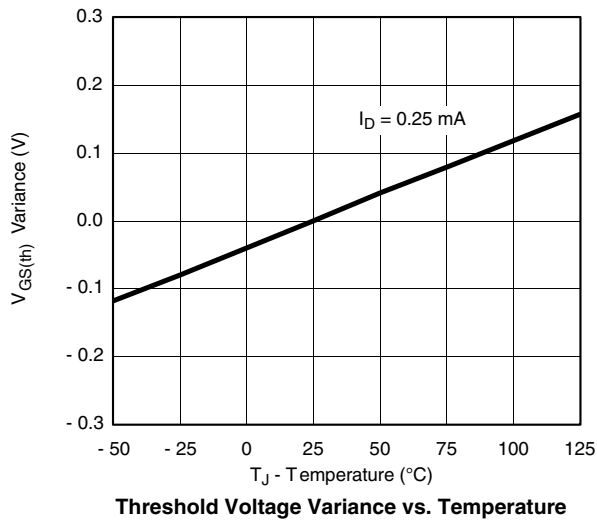
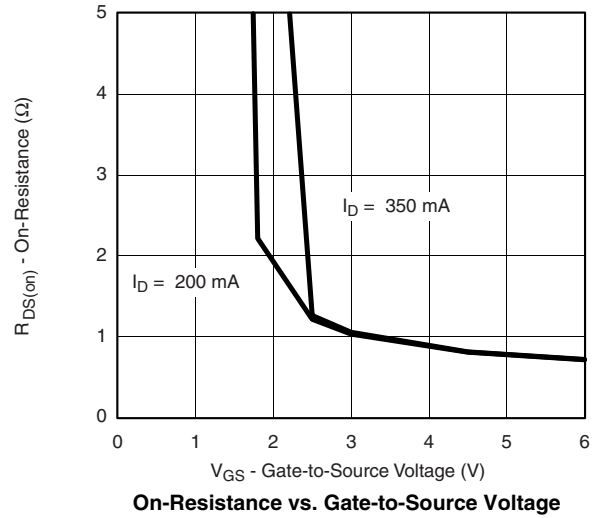
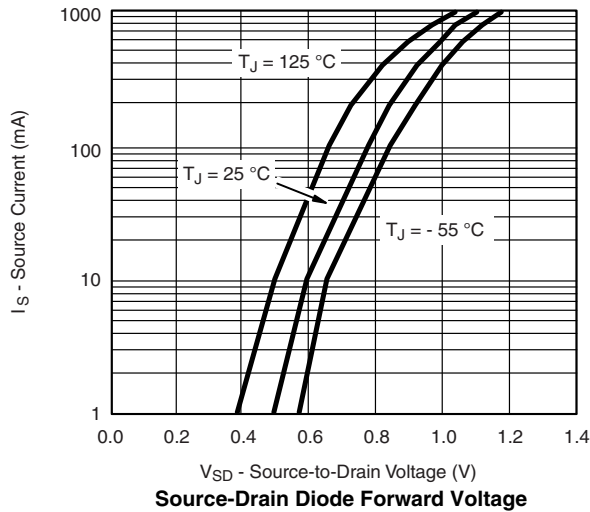

**N- OR P-CHANNEL TYPICAL CHARACTERISTICS** ( $T_A = 25\text{ }^\circ\text{C}$ , unless otherwise noted)

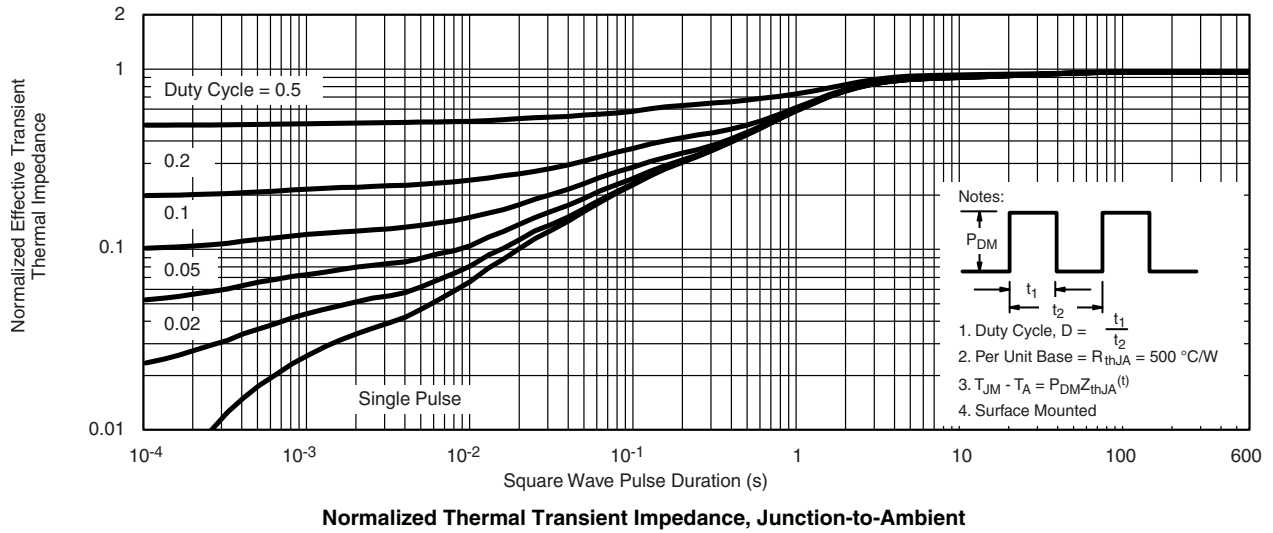

Vishay Siliconix maintains worldwide manufacturing capability. Products may be manufactured at one of several qualified locations. Reliability data for Silicon Technology and Package Reliability represent a composite of all qualified locations. For related documents such as package/tape drawings, part marking, and reliability data, see [www.vishay.com/ppg?71168](http://www.vishay.com/ppg?71168).

### SC-89 6-Leads (SOT-563F)



**Notes**

- 1. Dimensions in millimeters.
- ⚠ Dimension D does not include mold flash, protrusions or gate burrs. Mold flash, protrusions or gate burrs shall not exceed 0.15 mm per dimension E1 does not include interlead flash or protrusion, interlead flash or protrusion shall not exceed 0.15 mm per side.
- ⚠ Dimensions D and E1 are determined at the outmost extremes of the plastic body exclusive of mold flash, the bar burrs, gate burrs and interlead flash, but including any mismatch between the top and the bottom of the plastic body.
- ⚠ Datums A, B and D to be determined 0.10 mm from the lead tip.
- ⚠ Terminal numbers are shown for reference only.
- ⚠ These dimensions apply to the flat section of the lead between 0.08 mm and 0.15 mm from the lead tip.

DIM.	MILLIMETERS		
	MIN.	NOM.	MAX.
A	0.56	0.58	0.60
A1	0	0.02	0.10
b	0.15	0.22	0.30
c	0.10	0.14	0.18
D	1.50	1.60	1.70
E	1.50	1.60	1.70
E1	1.15	1.20	1.25
e	0.45	0.50	0.55
e1	0.95	1.00	1.05
L	0.25	0.35	0.50
L1	0.10	0.20	0.30

C14-0439-Rev. C, 11-Aug-14  
DWG: 5880



## RECOMMENDED MINIMUM PADS FOR SC-89: 6-Lead



Recommended Minimum Pads  
Dimensions in Inches/(mm)

[Return to Index](#)



## Disclaimer

ALL PRODUCT, PRODUCT SPECIFICATIONS AND DATA ARE SUBJECT TO CHANGE WITHOUT NOTICE TO IMPROVE RELIABILITY, FUNCTION OR DESIGN OR OTHERWISE.

Vishay Intertechnology, Inc., its affiliates, agents, and employees, and all persons acting on its or their behalf (collectively, "Vishay"), disclaim any and all liability for any errors, inaccuracies or incompleteness contained in any datasheet or in any other disclosure relating to any product.

Vishay makes no warranty, representation or guarantee regarding the suitability of the products for any particular purpose or the continuing production of any product. To the maximum extent permitted by applicable law, Vishay disclaims (i) any and all liability arising out of the application or use of any product, (ii) any and all liability, including without limitation special, consequential or incidental damages, and (iii) any and all implied warranties, including warranties of fitness for particular purpose, non-infringement and merchantability.

Statements regarding the suitability of products for certain types of applications are based on Vishay's knowledge of typical requirements that are often placed on Vishay products in generic applications. Such statements are not binding statements about the suitability of products for a particular application. It is the customer's responsibility to validate that a particular product with the properties described in the product specification is suitable for use in a particular application. Parameters provided in datasheets and / or specifications may vary in different applications and performance may vary over time. All operating parameters, including typical parameters, must be validated for each customer application by the customer's technical experts. Product specifications do not expand or otherwise modify Vishay's terms and conditions of purchase, including but not limited to the warranty expressed therein.

Hyperlinks included in this datasheet may direct users to third-party websites. These links are provided as a convenience and for informational purposes only. Inclusion of these hyperlinks does not constitute an endorsement or an approval by Vishay of any of the products, services or opinions of the corporation, organization or individual associated with the third-party website. Vishay disclaims any and all liability and bears no responsibility for the accuracy, legality or content of the third-party website or for that of subsequent links.

Except as expressly indicated in writing, Vishay products are not designed for use in medical, life-saving, or life-sustaining applications or for any other application in which the failure of the Vishay product could result in personal injury or death. Customers using or selling Vishay products not expressly indicated for use in such applications do so at their own risk. Please contact authorized Vishay personnel to obtain written terms and conditions regarding products designed for such applications.

No license, express or implied, by estoppel or otherwise, to any intellectual property rights is granted by this document or by any conduct of Vishay. Product names and markings noted herein may be trademarks of their respective owners.

单击下面可查看定价，库存，交付和生命周期等信息

[>>Vishay\(威世\)](#)