

## Power MOSFET

**RoHS**  
COMPLIANT

PRODUCT SUMMARY	
$V_{DS}$ (V)	-50
$R_{DS(on)}$ ( $\Omega$ )	$V_{GS} = -10$ V   0.28
$Q_g$ max. (nC)	26
$Q_{gs}$ (nC)	6.2
$Q_{gd}$ (nC)	8.6
Configuration	Single

### FEATURES

- P-channel versatility
- Compact plastic package
- Fast switching
- Low drive current
- Ease of paralleling
- Excellent temperature stability
- Material categorization: for definitions of compliance please see [www.vishay.com/doc?99912](http://www.vishay.com/doc?99912)

### DESCRIPTION

The power MOSFET technology is the key to Vishay's advanced line of power MOSFET transistors. The efficient geometry and unique processing of the power MOSFET design achieve very low on-state resistance combined with high transconductance and extreme device ruggedness.

The P-channel power MOSFETs are designed for application which require the convenience of reverse polarity operation. They retain all of the features of the more common N-channel power MOSFETs such as voltage control, very fast switching, ease of paralleling, and excellent temperature stability.

P-channel power MOSFETs are intended for use in power stages where complementary symmetry with N-channel devices offers circuit simplification. They are also very useful in drive stages because of the circuit versatility offered by the reverse polarity connection. Applications include motor control, audio amplifiers, switched mode converters, control circuits and pulse amplifiers.

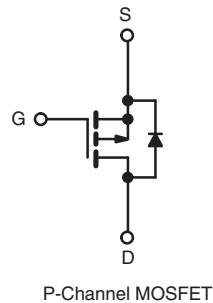
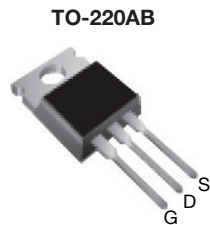

ORDERING INFORMATION	
Package	TO-220AB
Lead (Pb)-free	IRF9Z20PbF



ABSOLUTE MAXIMUM RATINGS ( $T_C = 25^\circ\text{C}$ , unless otherwise noted)				
PARAMETER		SYMBOL	LIMIT	UNIT
Drain-Source Voltage		$V_{DS}$	-50	V
Gate-Source Voltage		$V_{GS}$	$\pm 20$	
Continuous Drain Current	$V_{GS}$ at -10 V	$I_D$	$T_C = 25^\circ\text{C}$	-9.7
			$T_C = 100^\circ\text{C}$	-6.1
Pulsed Drain Current <sup>a</sup>		$I_{DM}$	-39	A
Linear Derating Factor			0.32	W/ $^\circ\text{C}$
Inductive Current, Clamped	L = 100 $\mu\text{H}$	$I_{LM}$	-39	A
Unclamped Inductive Current (Avalanche current)		$I_L$	-2.2	A
Maximum Power Dissipation	$T_C = 25^\circ\text{C}$	$P_D$	40	W
Operating Junction and Storage Temperature Range		$T_J, T_{stg}$	-55 to +150	$^\circ\text{C}$
Soldering Recommendations (Peak temperature) <sup>c</sup>	for 10 s		300	

### Notes

- Repetitive rating; pulse width limited by maximum junction temperature (see fig. 14).
- $V_{DD} = -25$  V, starting  $T_J = 25^\circ\text{C}$ , L = 100  $\mu\text{H}$ ,  $R_g = 25 \Omega$
- 0.063" (1.6 mm) from case.

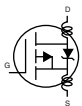

THERMAL RESISTANCE RATINGS				
PARAMETER	SYMBOL	TYP.	MAX.	UNIT
Maximum Junction-to-Ambient	$R_{thJA}$	-	80	°C/W
Case-to-Sink, Flat, Greased Surface	$R_{thCS}$	1.0	-	
Maximum Junction-to-Case (Drain)	$R_{thJC}$	-	3.1	

SPECIFICATIONS ( $T_J = 25\text{ }^\circ\text{C}$ , unless otherwise noted)							
PARAMETER	SYMBOL	TEST CONDITIONS		MIN.	TYP.	MAX.	UNIT
<b>Static</b>							
Drain-Source Breakdown Voltage	$V_{DS}$	$V_{GS} = 0\text{ V}, I_D = -250\text{ }\mu\text{A}$		-50	-	-	V
Gate-Source Threshold Voltage	$V_{GS(th)}$	$V_{DS} = V_{GS}, I_D = -250\text{ }\mu\text{A}$		-2.0	-	-4.0	V
Gate-Source Leakage	$I_{GSS}$	$V_{GS} = \pm 20\text{ V}$		-	-	$\pm 500$	nA
Zero Gate Voltage Drain Current	$I_{DSS}$	$V_{DS} = \text{max. rating}, V_{GS} = 0\text{ V}$		-	-	-250	$\mu\text{A}$
		$V_{DS} = \text{max. rating} \times 0.8, V_{GS} = 0\text{ V}, T_J = 125\text{ }^\circ\text{C}$		-	-	-1000	
Drain-Source On-State Resistance	$R_{DS(on)}$	$V_{GS} = -10\text{ V}$	$I_D = -5.6\text{ A}^b$	-	0.20	0.28	$\Omega$
Forward Transconductance	$g_{fs}$	$V_{DS} = 2 \times V_{GS}, I_{DS} = -5.6\text{ A}^b$		2.3	3.5	-	S
<b>Dynamic</b>							
Input Capacitance	$C_{iss}$	$V_{GS} = 0\text{ V},$ $V_{DS} = -25\text{ V},$ $f = 1.0\text{ MHz, see fig. 9}$		-	480	-	$\mu\text{F}$
Output Capacitance	$C_{oss}$			-	320	-	
Reverse Transfer Capacitance	$C_{rss}$			-	58	-	
Total Gate Charge	$Q_g$	$V_{GS} = -10\text{ V}$	$I_D = -9.7\text{ A}, V_{DS} = -0.8\text{ max. rating, see fig. 17}$	-	17	26	nC
Gate-Source Charge	$Q_{gs}$			-	4.1	6.2	
Gate-Drain Charge	$Q_{gd}$			-	5.7	8.6	
Turn-On Delay Time	$t_{d(on)}$	$V_{DD} = -25\text{ V}, I_D = -9.7\text{ A},$ $R_g = 18\text{ }\Omega, R_D = 2.4\text{ }\Omega,$ see fig. 16 (MOSFET switching times are essentially independent of operating temperature)		-	8.2	12	ns
Rise Time	$t_r$			-	57	86	
Turn-Off Delay Time	$t_{d(off)}$			-	12	18	
Fall Time	$t_f$			-	25	38	
Internal Drain Inductance	$L_D$	Between lead, 6 mm (0.25") from package and center of die contact 		-	4.5	-	nH
Internal Source Inductance	$L_S$			-	7.5	-	
<b>Drain-Source Body Diode Characteristics</b>							
Continuous Source-Drain Diode Current	$I_S$	MOSFET symbol showing the integral reverse p - n junction diode 		-	-	-9.7	A
Pulsed Diode Forward Current <sup>a</sup>	$I_{SM}$			-	-	-39	
Body Diode Voltage	$V_{SD}$	$T_J = 25\text{ }^\circ\text{C}, I_S = -9.7\text{ A}, V_{GS} = 0\text{ V}^b$		-	-	-6.3	V
Body Diode Reverse Recovery Time	$t_{rr}$	$T_J = 25\text{ }^\circ\text{C}, I_F = -9.7\text{ A}, di/dt = 100\text{ A}/\mu\text{s}^b$		56	110	280	ns
Body Diode Reverse Recovery Charge	$Q_{rr}$			0.17	0.34	0.85	$\mu\text{C}$
Forward Turn-On Time	$t_{on}$	Intrinsic turn-on time is negligible (turn-on is dominated by $L_S$ and $L_D$ )					

**Notes**

- a. Repetitive rating; pulse width limited by maximum junction temperature (see fig. 14).
- b. Pulse width  $\leq 300\text{ }\mu\text{s}$ ; duty cycle  $\leq 2\%$ .

## TYPICAL CHARACTERISTICS (25 °C, unless otherwise noted)

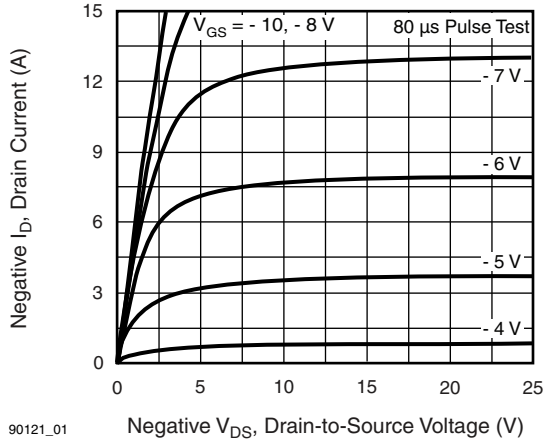

Fig. 1 - Typical Output Characteristics

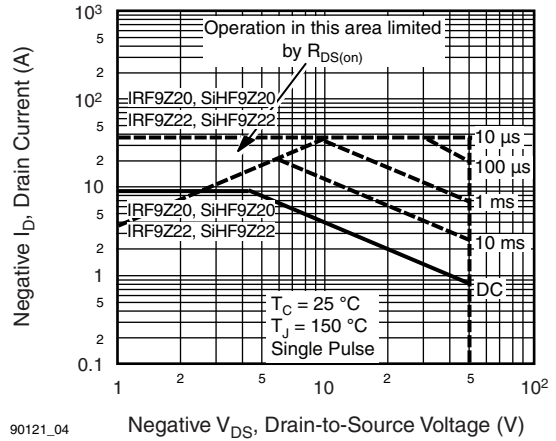

Fig. 4 - Maximum Safe Operating Area

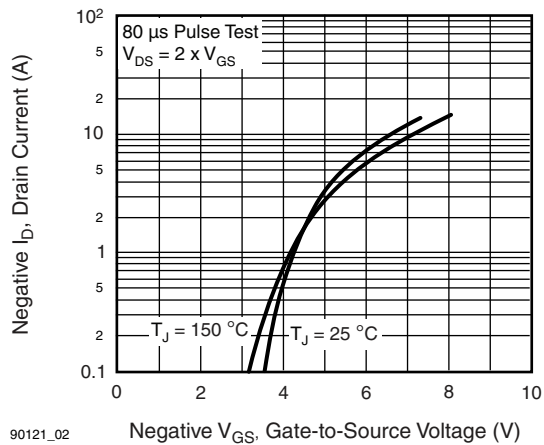

Fig. 2 - Typical Transfer Characteristics

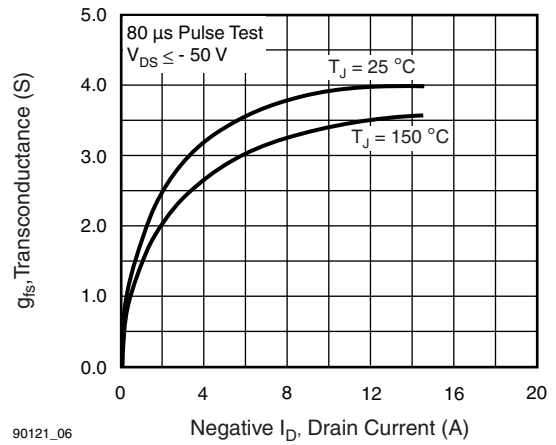

Fig. 5 - Typical Transconductance vs. Drain Current

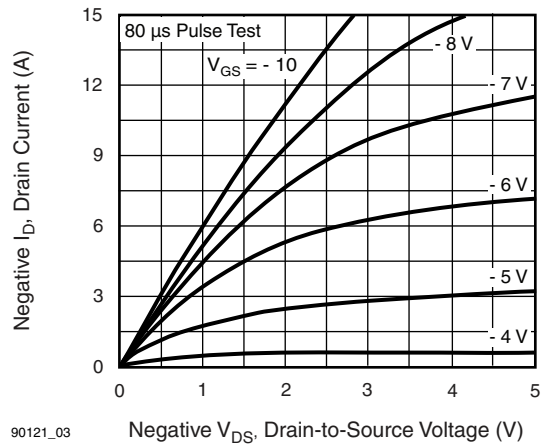

Fig. 3 - Typical Saturation Characteristics

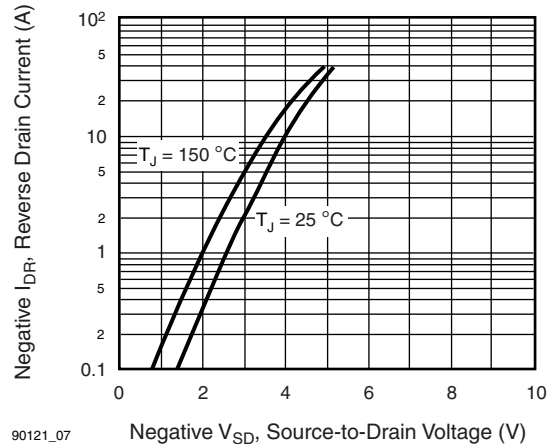

Fig. 6 - Typical Source-Drain Diode Forward Voltage

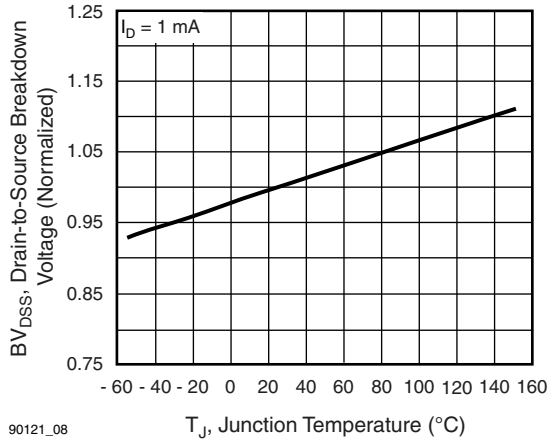

Fig. 7 - Breakdown Voltage vs. Temperature

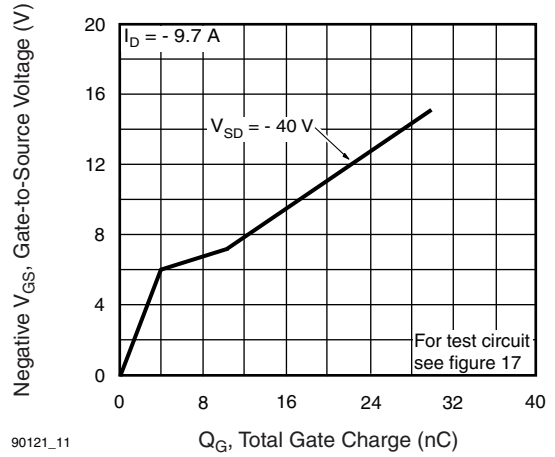

Fig. 10 - Typical Gate Charge vs. Gate-to-Source Voltage

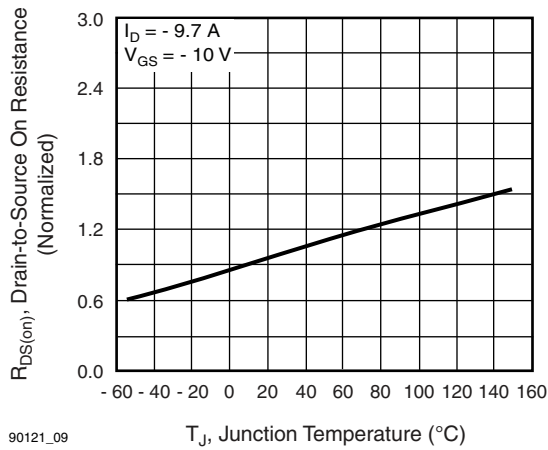

Fig. 8 - Normalized On-Resistance vs. Temperature

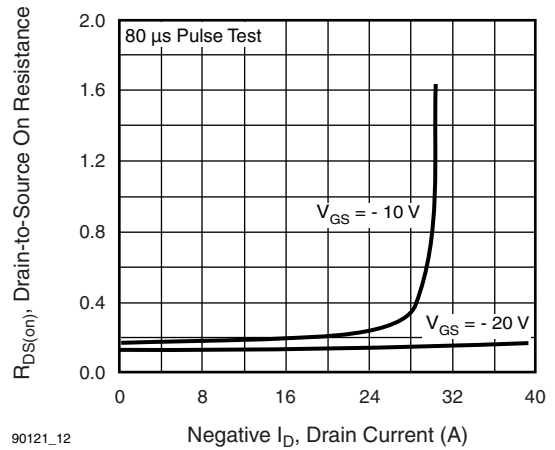

Fig. 11 - Typical On-Resistance vs. Drain Current

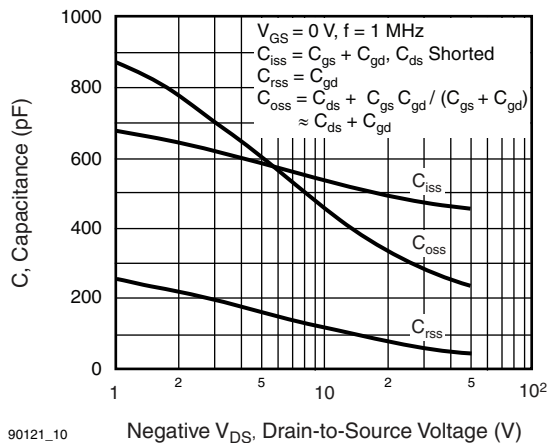

Fig. 9 - Typical Capacitance vs. Drain-to-Source Voltage

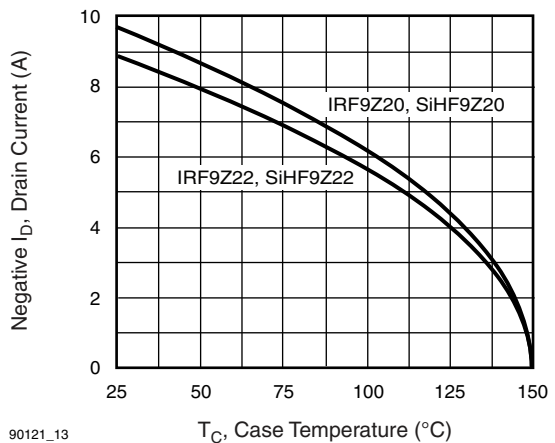

Fig. 12 - Maximum Drain Current vs. Case Temperature

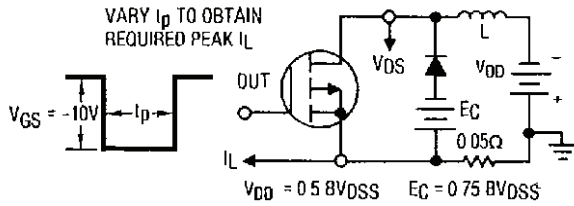

Fig. 13a - Unclamped Inductive Test Circuit

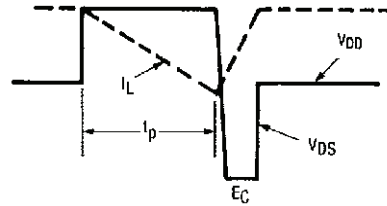
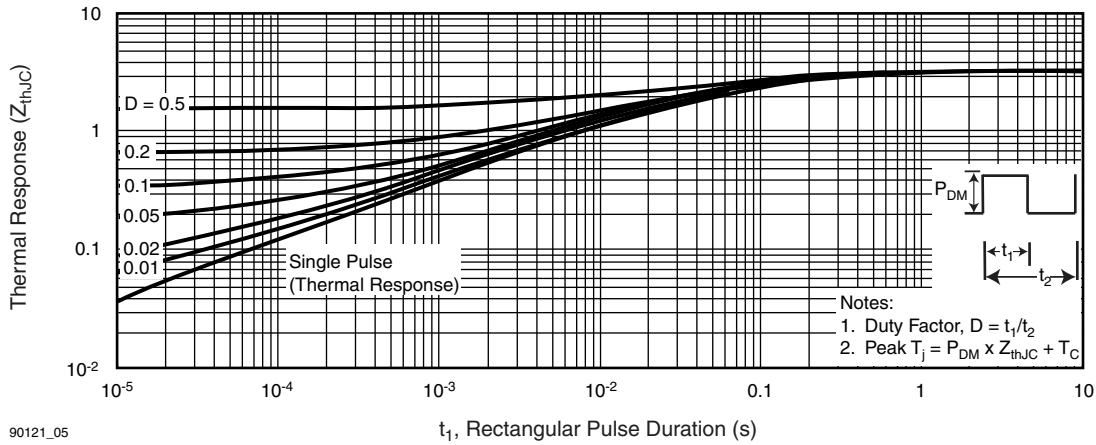

Fig. 13b - Unclamped Inductive Load Test Waveforms



90121\_05

Fig. 14 - Maximum Effective Transient Thermal Impedance, Junction-to-Case vs. Pulse Duration

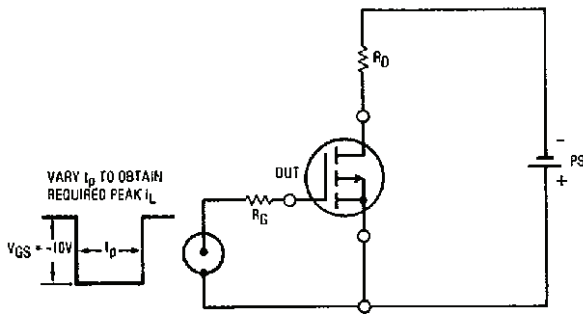

Fig. 15 - Switching Time Test Circuit

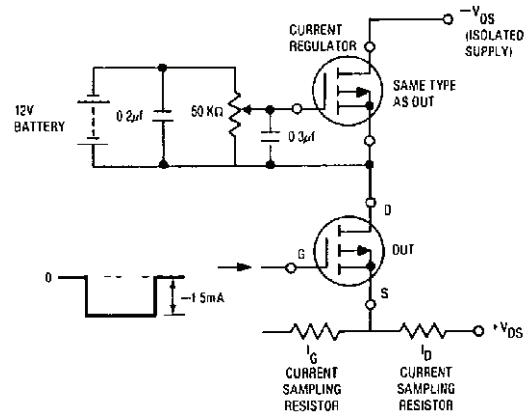
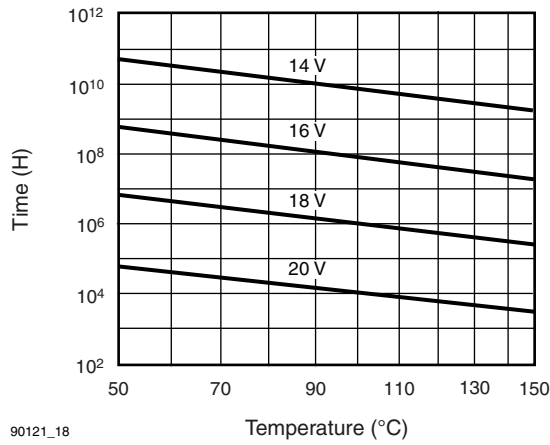
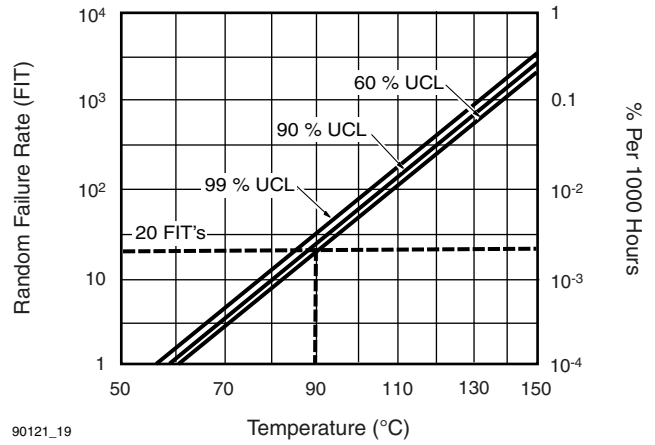

Fig. 16 - Gate Charge Test Circuit



90121\_18

Fig. 17 - Typical Time to Accumulated 1 % Gate Failure



90121\_19

Fig. 18 - Typical High Temperature Reverse Bias (HTRB) Failure Rate

Vishay Siliconix maintains worldwide manufacturing capability. Products may be manufactured at one of several qualified locations. Reliability data for Silicon Technology and Package Reliability represent a composite of all qualified locations. For related documents such as package/tape drawings, part marking, and reliability data, see [www.vishay.com/ppg?90121](http://www.vishay.com/ppg?90121).



## Disclaimer

ALL PRODUCT, PRODUCT SPECIFICATIONS AND DATA ARE SUBJECT TO CHANGE WITHOUT NOTICE TO IMPROVE RELIABILITY, FUNCTION OR DESIGN OR OTHERWISE.

Vishay Intertechnology, Inc., its affiliates, agents, and employees, and all persons acting on its or their behalf (collectively, "Vishay"), disclaim any and all liability for any errors, inaccuracies or incompleteness contained in any datasheet or in any other disclosure relating to any product.

Vishay makes no warranty, representation or guarantee regarding the suitability of the products for any particular purpose or the continuing production of any product. To the maximum extent permitted by applicable law, Vishay disclaims (i) any and all liability arising out of the application or use of any product, (ii) any and all liability, including without limitation special, consequential or incidental damages, and (iii) any and all implied warranties, including warranties of fitness for particular purpose, non-infringement and merchantability.

Statements regarding the suitability of products for certain types of applications are based on Vishay's knowledge of typical requirements that are often placed on Vishay products in generic applications. Such statements are not binding statements about the suitability of products for a particular application. It is the customer's responsibility to validate that a particular product with the properties described in the product specification is suitable for use in a particular application. Parameters provided in datasheets and / or specifications may vary in different applications and performance may vary over time. All operating parameters, including typical parameters, must be validated for each customer application by the customer's technical experts. Product specifications do not expand or otherwise modify Vishay's terms and conditions of purchase, including but not limited to the warranty expressed therein.

Except as expressly indicated in writing, Vishay products are not designed for use in medical, life-saving, or life-sustaining applications or for any other application in which the failure of the Vishay product could result in personal injury or death. Customers using or selling Vishay products not expressly indicated for use in such applications do so at their own risk. Please contact authorized Vishay personnel to obtain written terms and conditions regarding products designed for such applications.

No license, express or implied, by estoppel or otherwise, to any intellectual property rights is granted by this document or by any conduct of Vishay. Product names and markings noted herein may be trademarks of their respective owners.

单击下面可查看定价，库存，交付和生命周期等信息

[>>Vishay\(威世\)](#)