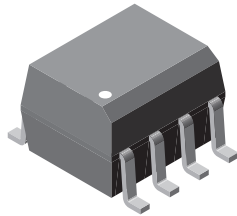
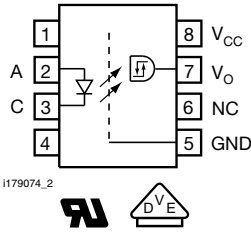


High Speed Optocoupler, Single, 5 MBd, in SOIC-8 Package



i179074



FEATURES

- Data rate 5 Mbits/s (2.5 Mbit/s over temperature)
- Buffer
- Isolation test voltage, 4000 V_{RMS}
- TTL, LSTTL and CMOS compatible
- Internal shield for very high common mode transient immunity
- Wide supply voltage range (4.5 V to 15 V)
- Low input current (1.6 mA to 5 mA)
- Parameters specified from 0 °C to 85 °C
- T_{amb} from -40 °C to 100 °C
- Material categorization: for definitions of compliance please see www.vishay.com/doc?99912



RoHS
COMPLIANT

DESCRIPTION

The single channel 5 Mb/s SFH6720 and SFH6721 high speed optocoupler consists of a GaAlAs infrared emitting diode, optically coupled with an integrated photo detector. The detector incorporates a Schmitt-trigger stage for improved noise immunity. A Faraday shield provides a common mode transient immunity of 1000 V/μs at V_{CM} = 50 V for SFH6720 and 2500 V/μs at V_{CM} = 400 V for SFH6721.

AGENCY APPROVALS

- UL1577, file no. E52744 system code Y
- DIN EN 60747-5-5 (VDE 0884) available with option 1

APPLICATIONS

- Industrial control
- Replace pulse transformers
- Routine logic interfacing
- Motion / power control
- High speed line receiver
- Microprocessor system interfaces
- Computer peripheral interfaces

ORDERING INFORMATION		
<div style="display: flex; justify-content: space-around; align-items: center;"> <div style="border: 1px solid black; padding: 2px 5px;">S</div> <div style="border: 1px solid black; padding: 2px 5px;">F</div> <div style="border: 1px solid black; padding: 2px 5px;">H</div> <div style="border: 1px solid black; padding: 2px 5px;">6</div> <div style="border: 1px solid black; padding: 2px 5px;">7</div> <div style="border: 1px solid black; padding: 2px 5px;">2</div> <div style="border: 1px solid black; padding: 2px 5px;">#</div> </div> <p style="text-align: center;">PART NUMBER</p>	<div style="border: 1px solid black; padding: 2px 5px;">T</div> <p style="text-align: center;">TAPE AND REEL</p>	
AGENCY CERTIFIED/PACKAGE	CMR (kV/μs)	CMR (kV/μs)
UL	1	2.5
SOIC-8	SFH6720T	SFH6721T
VDE, UL	1	2.5
SOIC-8	SFH6720-X001T	-

TRUTH TABLE (positive logic)		
PART	IR DIODE	OUTPUT
SFH6720	On	H
	Off	L
SFH6721	On	H
	Off	L



ABSOLUTE MAXIMUM RATINGS ⁽¹⁾ ($T_{amb} = 25\text{ }^{\circ}\text{C}$, unless otherwise specified)				
PARAMETER	TEST CONDITION	SYMBOL	VALUE	UNIT
INPUT				
Reverse voltage		V_R	3	V
DC forward current		I_F	10	mA
Surge forward	$t_p \leq 1\text{ }\mu\text{s}$, 300 pulses/s	I_{FSM}	1	mA
Power dissipation		P_{diss}	20	mW
OUTPUT				
Supply voltage		V_{CC}	-0.5 to +15	V
Output voltage		V_O	-0.5 to +15	V
Average output current		I_O	25	mA
Power dissipation		P_{diss}	100	mW
COUPLER				
Storage temperature range		T_{stg}	-55 to +125	$^{\circ}\text{C}$
Ambient temperature range		T_{amb}	+ 85	$^{\circ}\text{C}$
Lead soldering temperature	$t = 10\text{ s}$	T_{slid}	260	$^{\circ}\text{C}$

Note

- ⁽¹⁾ Stresses in excess of the absolute maximum ratings can cause permanent damage to the device. Functional operation of the device is not implied at these or any other conditions in excess of those given in the operational sections of this document. Exposure to absolute maximum ratings for extended periods of the time can adversely affect reliability.

RECOMMENDED OPERATING CONDITIONS ⁽¹⁾						
PARAMETER	TEST CONDITION	SYMBOL	MIN.	TYP.	MAX.	UNIT
Supply voltage		V_{CC}	4.5		15	V
Forward input current		I_{Fon}	1.6 ⁽²⁾		5	mA
		I_{Foff}			0.1	mA
Operating temperature		T_A	-40		85	$^{\circ}\text{C}$

Notes

- ⁽¹⁾ A 0.1 μF bypass capacitor connected between pins 5 and 8 must be used.
⁽²⁾ We recommended using a 2.2 mA if to permit at least 20 % CTR degradation guard band.

ELECTRICAL CHARACTERISTICS ⁽¹⁾						
PARAMETER	TEST CONDITION	SYMBOL	MIN.	TYP.	MAX.	UNIT
INPUT						
Forward voltage	$I_F = 5\text{ mA}$, $25\text{ }^{\circ}\text{C}$	V_F		1.6	1.75	V
		V_F			1.9	V
Input current hysteresis	$V_{CC} = 5\text{ V}$, $I_{HYS} = I_{Fon} - I_{Foff}$	I_{HYS}	0.1			V
Reverse current	$V_R = 3\text{ V}$	I_R		0.5	10	μA
Capacitance	$V_R = 0\text{ V}$, $f = 1\text{ MHz}$	C_O		60		pF
Thermal resistance		R_{thja}		700		K/W

ELECTRICAL CHARACTERISTICS (1)						
PARAMETER	TEST CONDITION	SYMBOL	MIN.	TYP.	MAX.	UNIT
OUTPUT						
Logic low output voltage	$I_{OL} = 6.4 \text{ mA}$	V_{OL}			0.5	V
Logic high output voltage	$I_{OH} = -2.6 \text{ mA}$, $V_{OH} = V_{CC} - 1.8 \text{ V}$	V_{OH}	2.4			V
Output leakage current ($V_{OUT} > V_{CC}$)	$V_O = 5.5 \text{ V}$, $V_{CC} = 4.5 \text{ V}$, $I_F = 5 \text{ mA}$	I_{OHH}		0.5	100	μA
	$V_O = 15 \text{ V}$, $V_{CC} = 4.5 \text{ V}$, $I_F = 5 \text{ mA}$	I_{OHH}		1	500	μA
Logic low supply current	$V_{CC} = 5.5 \text{ V}$, $I_F = 0$	I_{CCL}		3.7	6	mA
	$V_{CC} = 15 \text{ V}$, $I_F = 0$	I_{CCL}		4.1	6.5	mA
Logic high supply current	$V_{CC} = 5.5 \text{ V}$, $I_F = 5 \text{ mA}$	I_{CCH}		3.4	4	mA
	$V_{CC} = 15 \text{ V}$, $I_F = 5 \text{ mA}$	I_{CCH}		3.7	5	mA
Logic low short circuit output current (output short circuit time $\leq 10 \text{ ms}$)	$V_O = V_{CC} = 5.5 \text{ V}$, $I_F = 0$	I_{OSL}	25			mA
	$V_O = V_{CC} = 15 \text{ V}$, $I_F = 0$	I_{OSL}	40			mA
Logic high short circuit output current (output short circuit time $\leq 10 \text{ ms}$)	$V_{CC} = 5.5 \text{ V}$, $V_O = 0 \text{ V}$, $I_F = 5 \text{ mA}$	I_{OSH}			-10	mA
	$V_{CC} = 15 \text{ V}$, $V_O = 0 \text{ V}$, $I_F = 5 \text{ mA}$	I_{OSH}			-25	mA
Thermal resistance		R_{thja}		300		K/W
COUPLER						
Capacitance (input to output)	$f = 1 \text{ MHz}$, pins 1 to 4 and 5 to 8 shorted together	C_{IO}		0.6		pF

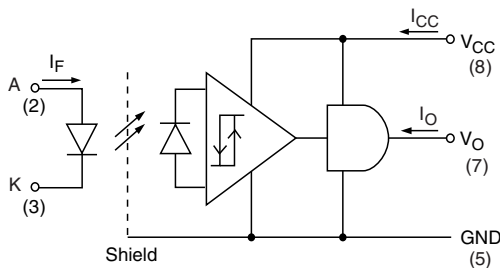
Note

- (1) $-40^\circ\text{C} \leq T_{amb} \leq 85^\circ\text{C}$; $4.5 \text{ V} \leq V_{CC} \leq 15 \text{ V}$; $1.6 \text{ mA} \leq I_{Fon} \leq 5 \text{ mA}$; $2 \leq V_{EH} \leq 15 \text{ V}$; $0 \leq V_{EL} \leq 0.8 \text{ V}$; $0 \text{ mA} \leq I_{Foff} \leq 0.1 \text{ mA}$.
 Typical values: $T_{amb} = 25^\circ\text{C}$; $V_{CC} = 5 \text{ V}$; $I_{Fon} = 3 \text{ mA}$ unless otherwise specified.
 Minimum and maximum values are testing requirements. Typical values are characteristics of the device and are the result of engineering evaluation. Typical values are for information only and are not part of the testing requirements.

SWITCHING CHARACTERISTICS (1)						
PARAMETER	TEST CONDITION	SYMBOL	MIN.	TYP.	MAX.	UNIT
Propagation delay time to logic low output level	Without peaking capacitor	t_{PHL}		120		ns
	With peaking capacitor	t_{PHL}		115	300	ns
Propagation delay time to logic high output level	Without peaking capacitor	t_{PLH}		125		ns
	With peaking capacitor	t_{PLH}		90	300	ns
Output rise time	10 % to 90 %	t_r		40		ns
Output fall time	90 % to 10 %	t_f		10		ns

Note

- (1) $0^\circ\text{C} \leq T_{amb} \leq 85^\circ\text{C}$; $4.5 \text{ V} \leq V_{CC} \leq 15 \text{ V}$; $1.6 \text{ mA} \leq I_{Fon} \leq 5 \text{ mA}$; $0 \text{ mA} \leq I_{Foff} \leq 0.1 \text{ mA}$.
 Typical values: $T_{amb} = 25^\circ\text{C}$; $V_{CC} = 5 \text{ V}$; $I_{Fon} = 3 \text{ mA}$ unless otherwise specified. A $0.1 \mu\text{F}$ bypass capacitor connected between pins 5 and 8 must be used.



isfh6720_00

COMMON MODE TRANSIENT IMMUNITY (1)

PARAMETER	TEST CONDITION	PART	SYMBOL	MIN.	TYP.	MAX.	UNIT
Logic high common mode transient immunity (2)	$ V_{CM} = 50 \text{ V}, I_F = 1.6 \text{ mA}$	SFH6720	$ CM_H $	1000			V/ μ s
	$ V_{CM} = 300 \text{ V}, I_F = 1.6 \text{ mA}$	SFH6721	$ CM_H $	5000			V/ μ s
Logic low common mode transient immunity (2)	$ V_{CM} = 50 \text{ V}, I_F = 0 \text{ mA}$	SFH6720	$ CM_L $	1000			V/ μ s
	$ V_{CM} = 1000 \text{ V}, I_F = 0 \text{ mA}$	SFH6721	$ CM_L $	10 000			V/ μ s

Note

(1) $T_{amb} = 25 \text{ }^\circ\text{C}$, $V_{CC} = 5 \text{ V}$. (2)

(2) CM_H is the maximum slew rate of a common mode voltage V_{CM} at which the output voltage remains at logic high level ($V_O > 2 \text{ V}$). CM_L is the maximum slew rate of a common mode voltage V_{CM} at which the output voltage remains at logic low level ($V_O < 0.8 \text{ V}$).

SAFETY AND INSULATION RATINGS

PARAMETER	TEST CONDITION	SYMBOL	VALUE	UNIT
Climatic classification	According to IEC 68 part 1		55/100/21	
Pollution degree	According to DIN VDE 0109		2	
Comparative tracking index	Insulation group IIIa	CTI	175	
Maximum rated withstanding isolation voltage	According to UL1577, $t = 1 \text{ min}$	V_{ISO}	3333	V_{RMS}
Tested withstanding isolation voltage	According to UL1577, $t = 1 \text{ s}$	V_{ISO}	4000	V_{RMS}
Maximum transient isolation voltage	According to DIN EN 60747-5-5	V_{IOTM}	6000	V_{peak}
Maximum repetitive peak isolation voltage	According to DIN EN 60747-5-5	V_{IORM}	560	V_{peak}
Isolation resistance	$V_{IO} = 500 \text{ V}, T_{amb} = 25 \text{ }^\circ\text{C}$	R_{IO}	$\geq 10^{12}$	Ω
	$V_{IO} = 500 \text{ V}, T_{amb} = 100 \text{ }^\circ\text{C}$	R_{IO}	$\geq 10^{11}$	Ω
Output safety power		P_{SO}	350	mW
Input safety current		I_{SI}	150	mA
Input safety temperature		T_S	165	$^\circ\text{C}$
Creepage distance	SOIC-8		≥ 4	mm
Clearance distance	SOIC-8		≥ 4	mm
Insulation thickness		DTI	≥ 0.2	mm

Note

• As per IEC 60747-5-5, § 7.4.3.8.2, this optocoupler is suitable for “safe electrical insulation” only within the safety ratings. Compliance with the safety ratings shall be ensured by means of protective circuits.

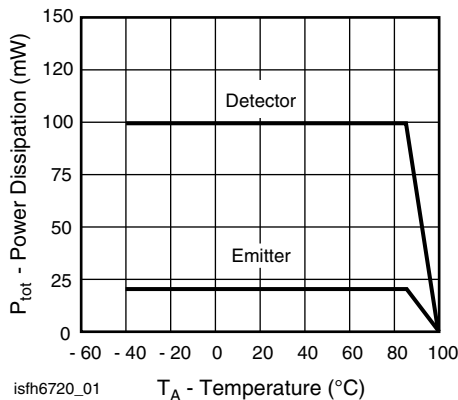
TYPICAL CHARACTERISTICS ($T_{amb} = 25 \text{ }^\circ\text{C}$, unless otherwise specified)


Fig. 1 - Permissible Total Power Dissipation vs. Temperature

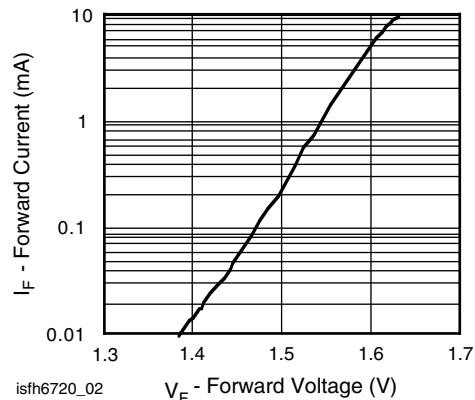


Fig. 2 - Typical Input Diode Forward Current vs. Forward Voltage

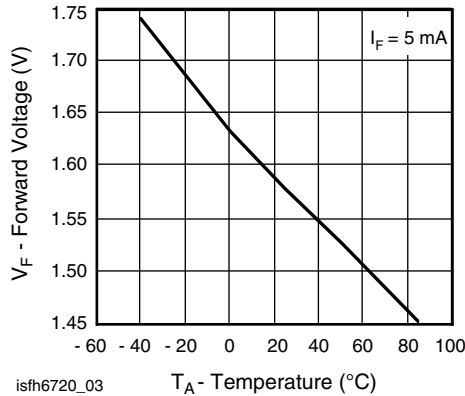


Fig. 3 - Typical Forward Input Voltage vs. Temperature

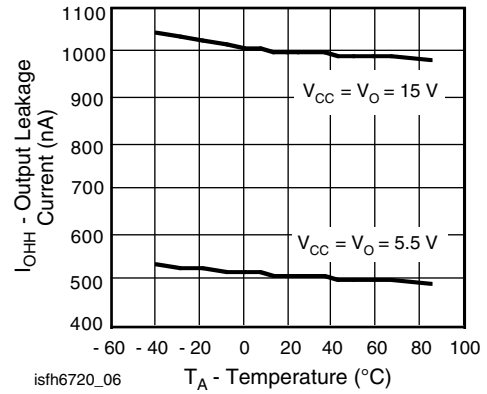


Fig. 6 - Typical Output Leakage Current vs. Temperature

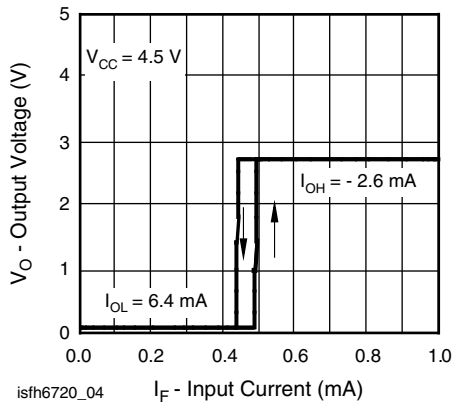


Fig. 4 - Typical Output Voltage vs. Forward Input Current

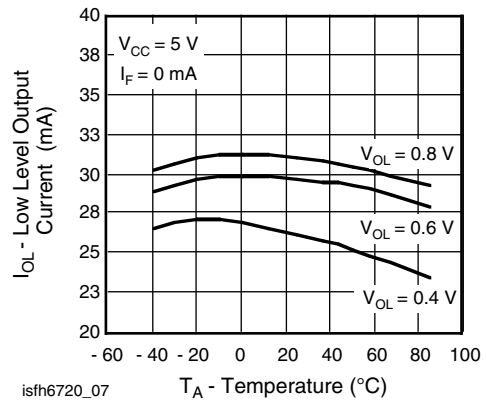


Fig. 7 - Typical Low Level Output Current vs. Temperature

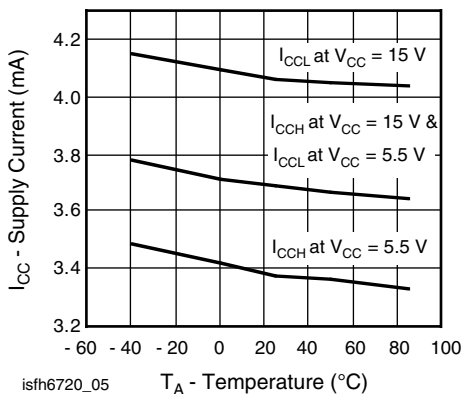


Fig. 5 - Typical Supply Current vs. Temperature

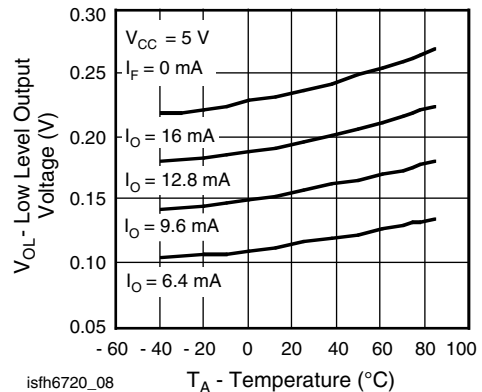


Fig. 8 - Typical Low Level Output Voltage vs. Temperature

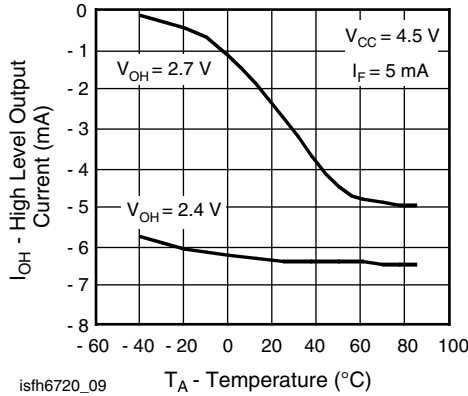


Fig. 9 - Typical High Level Output Current vs. Temperature

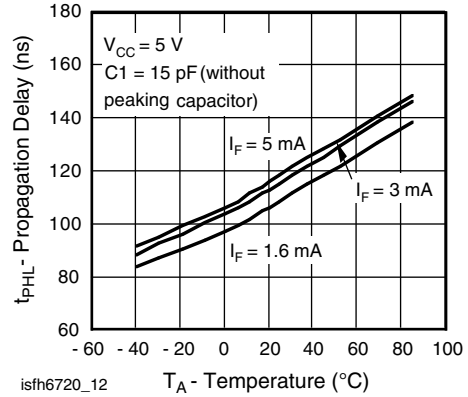


Fig. 12 - Typical Propagation Delays to Logic Low vs. Temperature

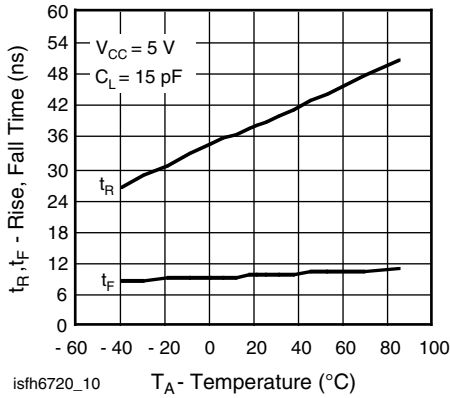


Fig. 10 - Rise and Fall Time vs. Ambient Temperature

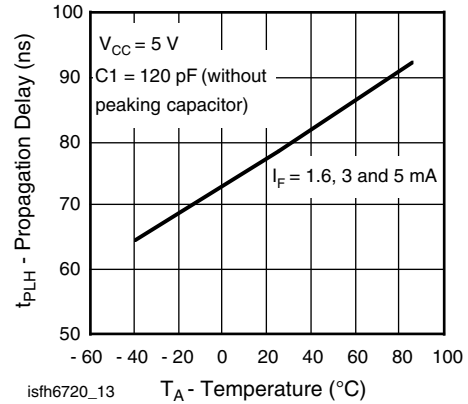


Fig. 13 - Typical Propagation Delays to Logic High vs. Temperature

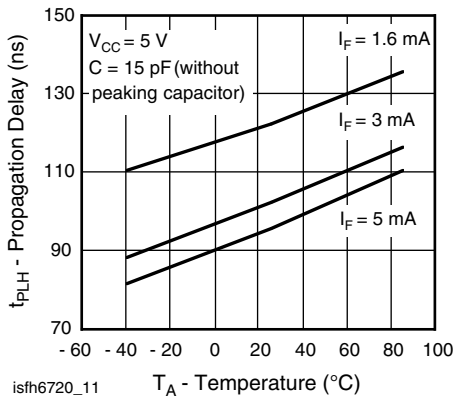


Fig. 11 - Typical Propagation Delays to Logic High vs. Temperature

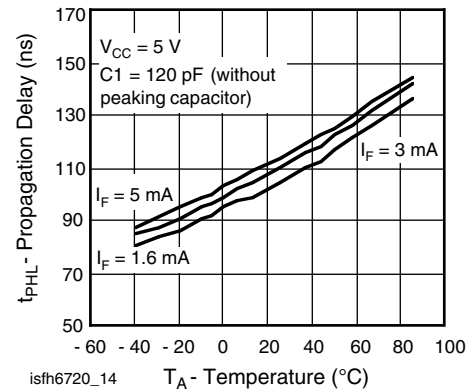


Fig. 14 - Typical Propagation Delays to Logic Low vs. Temperature

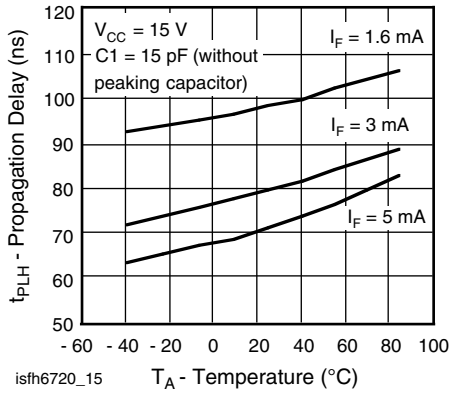


Fig. 15 - Typical Propagation Delays to Logic High vs. Temperature

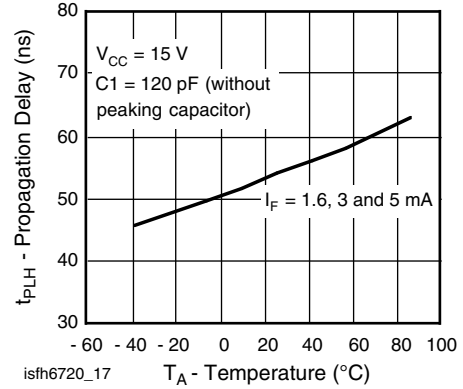


Fig. 17 - Typical Propagation Delays to Logic High vs. Temperature

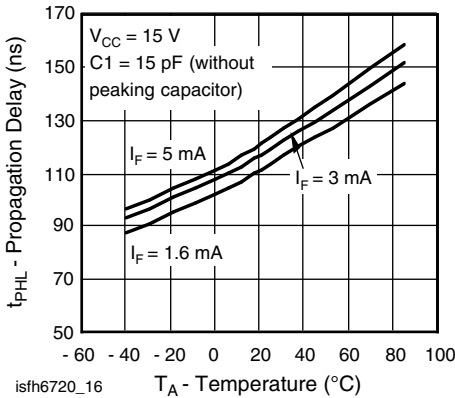


Fig. 16 - Typical Propagation Delays to Logic Low vs. Temperature

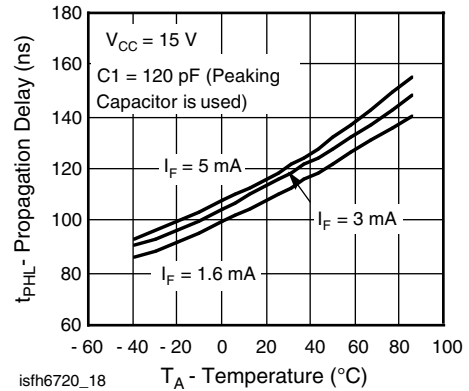


Fig. 18 - Typical Propagation Delays to Logic Low vs. Temperature

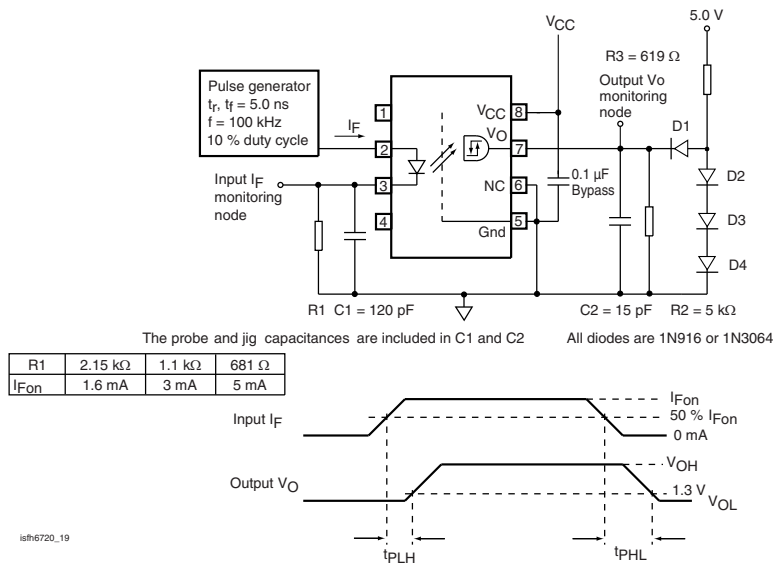


Fig. 19 - Test Circuit for t_{PLH} , t_{PHL} , t_R and t_f

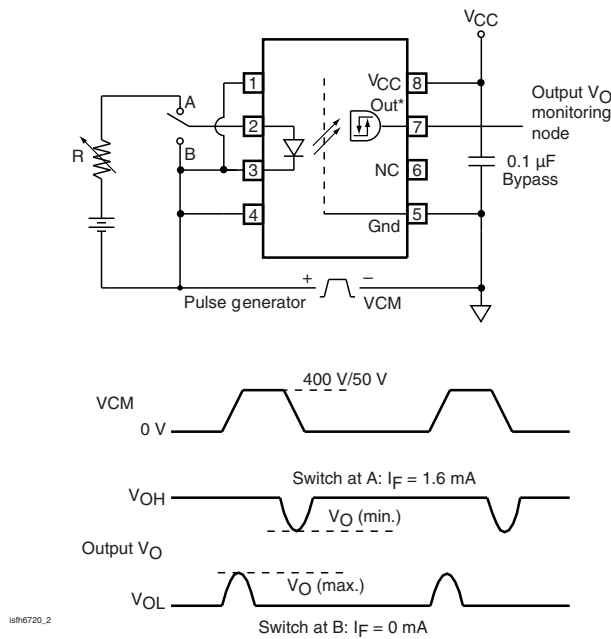


Fig. 20 - Test Circuit for Common Mode Transient Immunity and Typical Waveforms

PACKAGE DIMENSIONS (in millimeters)

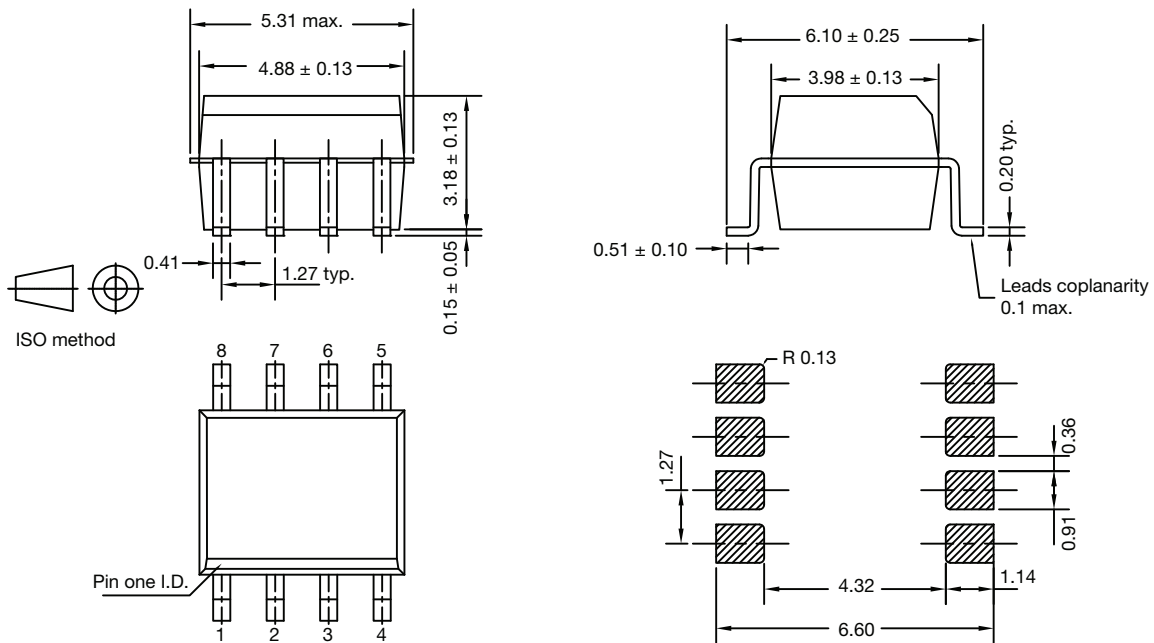


Fig. 21 - Package Dimensions

PACKAGE MARKING



Fig. 22 - SFH6720

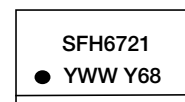
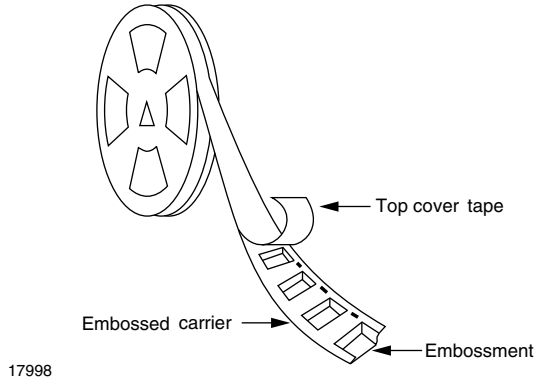


Fig. 23 - SFH6721

Note

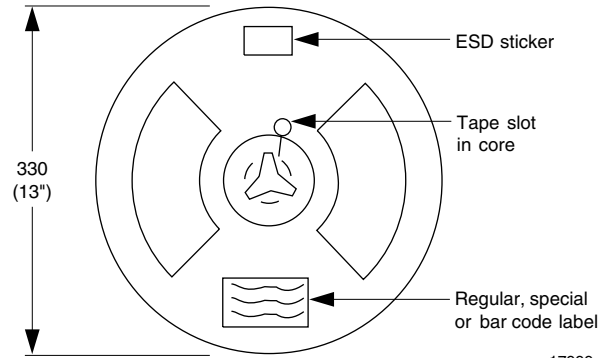
- Tape and reel suffix (T) is not part of the package marking.

PACKAGE INFORMATION (in millimeters)



17998

Fig. 24 - Tape and Reel Shipping Medium



17999

Fig. 25 - Tape and Reel Shipping Medium

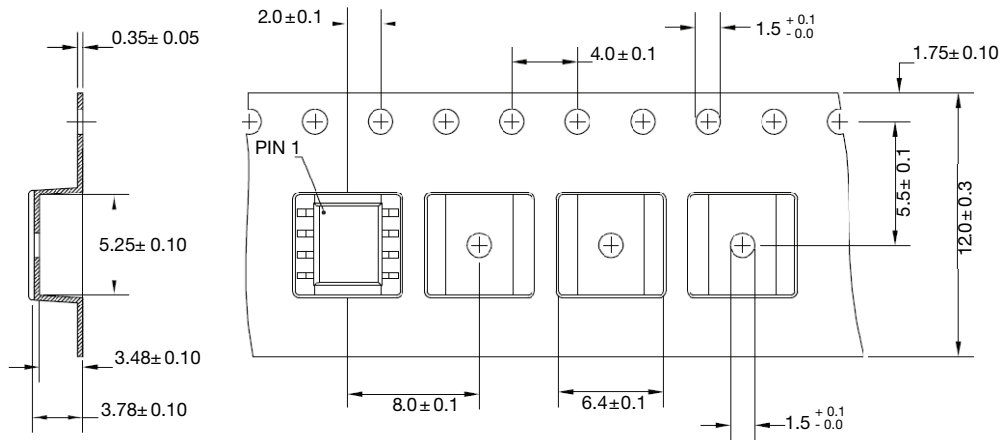
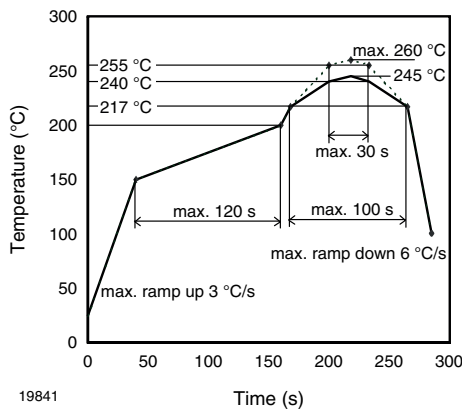


Fig. 26 - Tape and Reel Packing for SOIC (2000 pieces on reel)

SOLDER PROFILES



19841

Fig. 27 - Lead (Pb)-free Reflow Solder Profile According to J-STD-020 for SMD Devices

HANDLING AND STORAGE CONDITIONS

ESD level: HBM class 2

Floor life: unlimited

Conditions: $T_{amb} < 30\text{ }^{\circ}\text{C}$, $RH < 85\%$

Moisture sensitivity level 1, according to J-STD-020



Disclaimer

ALL PRODUCT, PRODUCT SPECIFICATIONS AND DATA ARE SUBJECT TO CHANGE WITHOUT NOTICE TO IMPROVE RELIABILITY, FUNCTION OR DESIGN OR OTHERWISE.

Vishay Intertechnology, Inc., its affiliates, agents, and employees, and all persons acting on its or their behalf (collectively, "Vishay"), disclaim any and all liability for any errors, inaccuracies or incompleteness contained in any datasheet or in any other disclosure relating to any product.

Vishay makes no warranty, representation or guarantee regarding the suitability of the products for any particular purpose or the continuing production of any product. To the maximum extent permitted by applicable law, Vishay disclaims (i) any and all liability arising out of the application or use of any product, (ii) any and all liability, including without limitation special, consequential or incidental damages, and (iii) any and all implied warranties, including warranties of fitness for particular purpose, non-infringement and merchantability.

Statements regarding the suitability of products for certain types of applications are based on Vishay's knowledge of typical requirements that are often placed on Vishay products in generic applications. Such statements are not binding statements about the suitability of products for a particular application. It is the customer's responsibility to validate that a particular product with the properties described in the product specification is suitable for use in a particular application. Parameters provided in datasheets and/or specifications may vary in different applications and performance may vary over time. All operating parameters, including typical parameters, must be validated for each customer application by the customer's technical experts. Product specifications do not expand or otherwise modify Vishay's terms and conditions of purchase, including but not limited to the warranty expressed therein.

Except as expressly indicated in writing, Vishay products are not designed for use in medical, life-saving, or life-sustaining applications or for any other application in which the failure of the Vishay product could result in personal injury or death. Customers using or selling Vishay products not expressly indicated for use in such applications do so at their own risk. Please contact authorized Vishay personnel to obtain written terms and conditions regarding products designed for such applications.

No license, express or implied, by estoppel or otherwise, to any intellectual property rights is granted by this document or by any conduct of Vishay. Product names and markings noted herein may be trademarks of their respective owners.

Material Category Policy

Vishay Intertechnology, Inc. hereby certifies that all its products that are identified as RoHS-Compliant fulfill the definitions and restrictions defined under Directive 2011/65/EU of The European Parliament and of the Council of June 8, 2011 on the restriction of the use of certain hazardous substances in electrical and electronic equipment (EEE) - recast, unless otherwise specified as non-compliant.

Please note that some Vishay documentation may still make reference to RoHS Directive 2002/95/EC. We confirm that all the products identified as being compliant to Directive 2002/95/EC conform to Directive 2011/65/EU.

Vishay Intertechnology, Inc. hereby certifies that all its products that are identified as Halogen-Free follow Halogen-Free requirements as per JEDEC JS709A standards. Please note that some Vishay documentation may still make reference to the IEC 61249-2-21 definition. We confirm that all the products identified as being compliant to IEC 61249-2-21 conform to JEDEC JS709A standards.

单击下面可查看定价，库存，交付和生命周期等信息

[>>Vishay\(威世\)](#)