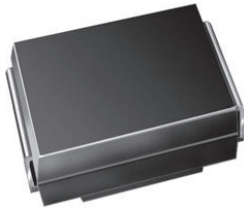

Surface-Mount Ultrafast Plastic Rectifier

SMB (DO-214AA)

 Cathode  Anode 

LINKS TO ADDITIONAL RESOURCES

[3D Models](#)

PRIMARY CHARACTERISTICS

| | |
|-----------------------|----------------|
| $I_{F(AV)}$ | 1.0 A |
| V_{RRM} | 400 V, 600 V |
| I_{FSM} | 35 A |
| t_{rr} | 50 ns |
| V_F | 1.05 V |
| $T_J \text{ max.}$ | 175 °C |
| Package | SMB (DO-214AA) |
| Circuit configuration | Single |

FEATURES

- Glass passivated pellet chip junction
- Ideal for automated placement
- Ultrafast reverse recovery time
- Low switching losses, high efficiency
- High forward surge capability
- Meets MSL level 1, per J-STD-020, LF maximum peak of 260 °C
- Material categorization: for definitions of compliance please see www.vishay.com/doc?99912

RoHS
 COMPLIANT
 HALOGEN
FREE

TYPICAL APPLICATIONS

For use in high frequency rectification and freewheeling application in switching mode converters and inverters for consumer, computer, and telecommunication.

MECHANICAL DATA

Case: SMB (DO-214AA)

Molding compound meets UL 94 V-0 flammability rating
 Base P/N-M3 - halogen-free, RoHS-compliant, and commercial grade

Terminals: matte tin plated leads, solderable per J-STD-002 and JESD 22-B102

M3 suffix meets JESD 201 class 2 whisker test

Polarity: color band denotes cathode end

MAXIMUM RATINGS ($T_A = 25\text{ °C}$ unless otherwise noted)

| PARAMETER | SYMBOL | MURS140 | MURS160 | UNIT |
|--|-----------------------|-------------|---------|------|
| Device marking code | | MG | MJ | |
| Maximum repetitive peak reverse voltage | V_{RRM} | 400 | 600 | V |
| Working peak reverse voltage | V_{RWM} | 400 | 600 | V |
| Maximum DC blocking voltage | V_{DC} | 400 | 600 | V |
| Maximum average forward rectified current at (fig. 1) | $T_L = 150\text{ °C}$ | 1.0 | | A |
| | $T_L = 125\text{ °C}$ | 2.0 | | |
| Peak forward surge current 8.3 ms single half sine-wave superimposed on rated load | I_{FSM} | 35 | | A |
| Operating junction and storage temperature range | T_J, T_{STG} | -65 to +175 | | °C |



| ELECTRICAL CHARACTERISTICS ($T_A = 25\text{ }^\circ\text{C}$ unless otherwise noted) | | | | | |
|--|--|-----------------------------------|-------------|---------|---------------|
| PARAMETER | TEST CONDITIONS | SYMBOL | MURS140 | MURS160 | UNIT |
| Maximum instantaneous forward voltage | $I_F = 1.0\text{ A}$ | $T_J = 25\text{ }^\circ\text{C}$ | $V_F^{(1)}$ | 1.25 | V |
| | | $T_J = 150\text{ }^\circ\text{C}$ | | 1.05 | |
| Maximum instantaneous reverse current at rated DC blocking voltage | | $T_J = 25\text{ }^\circ\text{C}$ | $I_R^{(1)}$ | 5.0 | μA |
| | | $T_J = 150\text{ }^\circ\text{C}$ | | 150 | |
| Maximum reverse recovery time | $I_F = 0.5\text{ A}, I_R = 1.0\text{ A}, I_{rr} = 0.25\text{ A}$ | | t_{rr} | 50 | ns |
| | $I_F = 1.0\text{ A}, dI/dt = 50\text{ A}/\mu\text{s}, V_R = 30\text{ V}, I_{rr} = 10\% I_{RM}$ | | | 75 | |
| Maximum forward recovery time | $I_F = 1.0\text{ A}, dI/dt = 100\text{ A}/\mu\text{s},$ recovery to 1.0 V | | t_{fr} | 50 | ns |

Note

⁽¹⁾ Pulse test: $t_p = 300\text{ }\mu\text{s}$ pulse, duty cycle $\leq 2\%$

| THERMAL CHARACTERISTICS ($T_A = 25\text{ }^\circ\text{C}$ unless otherwise noted) | | | | |
|---|-----------------|---------|---------|---------------------------|
| PARAMETER | SYMBOL | MURS140 | MURS160 | UNIT |
| Typical thermal resistance, junction to lead | $R_{\theta JL}$ | 13 | | $^\circ\text{C}/\text{W}$ |

| ORDERING INFORMATION (Example) | | | | |
|---------------------------------------|-----------------|------------------------|---------------|------------------------------------|
| PREFERRED P/N | UNIT WEIGHT (g) | PREFERRED PACKAGE CODE | BASE QUANTITY | DELIVERY MODE |
| MURS160-M3/52T | 0.096 | 52T | 750 | 7" diameter plastic tape and reel |
| MURS160-M3/5BT | 0.096 | 5BT | 3200 | 13" diameter plastic tape and reel |

RATINGS AND CHARACTERISTICS CURVES ($T_A = 25\text{ }^\circ\text{C}$ unless otherwise noted)

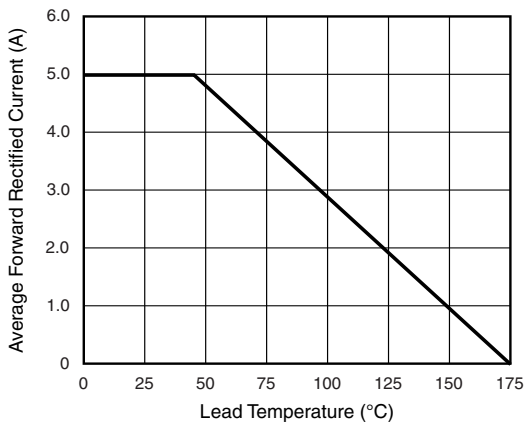

Fig. 1 - Forward Current Derating Curve

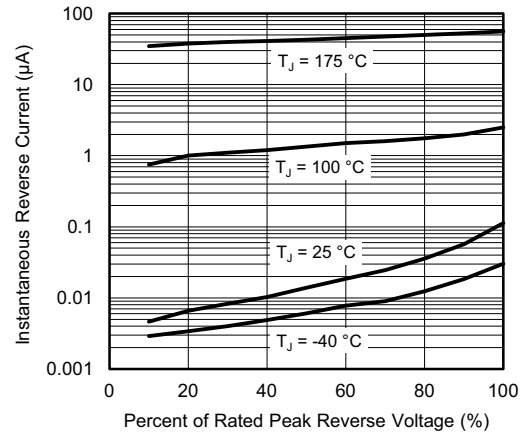

Fig. 4 - Typical Reverse Leakage Characteristics

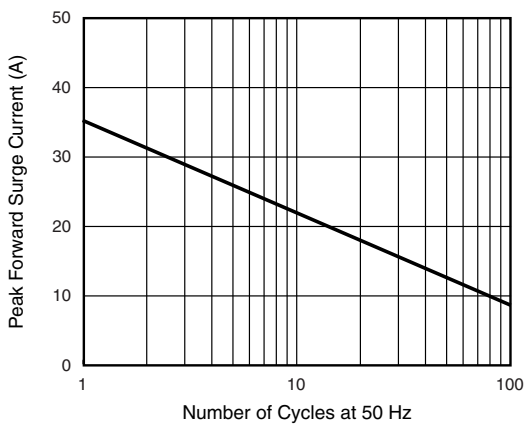

Fig. 2 - Maximum Non-Repetitive Peak Forward Surge Current

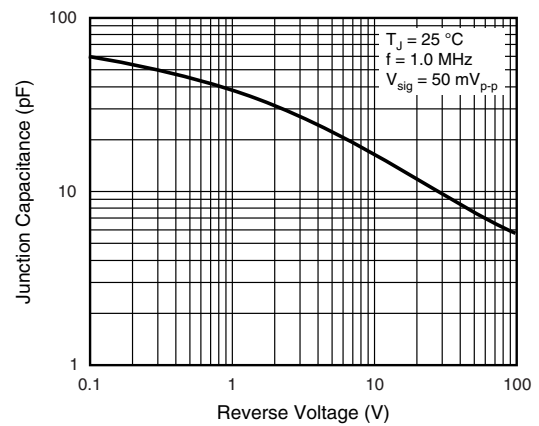

Fig. 5 - Typical Junction Capacitance

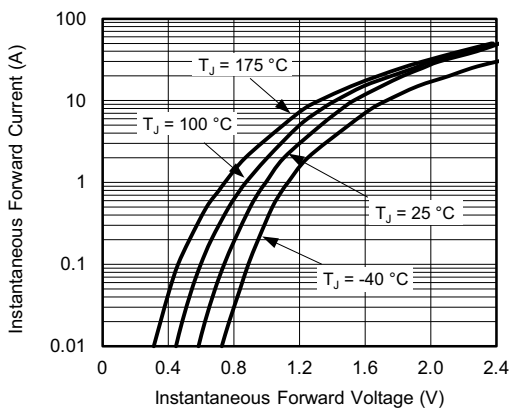
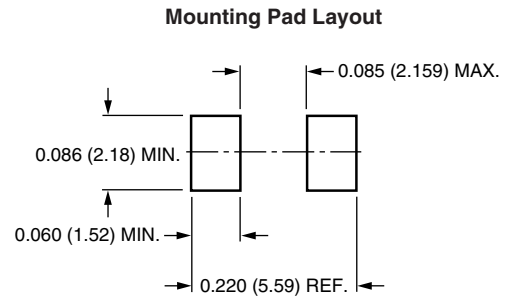
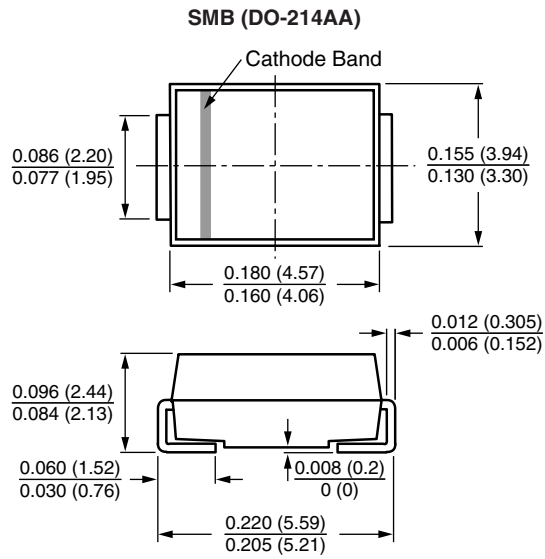

Fig. 3 - Typical Instantaneous Forward Characteristics



PACKAGE OUTLINE DIMENSIONS in inches (millimeters)





Disclaimer

ALL PRODUCT, PRODUCT SPECIFICATIONS AND DATA ARE SUBJECT TO CHANGE WITHOUT NOTICE TO IMPROVE RELIABILITY, FUNCTION OR DESIGN OR OTHERWISE.

Vishay Intertechnology, Inc., its affiliates, agents, and employees, and all persons acting on its or their behalf (collectively, "Vishay"), disclaim any and all liability for any errors, inaccuracies or incompleteness contained in any datasheet or in any other disclosure relating to any product.

Vishay makes no warranty, representation or guarantee regarding the suitability of the products for any particular purpose or the continuing production of any product. To the maximum extent permitted by applicable law, Vishay disclaims (i) any and all liability arising out of the application or use of any product, (ii) any and all liability, including without limitation special, consequential or incidental damages, and (iii) any and all implied warranties, including warranties of fitness for particular purpose, non-infringement and merchantability.

Statements regarding the suitability of products for certain types of applications are based on Vishay's knowledge of typical requirements that are often placed on Vishay products in generic applications. Such statements are not binding statements about the suitability of products for a particular application. It is the customer's responsibility to validate that a particular product with the properties described in the product specification is suitable for use in a particular application. Parameters provided in datasheets and / or specifications may vary in different applications and performance may vary over time. All operating parameters, including typical parameters, must be validated for each customer application by the customer's technical experts. Product specifications do not expand or otherwise modify Vishay's terms and conditions of purchase, including but not limited to the warranty expressed therein.

Hyperlinks included in this datasheet may direct users to third-party websites. These links are provided as a convenience and for informational purposes only. Inclusion of these hyperlinks does not constitute an endorsement or an approval by Vishay of any of the products, services or opinions of the corporation, organization or individual associated with the third-party website. Vishay disclaims any and all liability and bears no responsibility for the accuracy, legality or content of the third-party website or for that of subsequent links.

Except as expressly indicated in writing, Vishay products are not designed for use in medical, life-saving, or life-sustaining applications or for any other application in which the failure of the Vishay product could result in personal injury or death. Customers using or selling Vishay products not expressly indicated for use in such applications do so at their own risk. Please contact authorized Vishay personnel to obtain written terms and conditions regarding products designed for such applications.

No license, express or implied, by estoppel or otherwise, to any intellectual property rights is granted by this document or by any conduct of Vishay. Product names and markings noted herein may be trademarks of their respective owners.

单击下面可查看定价，库存，交付和生命周期等信息

[>>Vishay\(威世\)](#)