

THREE PHASE BRIDGE

Power Module

Features

- Low V_F
- Low profile package
- Direct Mounting to heatsink
- Flat-Pin/ Round-Pin versions with PCB solderable terminals
- Low junction-to-case Thermal Resistance
- 3500 V_{RMS} insulation voltage
- UL approval pending

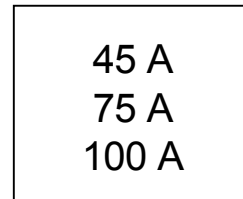

Applications: Power conversion machines

- Welding
- UPS
- SMPS
- Motor Drives
- General Purpose & Heavy Duty Applications

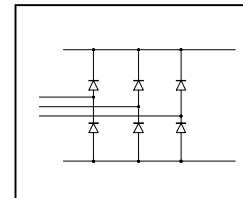

Description

A range of extremely compact three-phase rectifier bridges offering efficient and reliable operation. The low profile package has been specifically conceived to maximize space saving and optimize the electrical layout of the application specific Power Supplies.

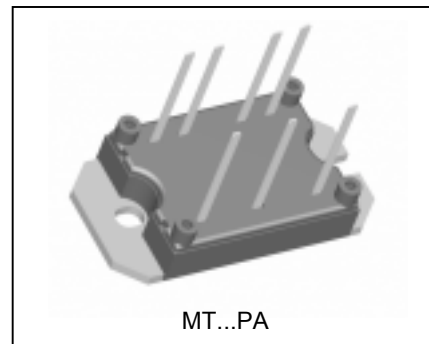

Major Ratings and Characteristics

| Parameters | 40MT | 70MT | 100MT | Units |
|-----------------|-------------|------|-------|---------|
| I_O | 45 | 75 | 100 | A |
| @ T_C | 100 | 80 | 80 | °C |
| I_{FSM} | 270 | 380 | 450 | A |
| @ 50Hz | 280 | 398 | 470 | |
| @ 60Hz | 365 | 724 | 1013 | A^2s |
| I^2t | 325 | 660 | 920 | |
| @ 50Hz | 3650 | 7240 | 10130 | A^2Vs |
| @ 60Hz | | | | |
| V_{RRM} | 1400 & 1600 | | | V |
| T_{STG} range | -40 to 125 | | | °C |
| T_J range | -40 to 150 | | | |

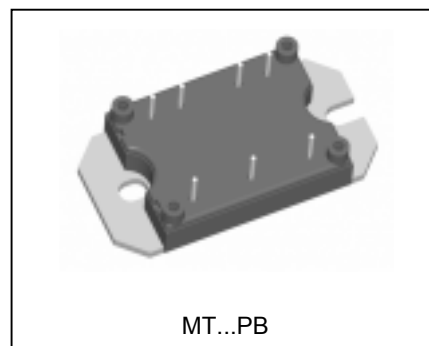

ELECTRICAL SPECIFICATIONS

Voltage Ratings

| Type number | Voltage Code reverse voltage V | V_{RRM} , maximum repetitive peak reverse voltage V | V_{RSM} , maximum non-repetitive peak V | I_{RRM} max. @ $T_J = 150^\circ\text{C}$ mA |
|-----------------|-----------------------------------|--|--|---|
| 40-70-100MT140P | 140 | 1400 | 1500 | 5 |
| 40-70-100MT160P | 160 | 1600 | 1700 | |

Forward Conduction

| Parameter | 40MT | 70MT | 100MT | Units | Conditions |
|--|------------------------|------------------------|-------------------------|-------------------|--|
| I_O Maximum DC output current @ Case temperature | 45 | 75 | 100 | A | 120° Rect conduction angle |
| | 100 | 80 | 80 | °C | |
| I_{FSM} Maximum peak, one-cycle forward, non-repetitive on state surge current | 270 | 380 | 450 | A | t = 10ms No voltage reappplied |
| | 280 | 398 | 470 | | t = 8.3ms |
| | 225 | 320 | 380 | | t = 10ms 100% V_{RRM} reappplied |
| | 240 | 335 | 400 | | t = 8.3ms |
| I^2t Maximum I^2t for fusing | 365 | 724 | 1013 | A ² s | t = 10ms No voltage reappplied |
| | 325 | 660 | 920 | | t = 8.3ms |
| | 253 | 512 | 600 | | t = 10ms 100% V_{RRM} reappplied |
| | 240 | 467 | 665 | | t = 8.3ms |
| $I^2\sqrt{t}$ Maximum $I^2\sqrt{t}$ for fusing | 3650 | 7240 | 10130 | A ² √s | t = 0.1 to 10ms, no voltage reappplied |
| $V_{F(TO)}$ Value of threshold voltage | 0.78 | 0.82 | 0.75 | V | @ T_J max. |
| r_t Slope resistance | 14.8 | 9.5 | 8.1 | mΩ | |
| V_{FM} Maximum forward voltage drop | 1.45 $I_{pk} = 40A$ | 1.45 $I_{pk} = 70A$ | 1.51 $I_{pk} = 100A$ | V | $T_J = 25^\circ\text{C}$ $t_p = 400\mu\text{s}$ single junction |

Insulation Table

| Parameter | 40MT | 70MT | 100MT | Units | Conditions |
|----------------------------------|------|------|-------|-------|---|
| V_{INS} RMS insulation voltage | 3500 | | | V | $T_J = 25^\circ\text{C}$ all terminal shorted f = 50Hz, t = 1s |

Thermal and Mechanical Specifications

| Parameter | 40MT | 70MT | 100MT | Units | Conditions |
|--|-------------|------|-------|-------|--|
| T _J Maximum junction operating temperature range | - 40 to 150 | | | °C | |
| T _{stg} Maximum storage temperature range | -40 to 125 | | | °C | |
| R _{thJC} Maximum thermal resistance, junction to case | 0.27 | 0.23 | 0.19 | K/W | DC operation per module |
| | 1.6 | 1.38 | 1.14 | | DC operation per junction |
| | 0.38 | 0.29 | 0.22 | | 120° Rect conduction angle per module |
| | 2.25 | 1.76 | 1.29 | | 120° Rect conduction angle per junction |
| R _{thCS} Maximum thermal resistance, case to heatsink | 0.1 | | | K/W | Per module. Mounting surface smooth, flat and greased. Heatsink compound thermal conductivity = 0.42W/mK |
| T Mounting torque ± 10% to heatsink | 4 | | | Nm | A mounting compound is recommended and the torque should be rechecked after a period of 3 hours to allow for the spread of the compound. |
| wt Approximate weight | 65 | | | g | Lubricated threads. |

Clearance and Creepage Distances

| Parameter | MT...PA | MT...PB | Units |
|---|---------|---------|-------|
| Clearance (external shortest distance in air between terminals which are not internally short circuited together) | 10.9 | 12.3 | mm |
| Creepage distance (shortest distance along external surface of the insulating material between terminals which are not internally short circuited together) | 10.9 | 12.3 | mm |

Ordering Information Table

Device Code

| | | | | | |
|----|---|----|-----|---|---|
| 10 | 0 | MT | 160 | P | B |
| ① | ② | ③ | ④ | ⑤ | |

1 - Current rating code

2 - Circuit configuration code: 0 = 3-Phase Rectifier Bridge

3 - Essential part number

4 - Voltage code: code x 10 = V_{RRM} (See Voltage Ratings table)

5 - Pinout code:

4 = 45A
 7 = 75A
 10 = 100A

A = Flat pins
 B = Round pins

MTP 3-Phase Rectifier Series

Bulletin I27145 rev. B 06/02

International
IR Rectifier

Outline Table

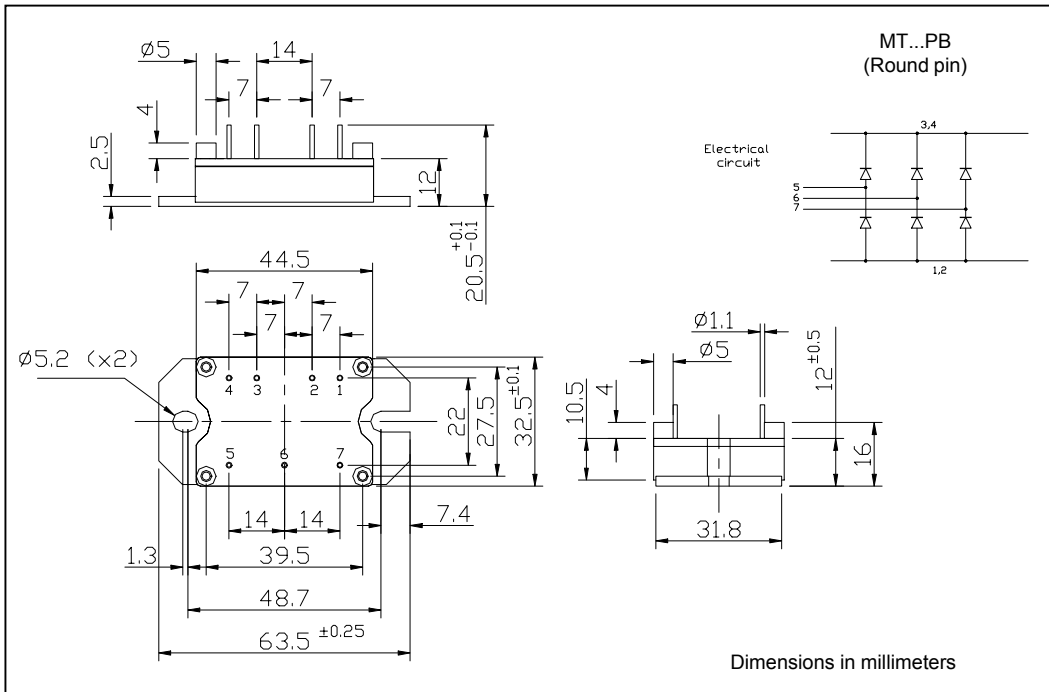
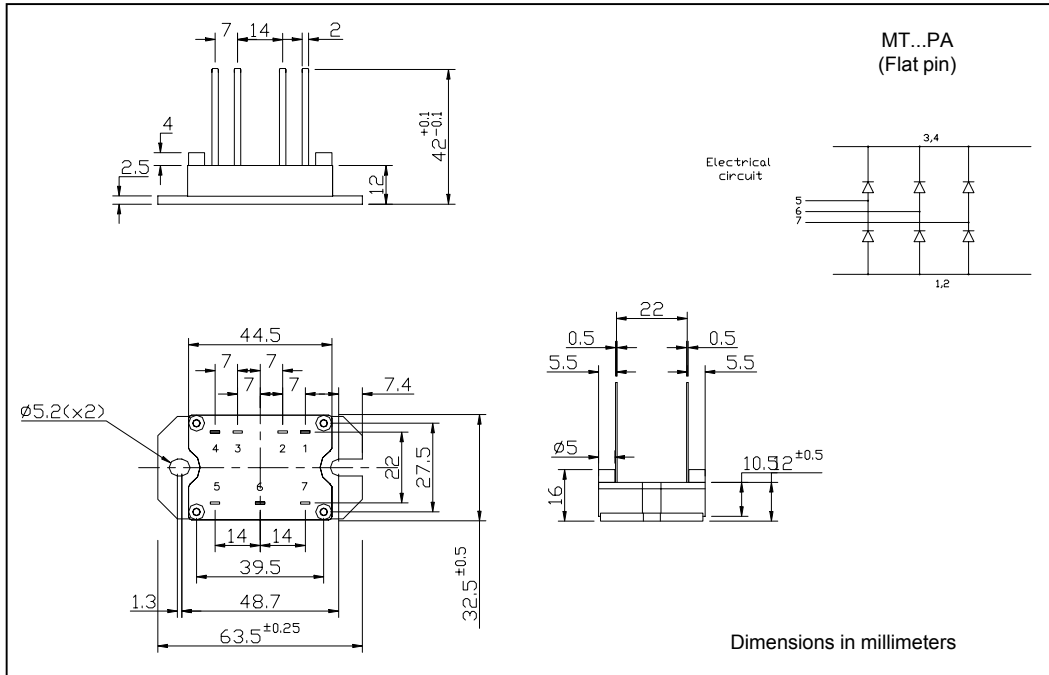

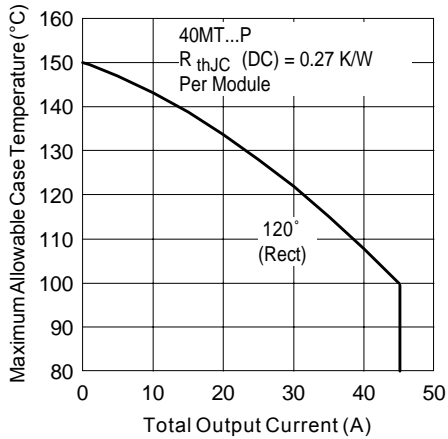

Fig. 1 - Current Rating Characteristics

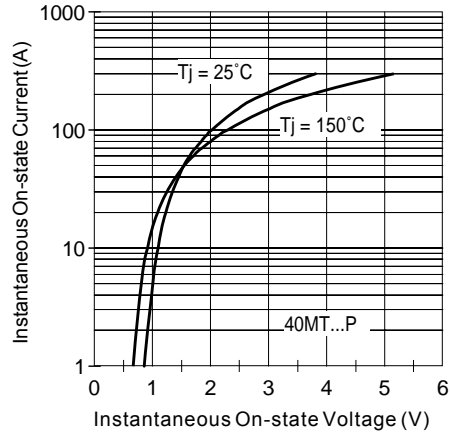

Fig. 2 - On-state Voltage Drop Characteristics

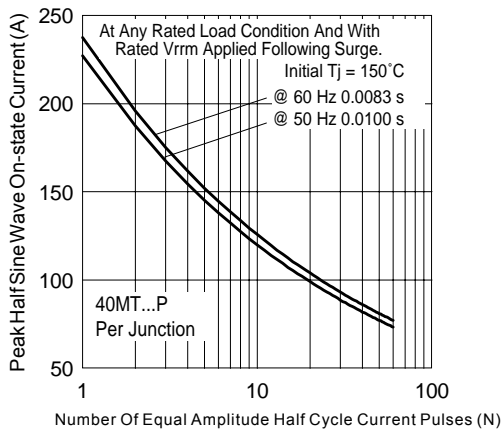

Fig. 3 - Maximum Non-Repetitive Surge Current

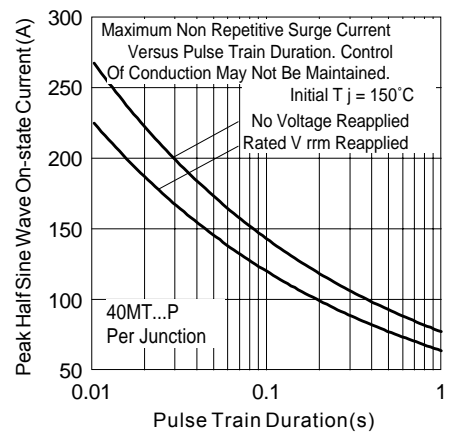

Fig. 4 - Maximum Non-Repetitive Surge Current

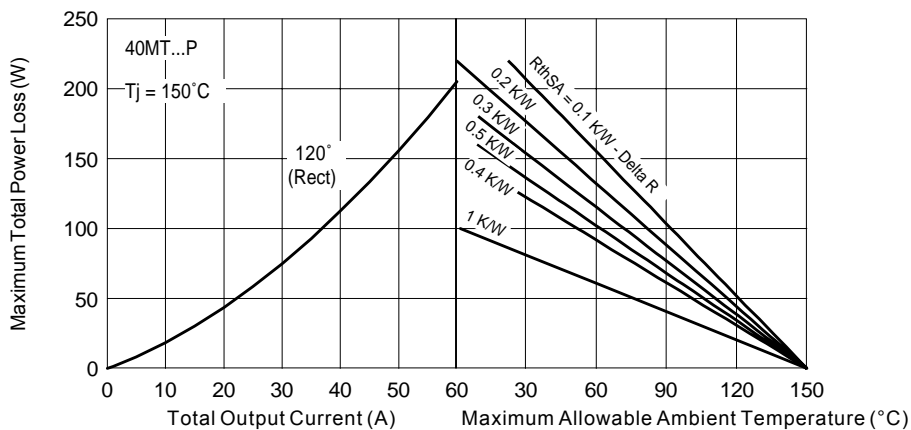

Fig. 5 - Current Rating Nomogram (1 Module Per Heatsink)

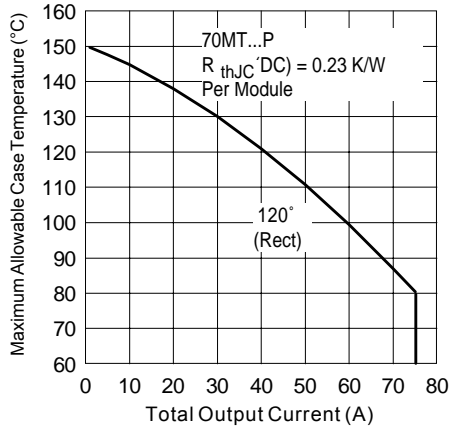

Fig. 6 - Current Rating Characteristics

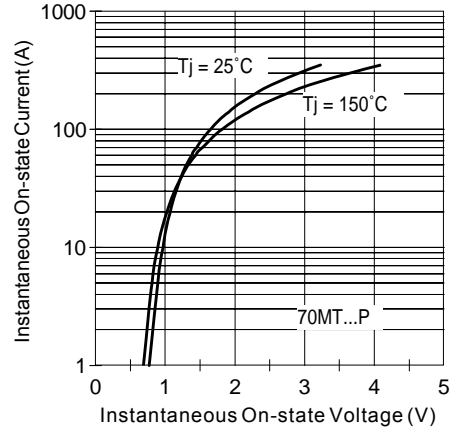

Fig. 7 - On-state Voltage Drop Characteristics

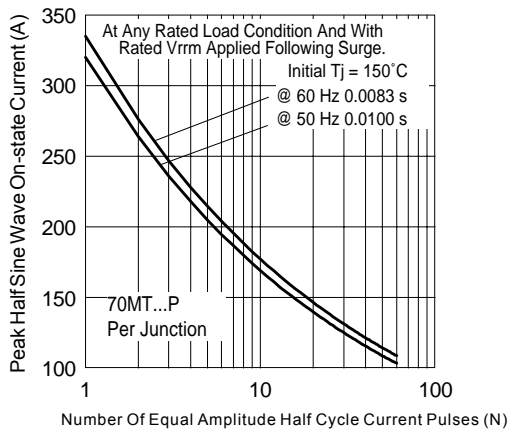

Fig. 8 - Maximum Non-Repetitive Surge Current

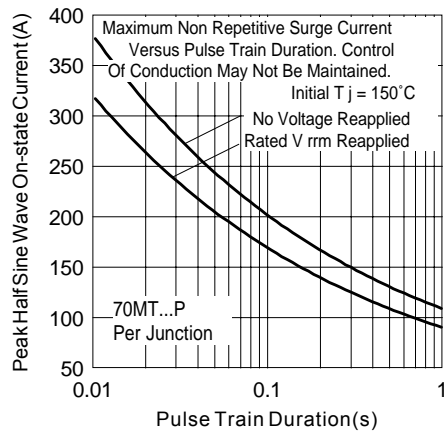

Fig. 9 - Maximum Non-Repetitive Surge Current

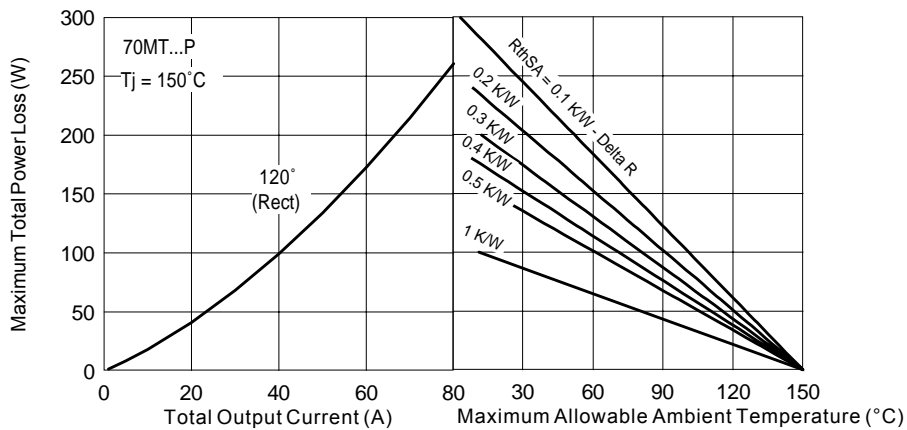

Fig. 10 - Current Rating Nomogram (1 Module Per Heatsink)

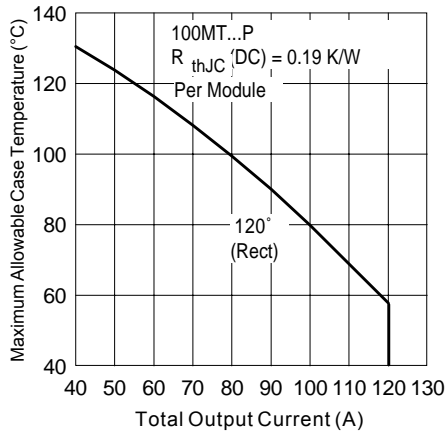

Fig. 11 - Current Rating Characteristics

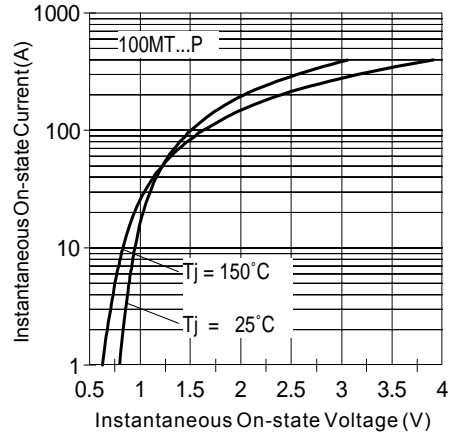

Fig. 12 - On-state Voltage Drop Characteristics

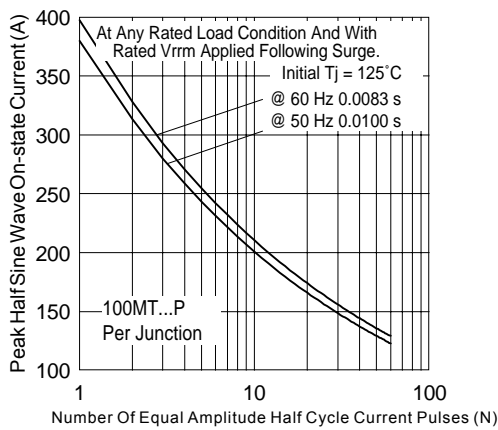

Fig. 13 - Maximum Non-Repetitive Surge Current

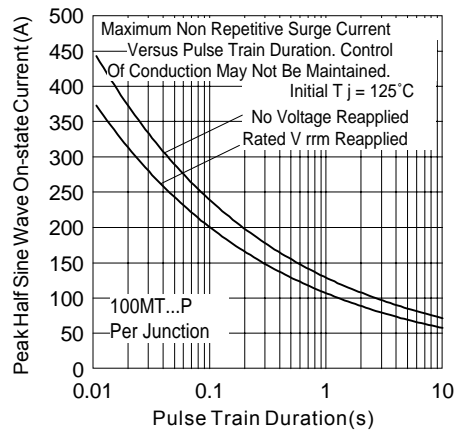

Fig. 14 - Maximum Non-Repetitive Surge Current

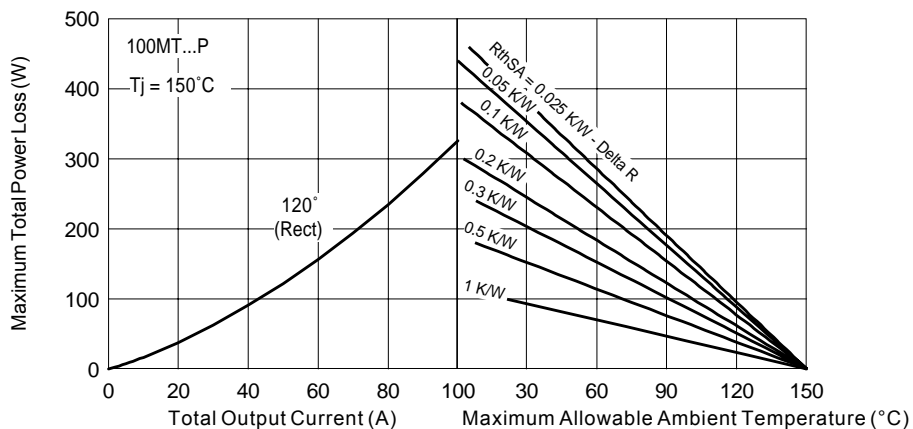

Fig. 15 - Current Rating Nomogram (1 Module Per Heatsink)

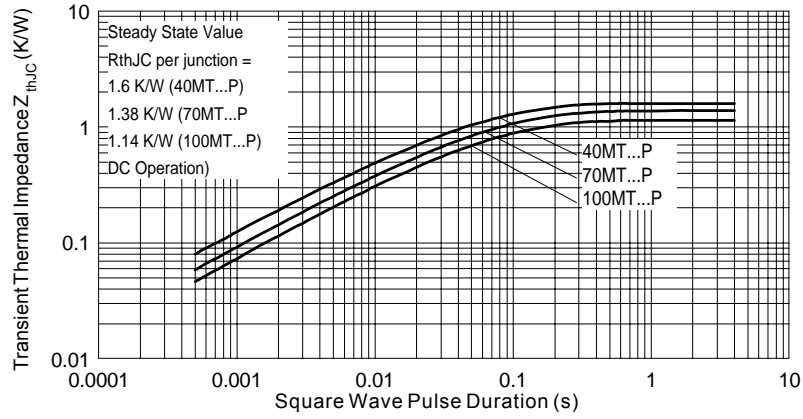

Fig. 16 - Thermal Impedance Z_{thJC} Characteristics

Data and specifications subject to change without notice.
This product has been designed and qualified for Industrial Level.
Qualification Standards can be found on IR's Web site.

单击下面可查看定价，库存，交付和生命周期等信息

[>>Vishay\(威世\)](#)