



# Fast Recovery Diodes (Hockey PUK Version), 350 A



A-PUK (DO-200AA)

### FEATURES

- High power fast recovery diode series
- 1.0  $\mu$ s to 2.0  $\mu$ s recovery time
- High voltage ratings up to 2500 V
- High current capability
- Optimized turn-on and turn-off characteristics
- Low forward recovery
- Fast and soft reverse recovery
- Press PUK encapsulation
- Case style conform to JEDEC® A-PUK (DO-200AA)
- Maximum junction temperature 125 °C
- Material categorization: for definitions of compliance please see [www.vishay.com/doc?99912](http://www.vishay.com/doc?99912)



RoHS  
COMPLIANT

| PRIMARY CHARACTERISTICS |                  |
|-------------------------|------------------|
| $I_{F(AV)}$             | 350 A            |
| Package                 | A-PUK (DO-200AA) |
| Circuit configuration   | Single           |

### TYPICAL APPLICATIONS

- Snubber diode for GTO
- High voltage freewheeling diode
- Fast recovery rectifier applications

| MAJOR RATINGS AND CHARACTERISTICS |                 |              |              |              |                   |
|-----------------------------------|-----------------|--------------|--------------|--------------|-------------------|
| PARAMETER                         | TEST CONDITIONS | VS-SD303C..C |              |              | UNITS             |
|                                   |                 | S10          | S15          | S20          |                   |
| $I_{F(AV)}$                       |                 | 350          | 350          | 350          | A                 |
|                                   | $T_{hs}$        | 55           | 55           | 55           | °C                |
| $I_{F(RMS)}$                      |                 | 550          | 550          | 550          | A                 |
|                                   | $T_{hs}$        | 25           | 25           | 25           | °C                |
| $I_{FSM}$                         | 50 Hz           | 5770         | 5770         | 5770         | A                 |
|                                   | 60 Hz           | 6040         | 6040         | 6040         |                   |
| $I^2t$                            | 50 Hz           | 166          | 166          | 166          | kA <sup>2</sup> s |
|                                   | 60 Hz           | 152          | 152          | 152          |                   |
| $V_{RRM}$                         | Range           | 400 to 1000  | 1200 to 1600 | 2000 to 2500 | V                 |
| $t_{rr}$                          |                 | 1.0          | 1.5          | 2.0          | $\mu$ s           |
|                                   | $T_J$           | 25           | 25           | 25           | °C                |
| $T_J$                             |                 | -40 to +125  | -40 to +125  | -40 to +125  |                   |

### ELECTRICAL SPECIFICATIONS

| VOLTAGE RATINGS |              |  |  |   |
|-----------------|--------------|--|--|---|
| TYPE NUMBER     | VOLTAGE CODE | $V_{RRM}$ , MAXIMUM REPETITIVE PEAK AND OFF-STATE VOLTAGE<br>V | $V_{RSM}$ , MAXIMUM NON-REPETITIVE PEAK REVERSE VOLTAGE<br>V | $I_{RRM}$ MAXIMUM AT $T_J = 125$ °C<br>mA |
| VS-SD303C..S10C | 04           | 400  | 500  | 35  |
|                 | 08           | 800  | 900  |   |
|                 | 10           | 1000   | 1100   |   |
| VS-SD303C..S15C | 12           | 1200   | 1300   |   |
|                 | 14           | 1400   | 1500   |   |
|                 | 16           | 1600   | 1700   |   |
| VS-SD303C..S20C | 20           | 2000   | 2100   |   |
|                 | 25           | 2500   | 2600   |   |



| FORWARD CONDUCTION                                      |               |   |                       |                         |                    |
|---|---------------|---|-----------------------|-------------------------|--------------------|
| PARAMETER   | SYMBOL        | TEST CONDITIONS   |                       | VALUES                  | UNITS              |
| Maximum average forward current at heatsink temperature | $I_{F(AV)}$   | 180° conduction, half sine wave<br>Double side (single side) cooled                     |                       | 350 (175)               | A                  |
|   |               |   |                       | 55 (75)                 | °C                 |
| Maximum RMS current                                     | $I_{F(RMS)}$  | 25 °C heatsink temperature double side cooled   |                       | 550                     |                    |
| Maximum peak, one-cycle, non-repetitive forward current | $I_{FSM}$     | t = 10 ms<br>t = 8.3 ms   | No voltage reappplied | 5770                    | A                  |
|   |               |   |                       | t = 10 ms<br>t = 8.3 ms |                    |
|   |               | Sinusoidal half wave, initial $T_J = T_J$ maximum                                       | 4850                  |                         |                    |
|   |               |   | 5080                  |                         |                    |
| Maximum $I^2t$ for fusing                               | $I^2t$        | t = 10 ms<br>t = 8.3 ms   | No voltage reappplied | 166                     | kA <sup>2</sup> s  |
|   |               |   |                       | t = 10 ms<br>t = 8.3 ms |                    |
|   |               | 117   |                       |                         |                    |
|   |               | 107   |                       |                         |                    |
| Maximum $I^2\sqrt{t}$ for fusing                        | $I^2\sqrt{t}$ | t = 0.1 to 10 ms, no voltage reappplied   |                       | 1660                    | kA <sup>2</sup> √s |
| Low level value of threshold voltage                    | $V_{F(TO)1}$  | (16.7 % $\times \pi \times I_{F(AV)} < I < \pi \times I_{F(AV)}$ ), $T_J = T_J$ maximum |                       | 1.14                    | V                  |
| High level value of threshold voltage                   | $V_{F(TO)2}$  | (I > $\pi \times I_{F(AV)}$ ), $T_J = T_J$ maximum                                      |                       | 1.63                    |                    |
| Low level of forward slope resistance                   | $r_{f1}$      | (16.7 % $\times \pi \times I_{F(AV)} < I < \pi \times I_{F(AV)}$ ), $T_J = T_J$ maximum |                       | 1.14                    | mW                 |
| High level of forward slope resistance                  | $r_{f2}$      | (I > $\pi \times I_{F(AV)}$ ), $T_J = T_J$ maximum                                      |                       | 0.77                    |                    |
| Maximum forward voltage drop                            | $V_{FM}$      | $I_{pk} = 1100$ A, $T_J = 25$ °C; $t_p = 10$ ms sinusoidal wave                         |                       | 2.26                    | V                  |

| RECOVERY CHARACTERISTICS |                                 |                           |              |           |                                  |               |              |  |
|--------------------------|---------------------------------|---------------------------|--------------|-----------|----------------------------------|---------------|--------------|--|
| CODE                     | MAXIMUM VALUE AT $T_J = 25$ °C  | TEST CONDITIONS           |              |           | TYPICAL VALUES AT $T_J = 125$ °C |               |              |  |
|                          | $t_{rr}$ AT 25 % $I_{RRM}$ (μs) | $I_{pk}$ SQUARE PULSE (A) | dI/dt (A/μs) | $V_r$ (V) | $t_{rr}$ AT 25 % $I_{RRM}$ (μs)  | $Q_{rr}$ (μC) | $I_{rr}$ (A) |  |
| S10                      | 1.0                             | 750                       | 25           | - 30      | 2.4                              | 52            | 33           |  |
| S15                      | 1.5                             |                           |              |           | 2.9                              | 90            | 44           |  |
| S20                      | 2.0                             |                           |              |           | 3.2                              | 107           | 46           |  |

| THERMAL AND MECHANICAL SPECIFICATIONS            |              |   |  |                  |        |
|--|--------------|---|--|------------------|--------|
| PARAMETER  | SYMBOL       | TEST CONDITIONS                               |  | VALUES           | UNITS  |
| Maximum operating temperature range              | $T_J$        |   |  | -40 to 125       | °C     |
| Maximum storage temperature range                | $T_{Stg}$    |   |  | -40 to 150       |        |
| Maximum thermal resistance, junction to heatsink | $R_{thJ-hs}$ | DC operation single side cooled               |  | 0.16             | K/W    |
|  |              | DC operation double side cooled               |  | 0.08             |        |
| Mounting force, ± 10 %                           |              |   |  | 4900 (500)       | N (kg) |
| Approximate weight                               |              |   |  | 70               | g      |
| Case style                                       |              | See dimensions - link at the end of datasheet |  | A-PUK (DO-200AA) |        |

| $\Delta R_{thJ-hs}$ CONDUCTION |                       |             |                        |             |                     |       |
|--------------------------------|-----------------------|-------------|------------------------|-------------|---------------------|-------|
| CONDUCTION ANGLE               | SINUSOIDAL CONDUCTION |             | RECTANGULAR CONDUCTION |             | TEST CONDITIONS     | UNITS |
|                                | SINGLE SIDE           | DOUBLE SIDE | SINGLE SIDE            | DOUBLE SIDE |                     |       |
| 180°                           | 0.010                 | 0.011       | 0.008                  | 0.008       | $T_J = T_J$ maximum | K/W   |
| 120°                           | 0.012                 | 0.013       | 0.013                  | 0.013       |                     |       |
| 90°                            | 0.016                 | 0.016       | 0.018                  | 0.018       |                     |       |
| 60°                            | 0.024                 | 0.024       | 0.025                  | 0.025       |                     |       |
| 30°                            | 0.042                 | 0.042       | 0.042                  | 0.042       |                     |       |

Note

- The table above shows the increment of thermal resistance  $R_{thJ-hs}$  when devices operate at different conduction angles than DC

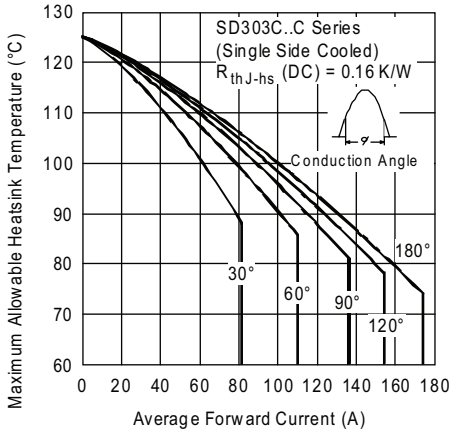

Fig. 1 - Current Ratings Characteristics

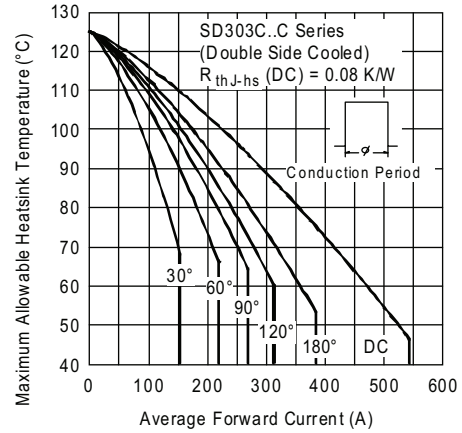

Fig. 4 - Current Ratings Characteristics

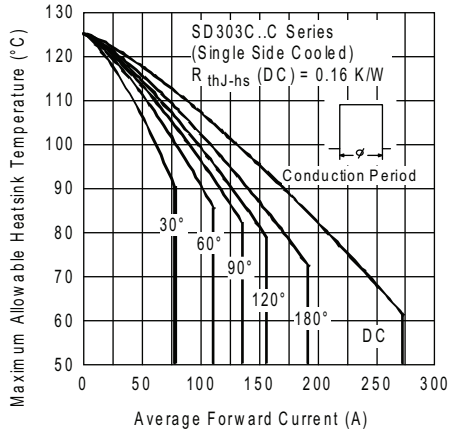

Fig. 2 - Current Ratings Characteristics

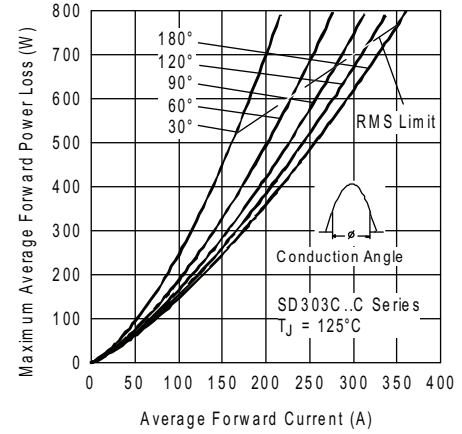

Fig. 5 - Forward Power Loss Characteristics

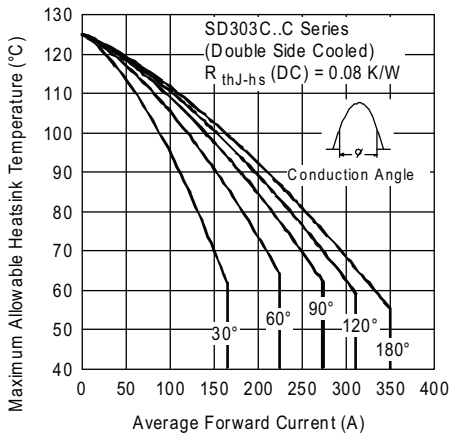

Fig. 3 - Current Ratings Characteristics

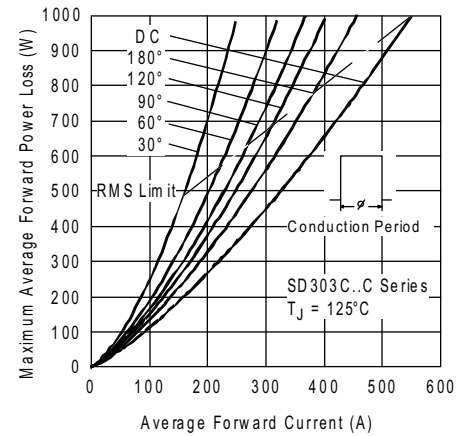

Fig. 6 - Forward Power Loss Characteristics

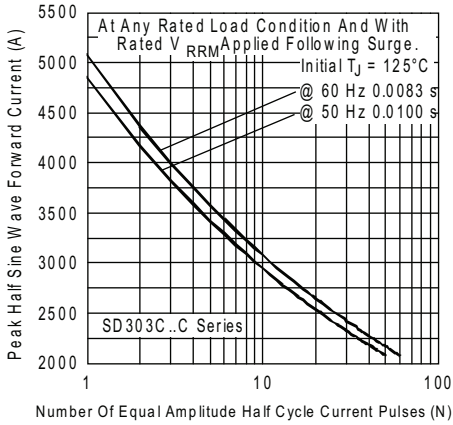

Fig. 7 - Maximum Non-Repetitive Surge Current Single and Double Side Cooled

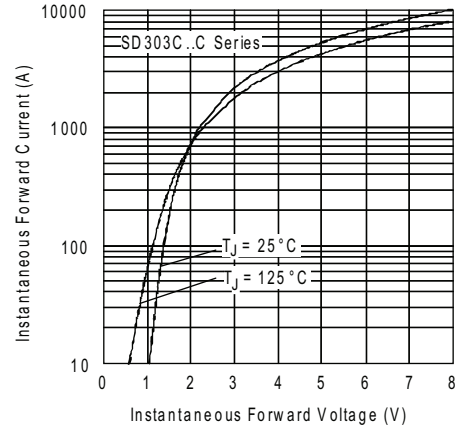

Fig. 9 - Forward Voltage Drop Characteristics

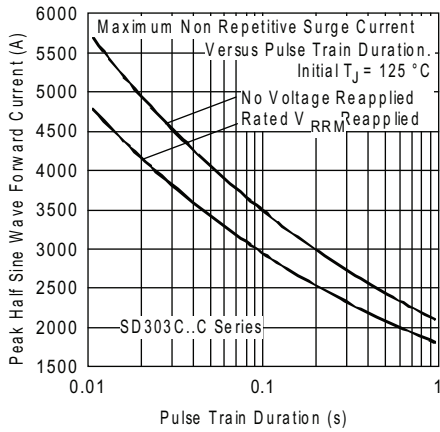

Fig. 8 - Maximum Non-Repetitive Surge Current Single and Double Side Cooled

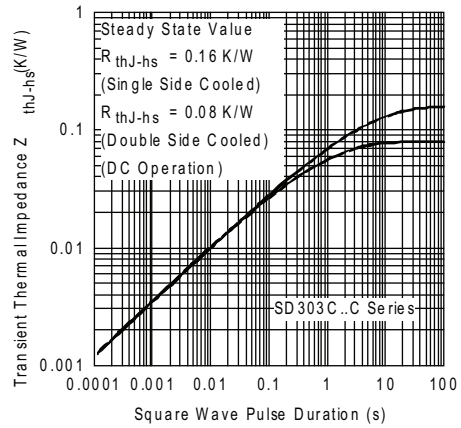

Fig. 10 - Thermal Impedance  $Z_{thj-hs}$  Characteristic

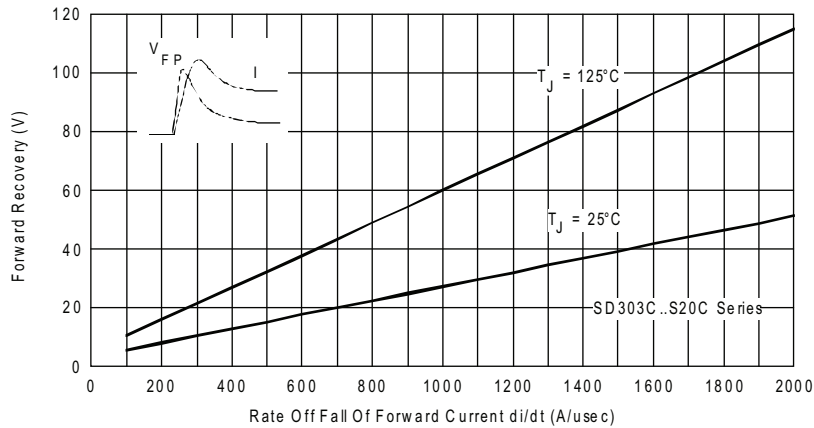

Fig. 11 - Typical Forward Recovery Characteristics

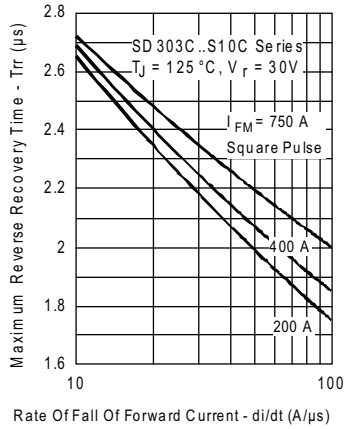

Fig. 12 - Recovery Time Characteristics

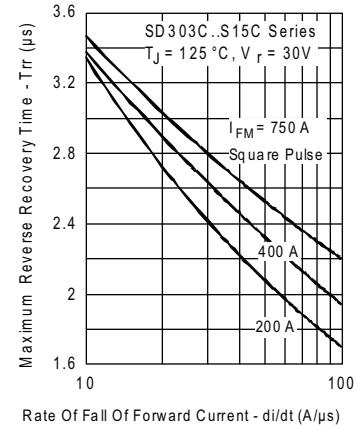

Fig. 15 - Recovery Time Characteristics

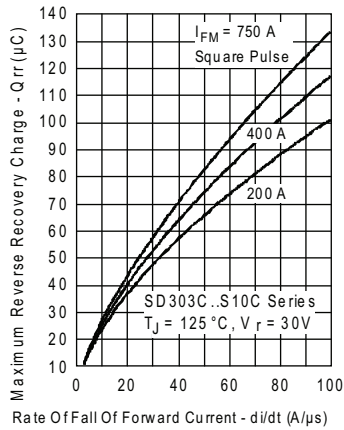

Fig. 13 - Recovery Charge Characteristics

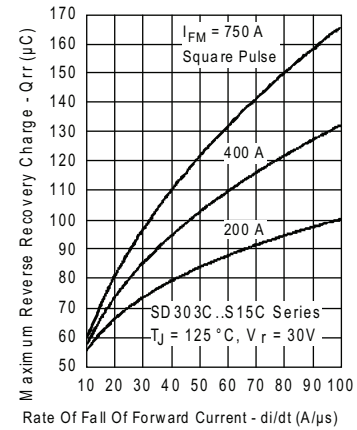

Fig. 16 - Recovery Charge Characteristics

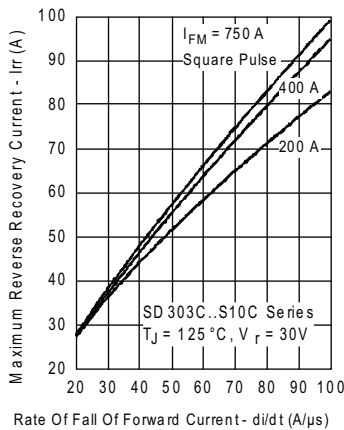

Fig. 14 - Recovery Current Characteristics

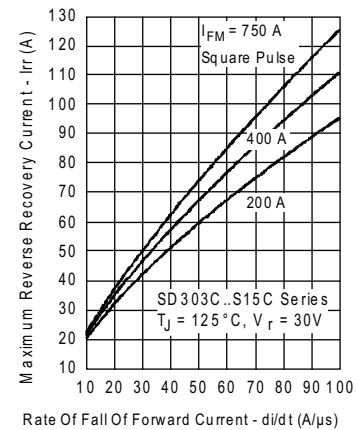

Fig. 17 - Recovery Current Characteristics

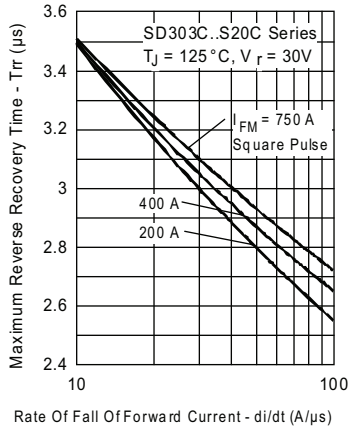

Fig. 18 - Recovery Time Characteristics

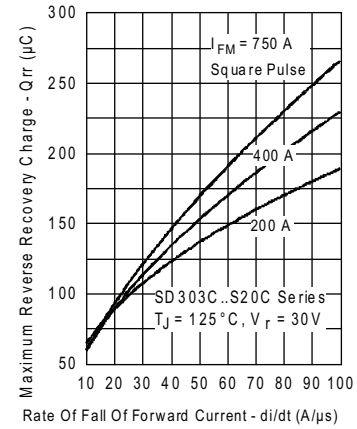

Fig. 19 - Recovery Charge Characteristics

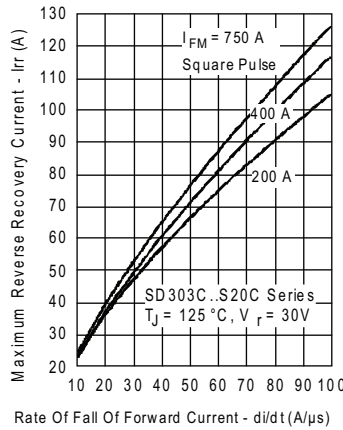

Fig. 20 - Recovery Current Characteristics

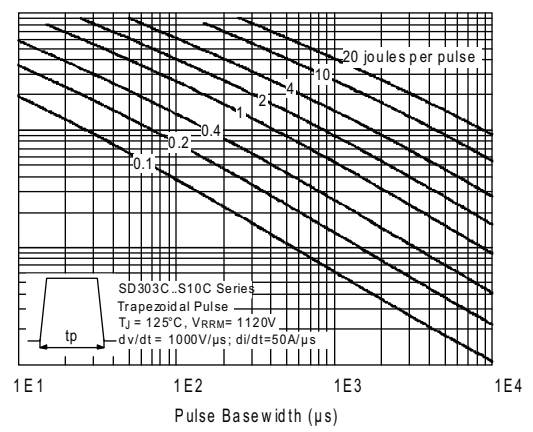
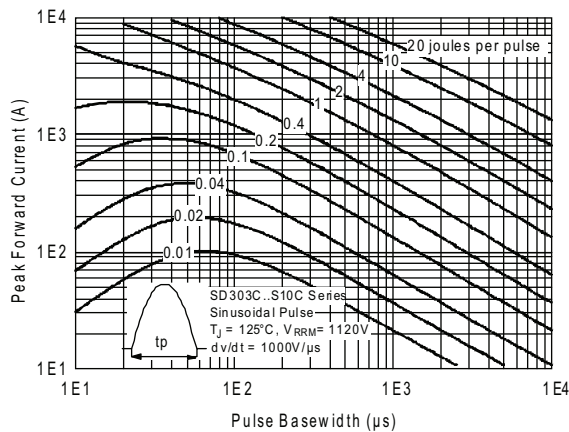

Fig. 21 - Maximum Total Energy Loss Per Pulse Characteristics

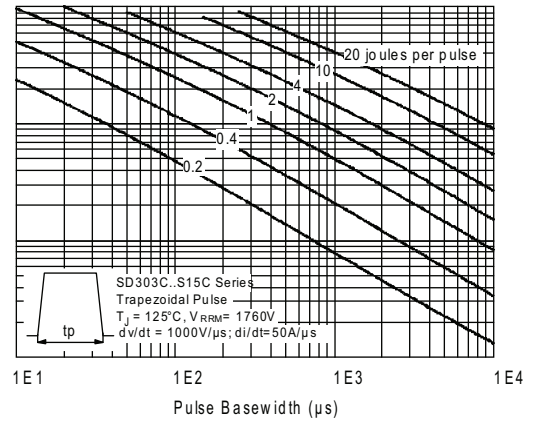
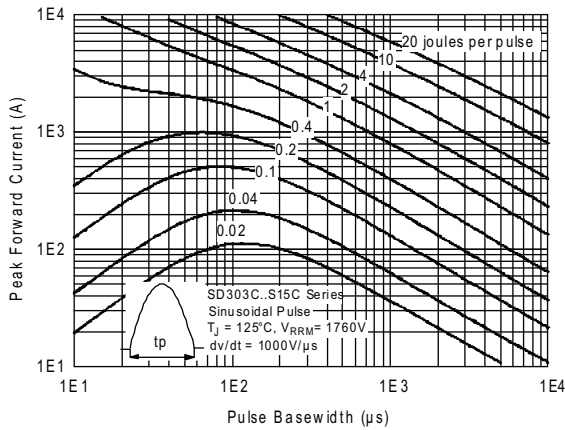

Fig. 22 - Maximum Total Energy Loss Per Pulse Characteristics

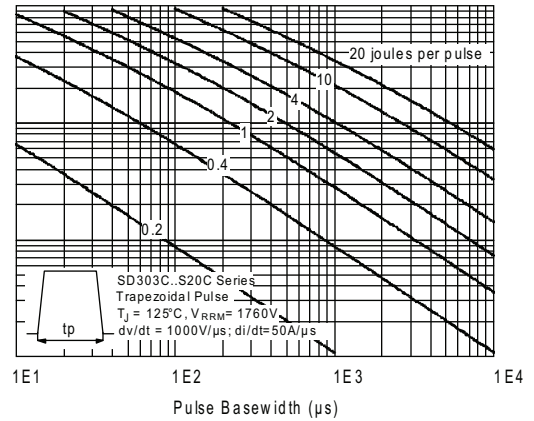
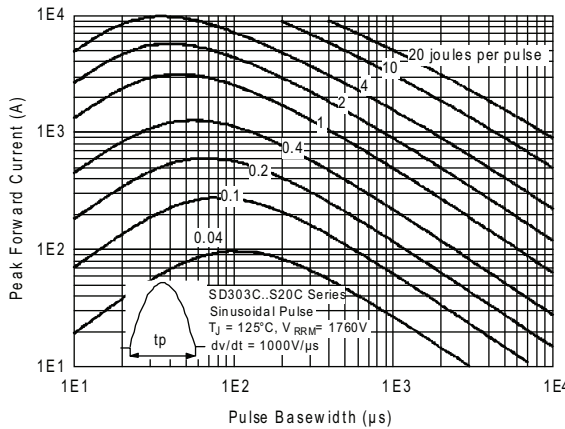

Fig. 23 - Maximum Total Energy Loss Per Pulse Characteristics

## ORDERING INFORMATION TABLE

|             |            |           |           |          |          |           |            |          |
|-------------|------------|-----------|-----------|----------|----------|-----------|------------|----------|
| Device code | <b>VS-</b> | <b>SD</b> | <b>30</b> | <b>3</b> | <b>C</b> | <b>25</b> | <b>S20</b> | <b>C</b> |
|-------------|------------|-----------|-----------|----------|----------|-----------|------------|----------|



- 1** - Vishay Semiconductors product
- 2** - Diode
- 3** - Essential part number
- 4** - 3 = fast recovery
- 5** - C = ceramic PUK
- 6** - Voltage code x 100 =  $V_{RRM}$  (see Voltage Ratings table)
- 7** -  $t_{rr}$  code (see Recovery Characteristics table)
- 8** - C = PUK case A-PUK (DO-200AA)

### LINKS TO RELATED DOCUMENTS

|            |  |
|------------|--|
| Dimensions | <a href="http://www.vishay.com/doc?95248">www.vishay.com/doc?95248</a> |
|------------|--|



## DO-200AA

**DIMENSIONS** in millimeters (inches)

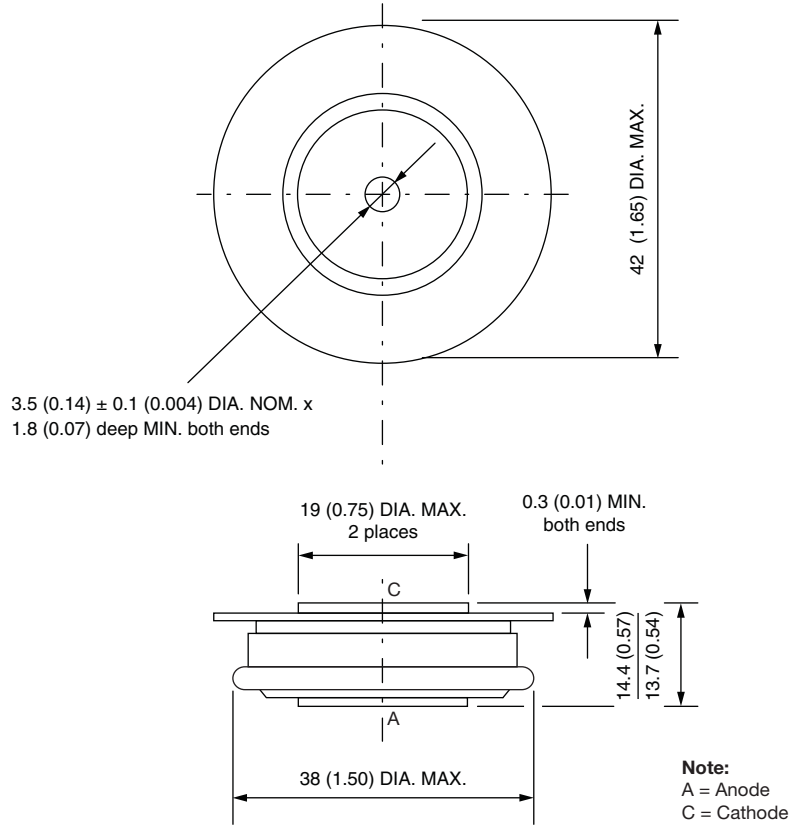

Quote between upper and lower pole pieces has to be considered after application of mounting force (see Thermal and Mechanical Specifications)





## Disclaimer

ALL PRODUCT, PRODUCT SPECIFICATIONS AND DATA ARE SUBJECT TO CHANGE WITHOUT NOTICE TO IMPROVE RELIABILITY, FUNCTION OR DESIGN OR OTHERWISE.

Vishay Intertechnology, Inc., its affiliates, agents, and employees, and all persons acting on its or their behalf (collectively, "Vishay"), disclaim any and all liability for any errors, inaccuracies or incompleteness contained in any datasheet or in any other disclosure relating to any product.

Vishay makes no warranty, representation or guarantee regarding the suitability of the products for any particular purpose or the continuing production of any product. To the maximum extent permitted by applicable law, Vishay disclaims (i) any and all liability arising out of the application or use of any product, (ii) any and all liability, including without limitation special, consequential or incidental damages, and (iii) any and all implied warranties, including warranties of fitness for particular purpose, non-infringement and merchantability.

Statements regarding the suitability of products for certain types of applications are based on Vishay's knowledge of typical requirements that are often placed on Vishay products in generic applications. Such statements are not binding statements about the suitability of products for a particular application. It is the customer's responsibility to validate that a particular product with the properties described in the product specification is suitable for use in a particular application. Parameters provided in datasheets and / or specifications may vary in different applications and performance may vary over time. All operating parameters, including typical parameters, must be validated for each customer application by the customer's technical experts. Product specifications do not expand or otherwise modify Vishay's terms and conditions of purchase, including but not limited to the warranty expressed therein.

Hyperlinks included in this datasheet may direct users to third-party websites. These links are provided as a convenience and for informational purposes only. Inclusion of these hyperlinks does not constitute an endorsement or an approval by Vishay of any of the products, services or opinions of the corporation, organization or individual associated with the third-party website. Vishay disclaims any and all liability and bears no responsibility for the accuracy, legality or content of the third-party website or for that of subsequent links.

Except as expressly indicated in writing, Vishay products are not designed for use in medical, life-saving, or life-sustaining applications or for any other application in which the failure of the Vishay product could result in personal injury or death. Customers using or selling Vishay products not expressly indicated for use in such applications do so at their own risk. Please contact authorized Vishay personnel to obtain written terms and conditions regarding products designed for such applications.

No license, express or implied, by estoppel or otherwise, to any intellectual property rights is granted by this document or by any conduct of Vishay. Product names and markings noted herein may be trademarks of their respective owners.

单击下面可查看定价，库存，交付和生命周期等信息

[>>Vishay\(威世\)](#)