

# International IOR Rectifier

## 161CMQ... SERIES

### SCHOTTKY RECTIFIER

160 Amp



#### Major Ratings and Characteristics

Characteristics	161CMQ...	Units
$I_{F(AV)}$ Rectangular waveform	160	A
$V_{RRM}$ range	30 to 50	V
$I_{FSM}$ @tp = 5 $\mu$ s sine	11,500	A
$V_F$ @80 Apk, $T_J = 125^\circ\text{C}$ (per leg)	0.63	V
$T_J$ range	-55 to 175	$^\circ\text{C}$

#### Description/ Features

The 161CMQ isolated center tap Schottky rectifier module series has been optimized for low reverse leakage at high temperature. The proprietary barrier technology allows for reliable operation up to 175 $^\circ\text{C}$  junction temperature. Typical applications are in switching power supplies, converters, free-wheeling diodes, and reverse battery protection.

- 175 $^\circ\text{C}$   $T_J$  operation
- Isolated heatsink
- Center tap module
- Multiple leads per terminal for high frequency, high current PC board mounting
- High purity, high temperature epoxy encapsulation for enhanced mechanical strength and moisture resistance
- Low forward voltage drop
- High frequency operation
- Guard ring for enhanced ruggedness and long term reliability
- Low profile, high current package

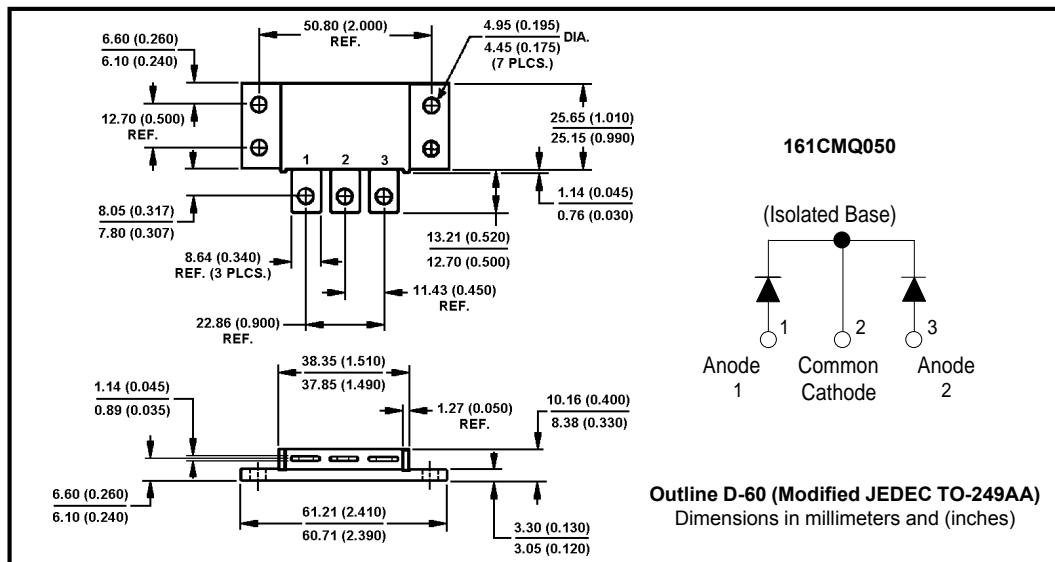

## 161CMQ... Series

Bulletin PD-2.174 rev. C 05/02

International  
IR Rectifier

### Voltage Ratings

Part number	161CMQ030	161CMQ035	161CMQ040	161CMQ045	161CMQ050
$V_R$ Max. DC Reverse Voltage (V)	30	35	40	45	50
$V_{RWM}$ Max. Working Peak Reverse Voltage (V)					

### Absolute Maximum Ratings

Parameters	161CMQ	Units	Conditions
$I_{F(AV)}$ Max. Average Forward Current * See Fig. 5	160	A	50% duty cycle @ $T_C = 101^\circ\text{C}$ , rectangular wave form
$I_{FSM}$ Max. Peak One Cycle Non-Repetitive Surge Current (Per Leg) * See Fig. 7	11,500	A	5 $\mu\text{s}$ Sine or 3 $\mu\text{s}$ Rect. pulse 10ms Sine or 6ms Rect. pulse
	900		
$E_{AS}$ Non-Repetitive Avalanche Energy (Per Leg)	108	mJ	$T_J = 25^\circ\text{C}$ , $I_{AS} = 16\text{Amps}$ , $L = 0.84\text{mH}$
$I_{AR}$ Repetitive Avalanche Current (Per Leg)	16	A	Current decaying linearly to zero in 1 $\mu\text{sec}$ Frequency limited by $T_J$ max. $V_A = 1.5 \times V_R$ typical

### Electrical Specifications

Parameters	161CMQ	Units	Conditions
$V_{FM}$ Max. Forward Voltage Drop (Per Leg) * See Fig. 1 (1)	0.71	V	@ 80A
	0.88	V	@ 160A
	0.63	V	@ 80A
	0.79	V	@ 160A
$I_{RM}$ Max. Reverse Leakage Current (Per Leg) * See Fig. 2 (1)	5	mA	$T_J = 25^\circ\text{C}$
	45	mA	$T_J = 125^\circ\text{C}$
$C_T$ Max. Junction Capacitance (Per Leg)	2600	pF	$V_R = 5V_{DC}$ , (test signal range 100Khz to 1Mhz) $25^\circ\text{C}$
$L_S$ Typical Series Inductance (Per Leg)	8.0	nH	Measured from terminal hole to terminal hole
$dv/dt$ Max. Voltage Rate of Change (Rated $V_R$ )	10000	V/ $\mu\text{s}$	

(1) Pulse Width < 300 $\mu\text{s}$ , Duty Cycle <2%

### Thermal-Mechanical Specifications

Parameters	161CMQ	Units	Conditions
$T_J$ Max. Junction Temperature Range	-55 to 175	$^\circ\text{C}$	
$T_{stg}$ Max. Storage Temperature Range	-55 to 175	$^\circ\text{C}$	
$R_{thJC}$ Max. Thermal Resistance Junction to Case (Per Leg)	1.0	$^\circ\text{C}/\text{W}$	DC operation * See Fig. 4
$R_{thJC}$ Max. Thermal Resistance Junction to Case (Per Package)	0.50	$^\circ\text{C}/\text{W}$	DC operation
$R_{thCS}$ Typical Thermal Resistance, Case to Heatsink	0.10	$^\circ\text{C}/\text{W}$	Mounting surface, smooth and greased
wt Approximate Weight	58 (2.0)	g (oz.)	
T Mounting Torque	Min. 40 (35)	Kg-cm (lbf-in)	
	Max. 58 (50)		
Case Style	TO-249AA	JEDEC	

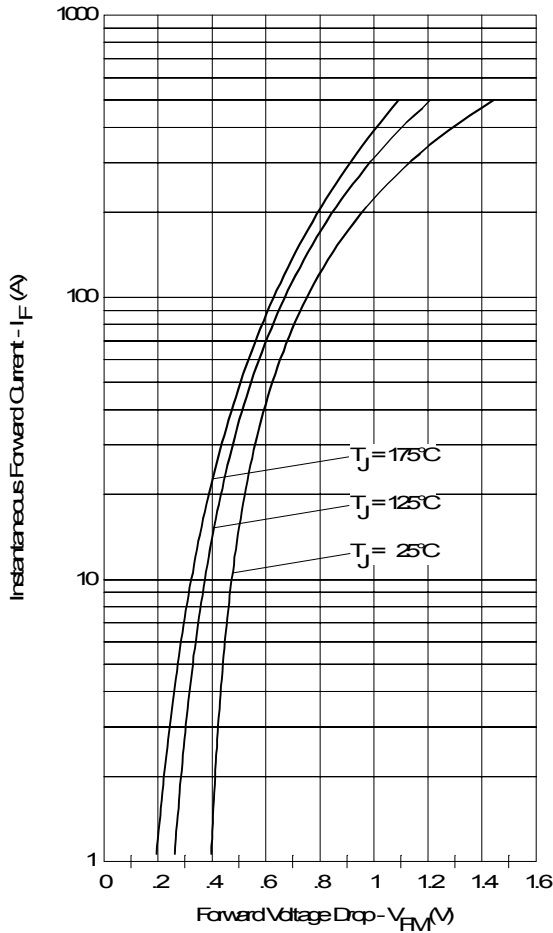

Fig. 1 - Max. Forward Voltage Drop Characteristics (Per Leg)

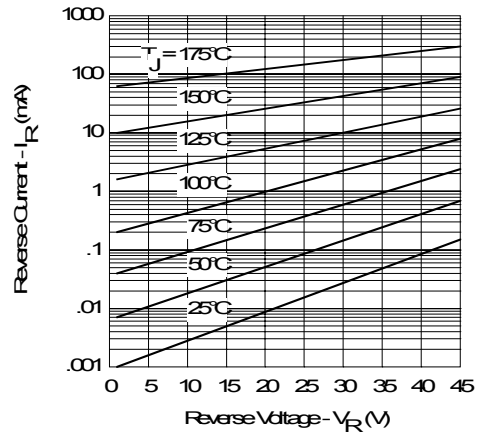

Fig. 2 - Typical Values Of Reverse Current Vs. Reverse Voltage (Per Leg)

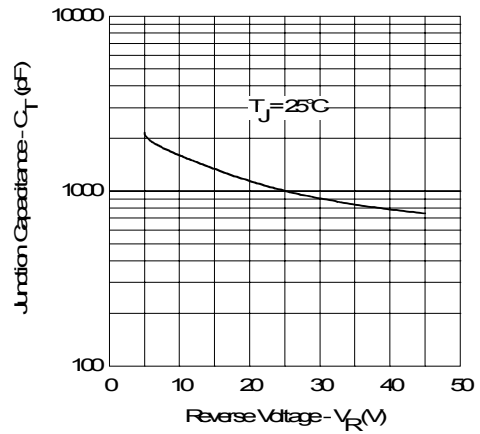

Fig. 3 - Typical Junction Capacitance Vs. Reverse Voltage (Per Leg)

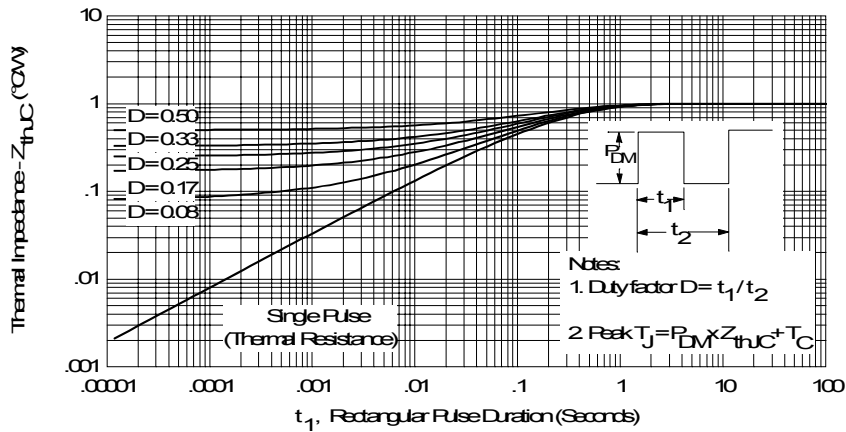

Fig. 4 - Max. Thermal Impedance  $Z_{thJC}$  Characteristics (Per Leg)

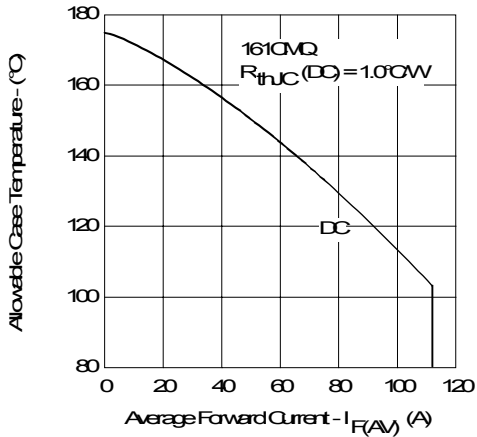

Fig. 5 - Max. Allowable Case Temperature Vs. Average Forward Current (Per Leg)

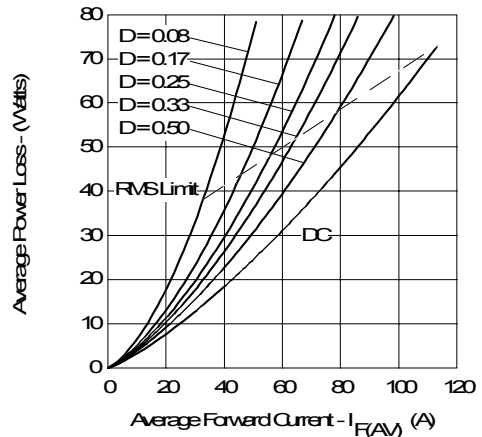

Fig. 6 - Forward Power Loss Characteristics (Per Leg)

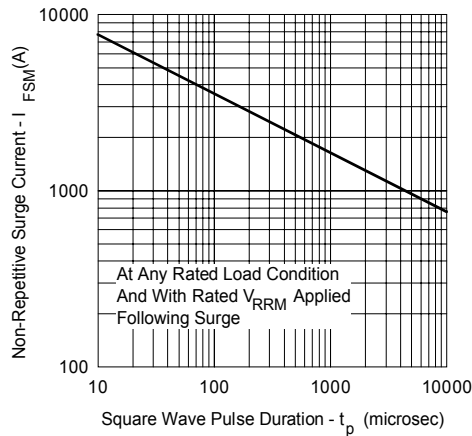

Fig. 7 - Max. Non-Repetitive Surge Current (Per Leg)

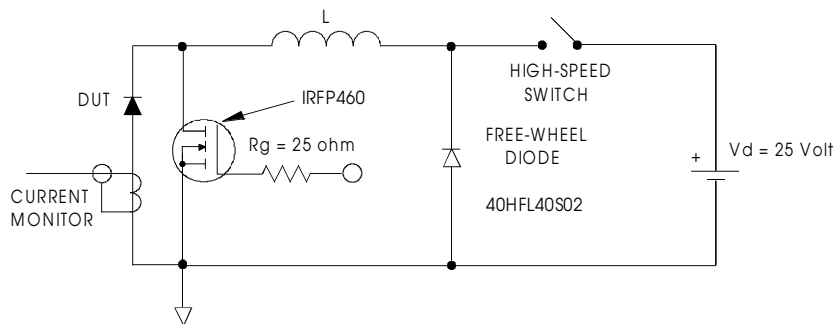

Fig. 8 - Unclamped Inductive Test Circuit

Data and specifications subject to change without notice.  
This product has been designed and qualified for Industrial Level.  
Qualification Standards can be found on IR's Web site.

International  
**IOR** Rectifier

**IR WORLD HEADQUARTERS:** 233 Kansas St., El Segundo, California 90245, USA Tel: (310) 252-7105  
TAC Fax: (310) 252-7309  
Visit us at [www.irf.com](http://www.irf.com) for sales contact information. 05/02

单击下面可查看定价，库存，交付和生命周期等信息

[>>Vishay\(威世\)](#)