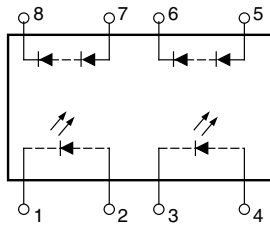
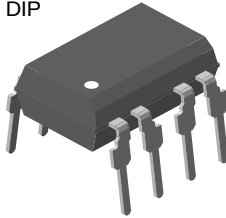
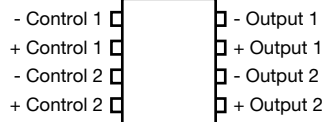
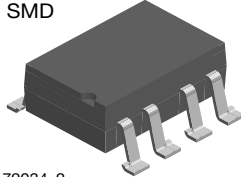


## Dual Photovoltaic MOSFET Driver Solid-State Relay

DIP



SMD



i179034\_2

### DESIGN SUPPORT TOOLS AVAILABLE



### DESCRIPTION

The VO1263AB and VO1263AAC photovoltaic MOSFET driver consists of two LEDs optically coupled to two photodiode arrays. The photodiode array provides a floating source with adequate voltage and current to drive high power MOSFET transistors. Optical coupling provides a high I/O isolation voltage. In order to turn the MOSFET off, an external resistance (gate-to-source) is required for gate discharge.

### FEATURES

- High open circuit voltage, up to 14.6 V typical
- High short circuit current, up to 42  $\mu$ A typical
- Isolation test voltage 5300 V<sub>RMS</sub>
- Logic compatible input
- High reliability
- Material categorization: for definitions of compliance please see [www.vishay.com/doc?99912](http://www.vishay.com/doc?99912)


**RoHS**  
COMPLIANT

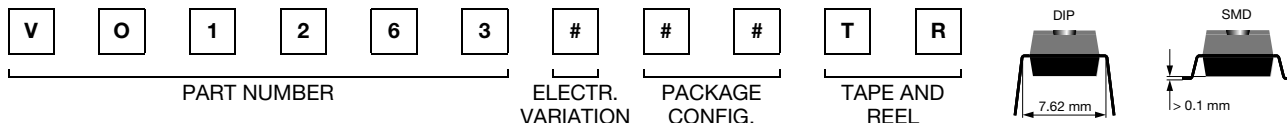
### APPLICATIONS

- High side driver
- Solid-state relays
- Floating power supply
- Power control
- Data acquisition
- ATE
- Isolated switching

### AGENCY APPROVALS

- [UL](#)
- [DIN EN 60747-5 \(VDE 0884-5\)](#)
- [BSI](#)
- [CQC](#)
- [FIMKO](#)

### ORDERING INFORMATION



PACKAGE	UL, VDE, BSI, CQC, FIMKO
SMD-8	VO1263AAC
SMD-8, tape and reel	VO1263AACTR
DIP-8	VO1263AB

### ABSOLUTE MAXIMUM RATINGS (T<sub>amb</sub> = 25 °C, unless otherwise specified)

PARAMETER	TEST CONDITION	SYMBOL	VALUE	UNIT
<b>SSR</b>				
LED input ratings continuous forward current		I <sub>F</sub>	50	mA
LED input ratings reverse voltage	I <sub>R</sub> ≤ 10 $\mu$ A	V <sub>R</sub>	5.0	V
Photodiode array reverse voltage	I <sub>R</sub> ≤ 2.0 $\mu$ A	V <sub>R</sub>	100	V
Ambient operating temperature range		T <sub>amb</sub>	-40 to +100	°C
Storage temperature range		T <sub>stg</sub>	-40 to +150	°C
Pin soldering temperature	t = 7.0 s max.	T <sub>slid</sub>	270	°C

### Note

- Stresses in excess of the absolute maximum ratings can cause permanent damage to the device. Functional operation of the device is not implied at these or any other conditions in excess of those given in the operational sections of this document. Exposure to absolute maximum ratings for extended periods of the time can adversely affect reliability



<b>ELECTRICAL CHARACTERISTICS</b> ( $T_{amb} = 25\text{ }^{\circ}\text{C}$ , unless otherwise specified)						
PARAMETER	TEST CONDITION	SYMBOL	MIN.	TYP.	MAX.	UNIT
LED forward voltage	$I_F = 10\text{ mA}$	$V_F$	1.2	1.3	1.6	V
Detector reverse voltage	$I_R = 2.0\text{ }\mu\text{A}$	$V_{R(PDA)}$	-	350	-	V
Open circuit voltage (pins 5, 6 or 7, 8)	$I_F = 5.0\text{ mA}$	$V_{OC}$	-	13.73	-	V
	$I_F = 10\text{ mA}$	$V_{OC}$	10.3	14.27	16.5	V
	$I_F = 15\text{ mA}$	$V_{OC}$	-	14.50	-	V
	$I_F = 20\text{ mA}$	$V_{OC}$	-	14.70	-	V
	$I_F = 30\text{ mA}$	$V_{OC}$	-	14.94	-	V
Short circuit current (pins 5, 6 or 7, 8)	$I_F = 5.0\text{ mA}$	$I_{SC}$	2.7	4.47	-	$\mu\text{A}$
	$I_F = 10\text{ mA}$	$I_{SC}$	7	9.8	-	$\mu\text{A}$
	$I_F = 15\text{ mA}$	$I_{SC}$	11	15.33	-	$\mu\text{A}$
	$I_F = 20\text{ mA}$	$I_{SC}$	15	20.97	-	$\mu\text{A}$
	$I_F = 30\text{ mA}$	$I_{SC}$	21	32.4	-	$\mu\text{A}$

**Note**

- Minimum and maximum values are testing requirements. Typical values are characteristics of the device and are the result of engineering evaluations. Typical values are for information only and are not part of the testing requirements

<b>SWITCHING CHARACTERISTICS</b> ( $T_{amb} = 25\text{ }^{\circ}\text{C}$ , unless otherwise specified)						
PARAMETER	TEST CONDITION	SYMBOL	MIN.	TYP.	MAX.	UNIT
Turn-on time	$I_F = 20\text{ mA}$ <sup>(1)</sup>	$t_{on}$	-	16	-	$\mu\text{s}$
Turn-off time	$I_F = 20\text{ mA}$ <sup>(1)</sup>	$t_{off}$	-	472	-	$\mu\text{s}$

**Note**

- <sup>(1)</sup>  $f = 1.0\text{ kHz}$ , pulse width =  $100\text{ }\mu\text{s}$ , load ( $R_L$ ) =  $1.0\text{ M}\Omega$ ,  $15\text{ pF}$ ; measured at 90 % rated voltage ( $t_{on}$ ), 10 % rated voltage ( $t_{off}$ ). Actuation speed depends upon the external  $t_{on}$  and  $t_{off}$  circuitry and the capacitance of the MOSFET

<b>SAFETY AND INSULATION RATINGS</b>				
PARAMETER	TEST CONDITION	SYMBOL	VALUE	UNIT
Climatic classification	According to IEC 68 part 1		40 / 100 / 21	
Pollution degree	According to DIN VDE 0109		2	
Comparative tracking index	Insulation group IIIa	CTI	175	
Maximum rated withstanding isolation voltage	According to UL1577, $t = 1\text{ min}$	$V_{ISO}$	5300	$V_{RMS}$
Maximum transient isolation voltage	According to DIN EN 60747-5-5	$V_{IOTM}$	8000	$V_{peak}$
Maximum repetitive peak isolation voltage	According to DIN EN 60747-5-5	$V_{IORM}$	890	$V_{peak}$
Output safety power		$P_{SO}$	700	mW
Input safety current		$I_{SI}$	300	mA
Input safety temperature		$T_S$	175	$^{\circ}\text{C}$
Creepage distance	DIP-8, SMD-8		$\geq 7$	mm
Clearance distance			$\geq 7$	mm

**Note**

- This optocoupler is suitable for "safe electrical insulation" only within the safety ratings. Compliance with the safety ratings shall be ensured by means of suitable protective circuits

**FUNCTIONAL DESCRIPTION**

Fig. 1 outlines the IV characteristics of the illuminated photodiode array (PDA). For operation at voltages below  $V_{OC}$ , the PDA acts as a nearly constant current source. The actual region of operation depends upon the load.

The amount of current applied to the LED (pins 1 and 2 or 3 and 4) determines the amount of light produced for the PDA. For high temperature operation, more LED current may be required.

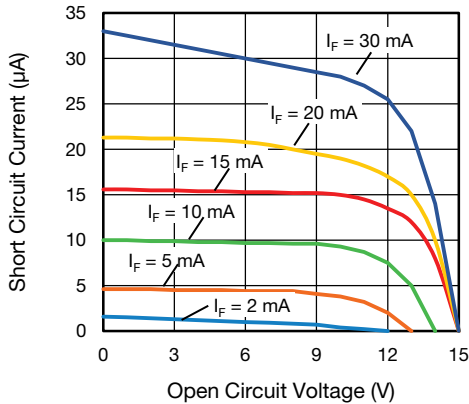
**TYPICAL CHARACTERISTICS** ( $T_{amb} = 25\text{ }^{\circ}\text{C}$ , unless otherwise specified)


Fig. 1 - Short Circuit Current vs. Open Circuit Voltage

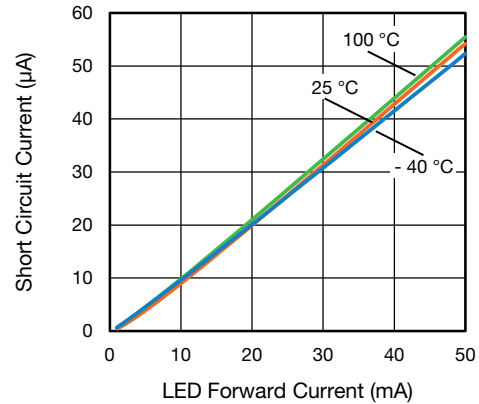


Fig. 3 - Short Circuit Current vs. LED Forward Current

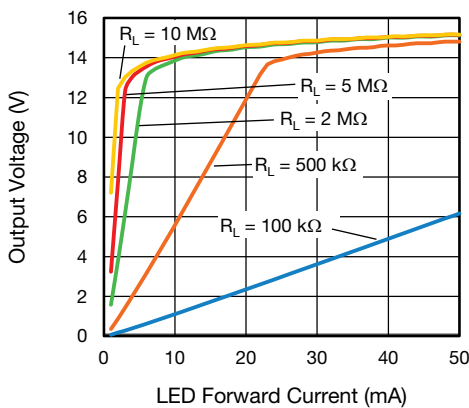


Fig. 2 - Output Voltage vs. LED Current

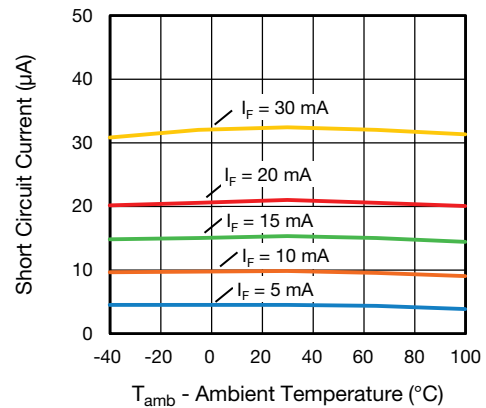


Fig. 4 - Short Circuit Current vs. Ambient Temperature

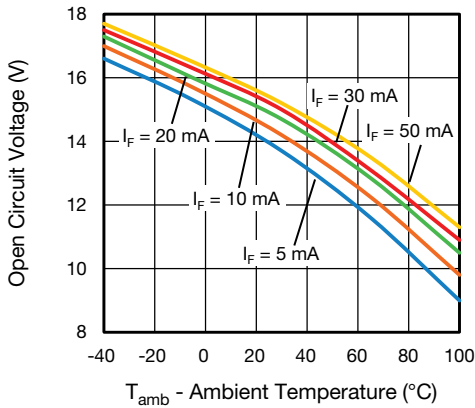


Fig. 5 - Open Circuit Voltage vs. Ambient Temperature

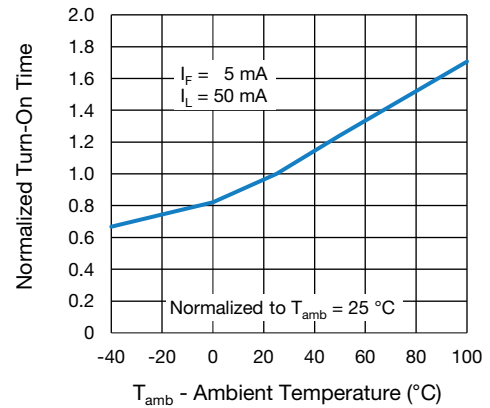


Fig. 8 - Normalized Turn-On Time vs. Ambient Temperature

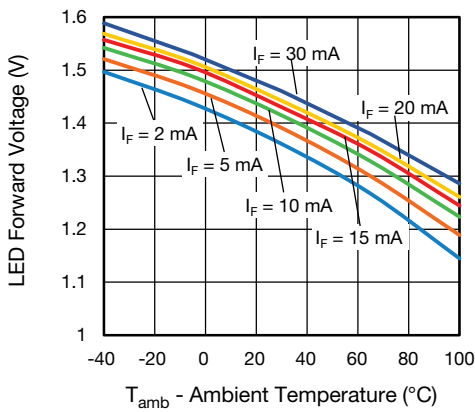


Fig. 6 - LED Forward Voltage vs. Ambient Temperature

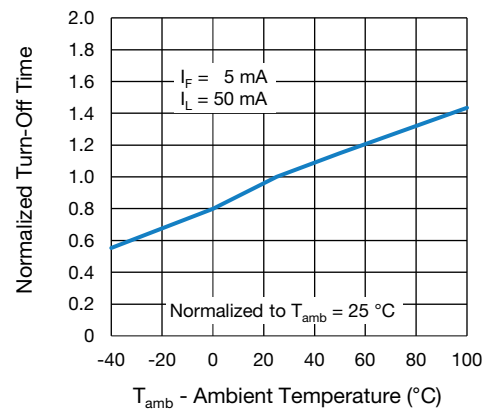


Fig. 9 - Normalized Turn-Off Time vs. Ambient Temperature

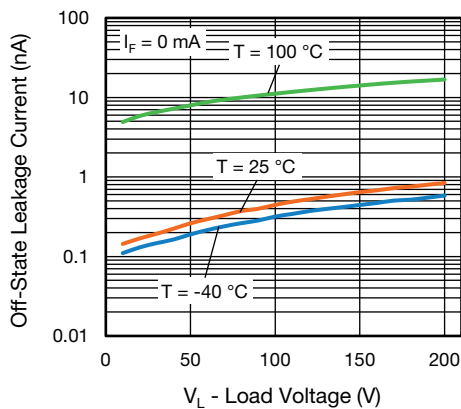


Fig. 7 - Leakage Current vs. Load Voltage

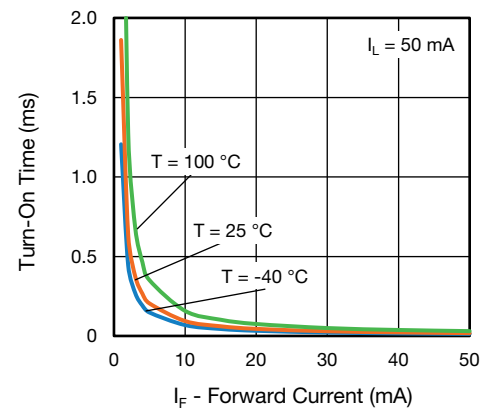


Fig. 10 - Turn-On Time vs. Forward Current

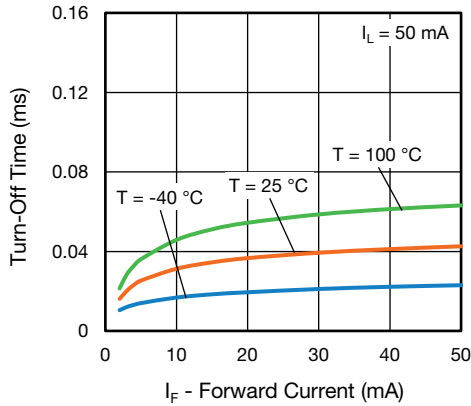
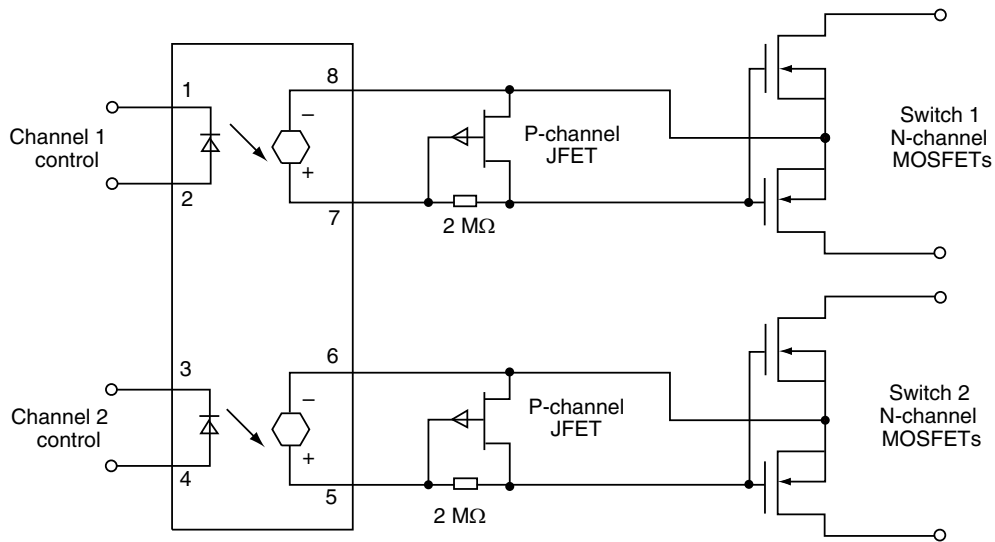


Fig. 11 - Turn-Off Time vs. Forward Current



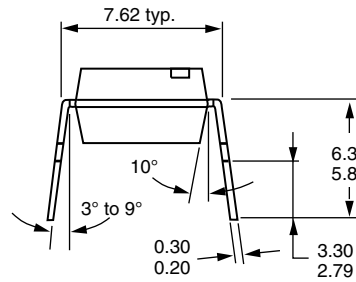
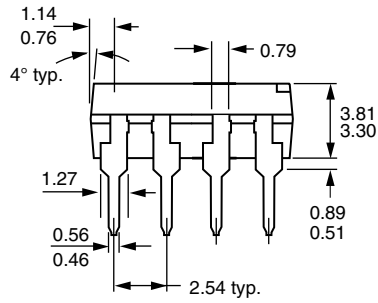
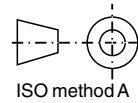
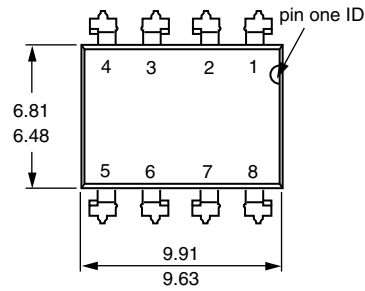
ih1262cb\_09

Fig. 12 - Typical Dual Form A Solid-State Relay Application



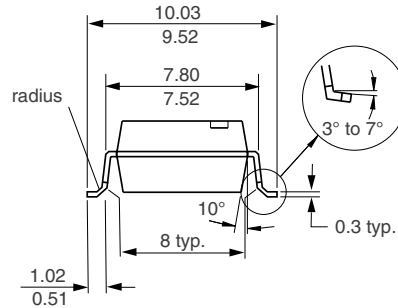
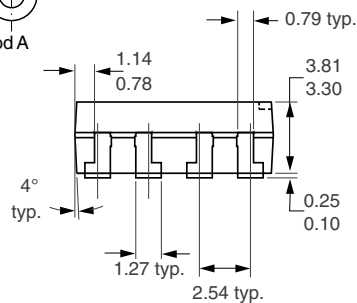
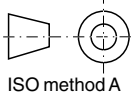
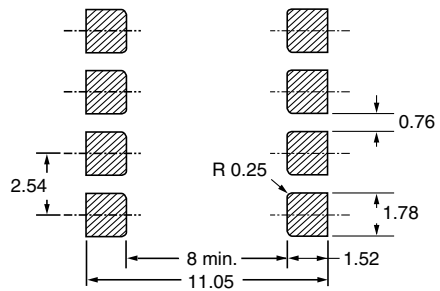
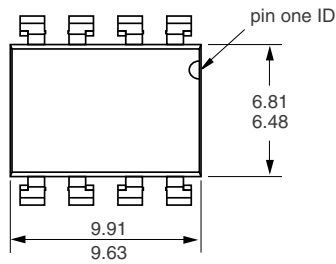
PACKAGE DIMENSIONS in millimeters

DIP



i178008

SMD



i178009

PACKAGE MARKING (example)

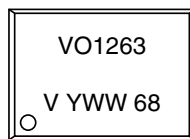
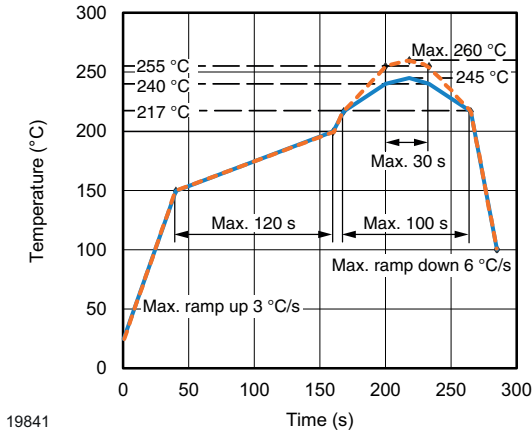


Fig. 13 - Example of VO1263AAC

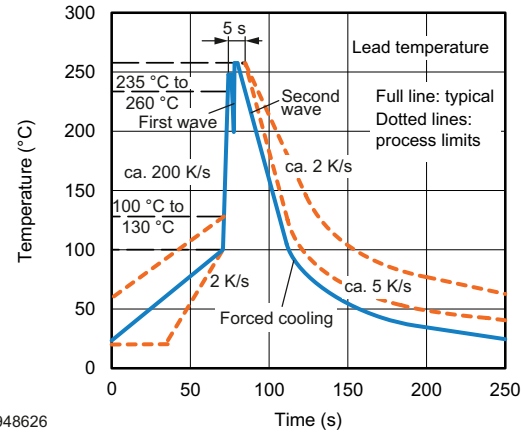


SOLDER PROFILES



19841

Fig. 14 - Lead (Pb)-free Reflow Solder Profile According to J-STD-020 for SMD Devices



948626

Fig. 15 - Wave Soldering Double Wave Profile According to J-STD-020 for DIP Devices



## **Disclaimer**

ALL PRODUCT, PRODUCT SPECIFICATIONS AND DATA ARE SUBJECT TO CHANGE WITHOUT NOTICE TO IMPROVE RELIABILITY, FUNCTION OR DESIGN OR OTHERWISE.

Vishay Intertechnology, Inc., its affiliates, agents, and employees, and all persons acting on its or their behalf (collectively, "Vishay"), disclaim any and all liability for any errors, inaccuracies or incompleteness contained in any datasheet or in any other disclosure relating to any product.

Vishay makes no warranty, representation or guarantee regarding the suitability of the products for any particular purpose or the continuing production of any product. To the maximum extent permitted by applicable law, Vishay disclaims (i) any and all liability arising out of the application or use of any product, (ii) any and all liability, including without limitation special, consequential or incidental damages, and (iii) any and all implied warranties, including warranties of fitness for particular purpose, non-infringement and merchantability.

Statements regarding the suitability of products for certain types of applications are based on Vishay's knowledge of typical requirements that are often placed on Vishay products in generic applications. Such statements are not binding statements about the suitability of products for a particular application. It is the customer's responsibility to validate that a particular product with the properties described in the product specification is suitable for use in a particular application. Parameters provided in datasheets and / or specifications may vary in different applications and performance may vary over time. All operating parameters, including typical parameters, must be validated for each customer application by the customer's technical experts. Product specifications do not expand or otherwise modify Vishay's terms and conditions of purchase, including but not limited to the warranty expressed therein.

Except as expressly indicated in writing, Vishay products are not designed for use in medical, life-saving, or life-sustaining applications or for any other application in which the failure of the Vishay product could result in personal injury or death. Customers using or selling Vishay products not expressly indicated for use in such applications do so at their own risk. Please contact authorized Vishay personnel to obtain written terms and conditions regarding products designed for such applications.

No license, express or implied, by estoppel or otherwise, to any intellectual property rights is granted by this document or by any conduct of Vishay. Product names and markings noted herein may be trademarks of their respective owners.



单击下面可查看定价，库存，交付和生命周期等信息

[>>Vishay\(威世\)](#)