

## 4-Line BUS-Port ESD-Protection

### Features

- Ultra compact LLP75-6A package
- 4-line USB ESD-protection
- Low leakage current
- Low load capacitance  $C_D = 1.2$  pF
- ESD-protection acc. IEC 61000-4-2  
 $\pm 30$  kV contact discharge  
 $\pm 30$  kV air discharge
- High surge current acc. IEC61000-4-5  $I_{PP} > 11$  A
- Lead (Pb)-free component
- Component in accordance to RoHS 2002/95/EC and WEEE 2002/96/EC



**RoHS**  
COMPLIANT  
**GREEN**  
[5-2008]\*

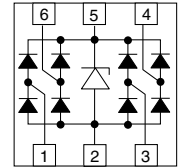
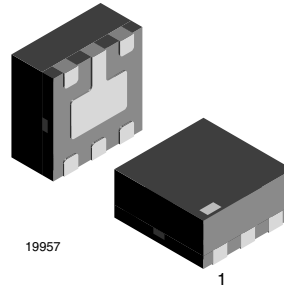

19957

20397

### Marking (example only)

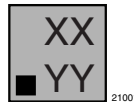

Dot = Pin 1 marking  
 XX = Date code  
 YY = Type code (see table below)

### Ordering Information

Device name	Ordering code	Taped units per reel (8 mm tape on 7" reel)	Minimum order quantity
VBUS054CV-HS3	VBUS054CV-HS3-GS08	3000	15000

### Package Data

Device name	Package name	Marking code	Weight	Molding compound flammability rating	Moisture sensitivity level	Soldering conditions
VBUS054CV-HS3	LLP75-6A	U8	5.1 mg	UL 94 V-0	MSL level 1 (according J-STD-020)	260 °C/10 s at terminals

### Absolute Maximum Ratings

Parameter	Test conditions	Symbol	Value	Unit
Peak pulse current	Pin 1, 3, 4 or 6 to pin 2 acc. IEC 61000-4-5; $t_p = 8/20$ $\mu$ s; single shot	$I_{PPM}$	11	A
	Pin 5 to pin 2 acc. IEC 61000-4-5; $t_p = 8/20$ $\mu$ s; single shot	$I_{PPM}$	13	A
Peak pulse power	Pin 1, 3, 4 or 6 to pin 2 acc. IEC 61000-4-5; $t_p = 8/20$ $\mu$ s; single shot	$P_{PP}$	242	W
	Pin 5 to pin 2 acc. IEC 61000-4-5; $t_p = 8/20$ $\mu$ s; single shot	$P_{PP}$	246	W
ESD immunity	Contact discharge acc. IEC 61000-4-2; 10 pulses	$V_{ESD}$	$\pm 30$	kV
	Air discharge acc. IEC 61000-4-2; 10 pulses	$V_{ESD}$	$\pm 30$	kV
Operating temperature	Junction temperature	$T_J$	- 40 to + 125	°C
Storage temperature		$T_{STG}$	- 40 to + 150	°C

\* Please see document "Vishay Green and Halogen-Free Definitions (5-2008)" <http://www.vishay.com/doc?99902>

## Electrical Characteristics

Ratings at 25 °C, ambient temperature unless otherwise specified

### VBUS054CV-HS3

Date line: pin 1 , 3, 4 or 6 to pin 2

Parameter	Test conditions/remarks	Symbol	Min.	Typ.	Max.	Unit
Protection paths	Number of line which can be protected	$N_{lines}$			4	lines
Reverse working voltage	at $I_R = 0.1 \mu A$	$V_{RWM}$	5			V
Reverse current	at $V_{IN} = V_{RWM} = 5 V$	$I_R$		< 0.01	0.1	$\mu A$
Reverse breakdown voltage	at $I_R = 1 mA$	$V_{BR}$	7	7.9	8.6	V
Reverse clamping voltage	at $I_{PP} = 11 A$ ; acc. IEC 61000-4-5	$V_C$		18	22	V
Forward clamping voltage	at $I_F = 11 A$ ; acc. IEC 61000-4-5	$V_F$		6.5	8	V
Data line capacitance	$V_R$ (at I/O pin) = 0 V; $V_R$ (at pin 5) = 5 V; f = 1 MHz	$C_D$		1.2	2.5	pF
Line Symmetry	Difference of the line capacitances	$dC_D$			0.2	pF

### VBUS054CV-HS3

$V_{BUS}$ -line: pin 5 to pin 2

Parameter	Test conditions/remarks	Symbol	Min.	Typ.	Max.	Unit
Reverse working voltage	at $I_R = 0.1 \mu A$	$V_{RWM}$	5	6.6		V
Reverse current	at $V_{IN} = V_{RWM} = 5 V$	$I_R$		< 0.01	0.1	$\mu A$
Reverse breakdown voltage	at $I_R = 1 mA$	$V_{BR}$	7	7.9	8.6	V
Reverse clamping voltage	at $I_{PP} = 13 A$ ; acc. IEC 61000-4-5	$V_C$		18	22	V
Forward clamping voltage	at $I_F = 13 A$ ; acc. IEC 61000-4-5	$V_F$			7	V
Line capacitance	$V_R$ (at pin 5) = 0 V; f = 1 MHz	$C_D$		190		pF

## Application Note

With the VBUS054CV-HS3 a double, high speed USB-port can be protected against transient voltage signals. Negative transients will be clamped close below the ground level while positive transients will be clamped close above the 5 V working range. An avalanche diode clamps the supply line ( $V_{BUS}$  at pin 5) to ground (pin 2). The high speed data lines, D1+, D2+, D1- and D2-, are connected to pin 1, 3, 4 and 6. As long as the signal voltage on the data lines is between the ground- and the  $V_{BUS}$ -level, the low capacitance PN-diodes offer a very high isolation to  $V_{BUS}$ , ground and to the other data lines. But as soon as any transient signal exceeds this working range, one of the PN-diodes gets in the forward mode and clamps the transient to ground or the avalanche break through voltage level.

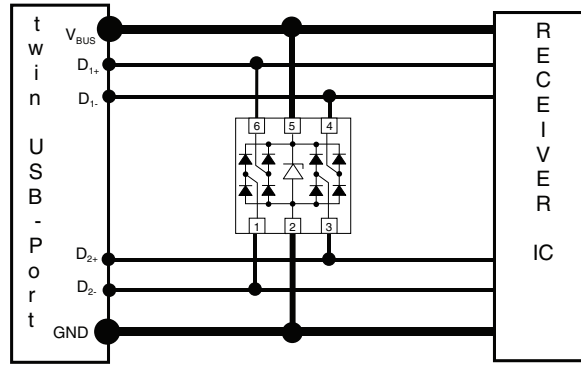

## Typical Characteristics

$T_{amb} = 25\text{ }^{\circ}\text{C}$ , unless otherwise specified

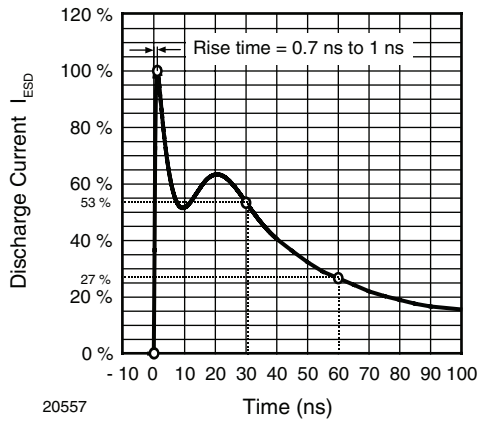

Figure 1. ESD Discharge Current Wave Form acc. IEC 61000-4-2 (330  $\Omega$ /150 pF)

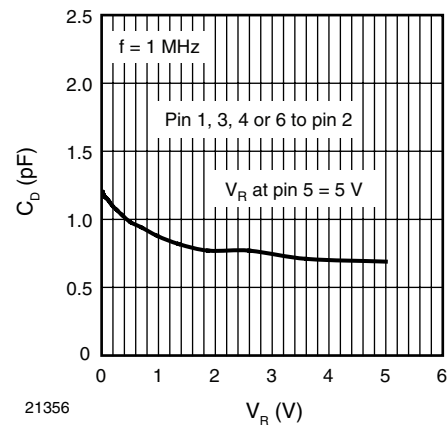

Figure 3. Typical Capacitance  $C_D$  vs. Reverse Voltage  $V_R$

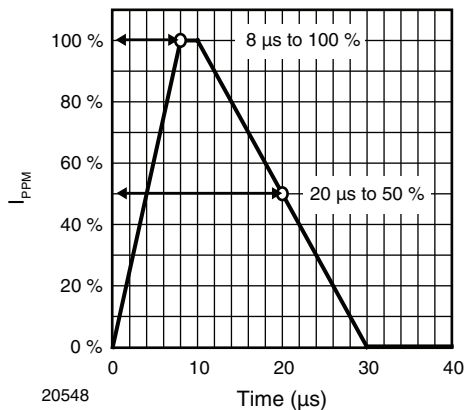

Figure 2. 8/20  $\mu\text{s}$  Peak Pulse Current Wave Form acc. IEC 61000-4-5

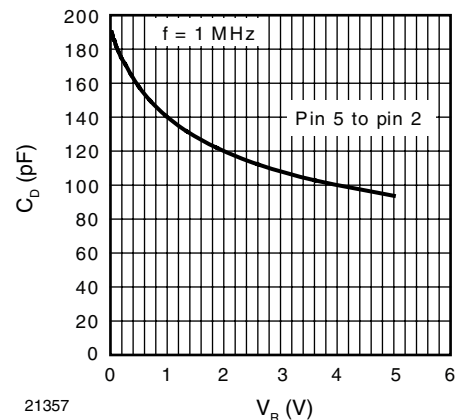

Figure 4. Typical Capacitance  $C_D$  vs. Reverse Voltage  $V_R$

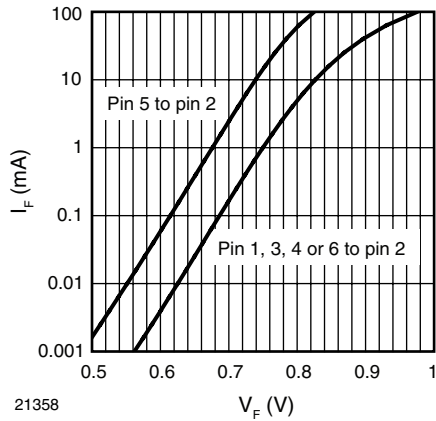

Figure 5. Typical Forward Current  $I_F$  vs. Forward Voltage  $V_F$

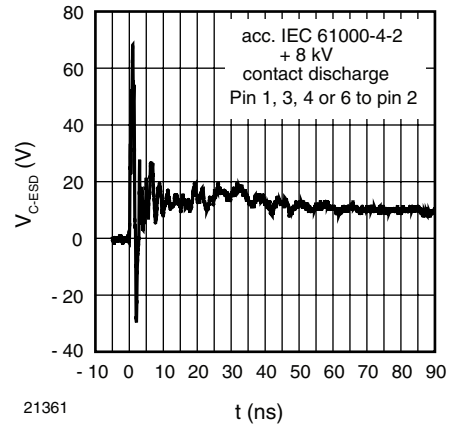

Figure 8. Typical Clamping Performance at + 8 kV Contact Discharge (acc. IEC 61000-4-2)

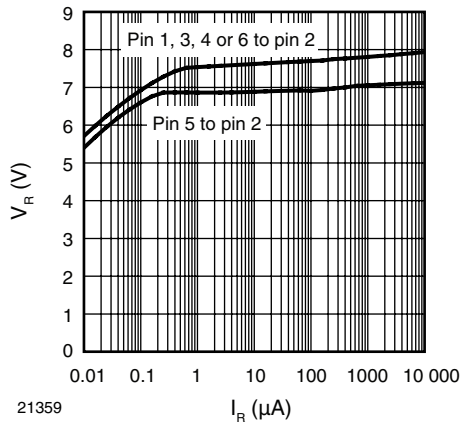

Figure 6. Typical Reverse Voltage  $V_R$  vs. Reverse Current  $I_R$

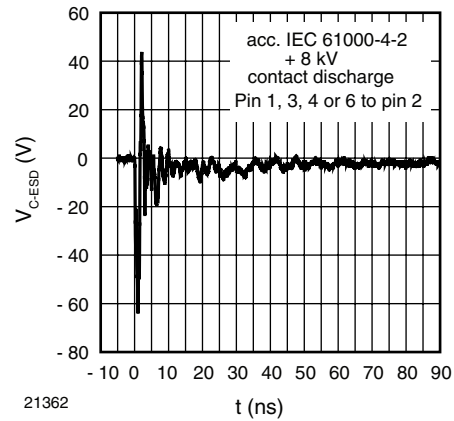

Figure 9. Typical Clamping performance at - 8 kV Contact Discharge (acc. IEC 61000-4-2)

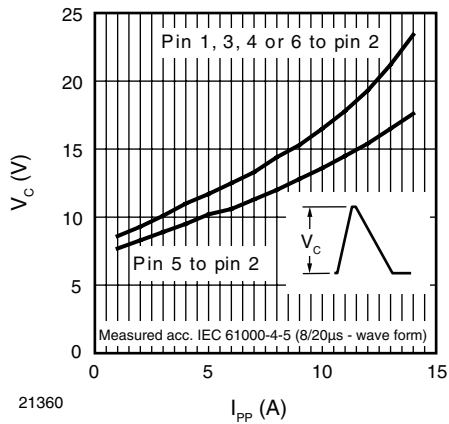

Figure 7. Typical Peak Clamping Voltage  $V_C$  vs. Peak Pulse Current  $I_{PP}$

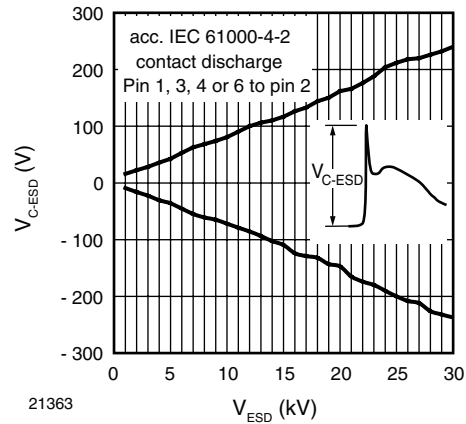
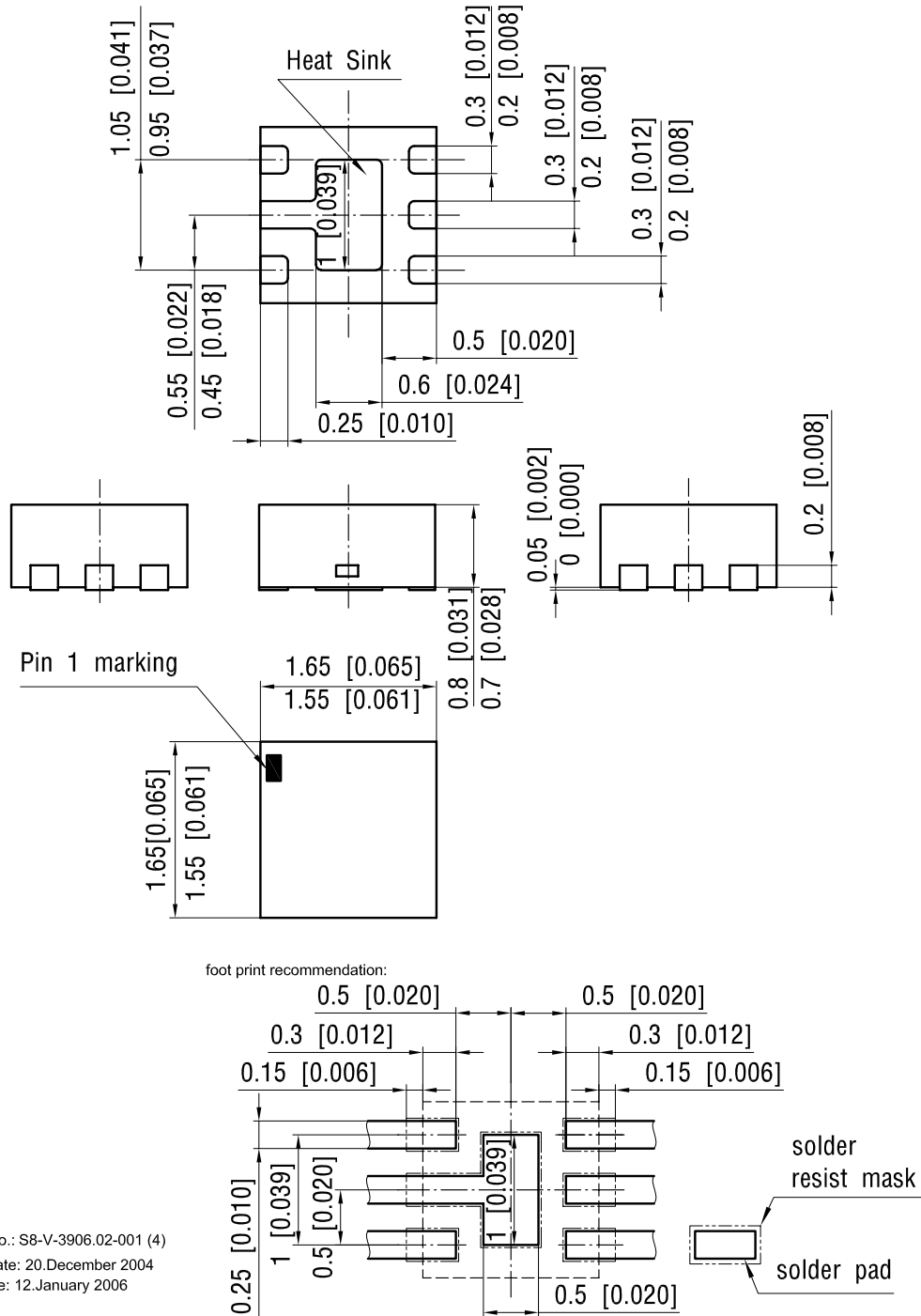

Figure 10. Typical Peak Clamping Voltage at ESD Contact Discharge (acc. IEC 61000-4-2)

**Package Dimensions** in millimeters (inches): **LLP75-6A**



Document no.: S8-V-3906.02-001 (4)  
 Created - Date: 20.December 2004  
 Rev. b - Date: 12.January 2006  
 18058

### Ozone Depleting Substances Policy Statement

It is the policy of Vishay Semiconductor GmbH to

1. Meet all present and future national and international statutory requirements.
2. Regularly and continuously improve the performance of our products, processes, distribution and operating systems with respect to their impact on the health and safety of our employees and the public, as well as their impact on the environment.

It is particular concern to control or eliminate releases of those substances into the atmosphere which are known as ozone depleting substances (ODSs).

The Montreal Protocol (1987) and its London Amendments (1990) intend to severely restrict the use of ODSs and forbid their use within the next ten years. Various national and international initiatives are pressing for an earlier ban on these substances.

Vishay Semiconductor GmbH has been able to use its policy of continuous improvements to eliminate the use of ODSs listed in the following documents.

1. Annex A, B and list of transitional substances of the Montreal Protocol and the London Amendments respectively.
2. Class I and II ozone depleting substances in the Clean Air Act Amendments of 1990 by the Environmental Protection Agency (EPA) in the USA.
3. Council Decision 88/540/EEC and 91/690/EEC Annex A, B and C (transitional substances) respectively.

Vishay Semiconductor GmbH can certify that our semiconductors are not manufactured with ozone depleting substances and do not contain such substances.

We reserve the right to make changes to improve technical design  
and may do so without further notice.

Parameters can vary in different applications. All operating parameters must be validated for each customer application by the customer. Should the buyer use Vishay Semiconductors products for any unintended or unauthorized application, the buyer shall indemnify Vishay Semiconductors against all claims, costs, damages, and expenses, arising out of, directly or indirectly, any claim of personal damage, injury or death associated with such unintended or unauthorized use.

Vishay Semiconductor GmbH, P.O.B. 3535, D-74025 Heilbronn, Germany



## Disclaimer

ALL PRODUCT, PRODUCT SPECIFICATIONS AND DATA ARE SUBJECT TO CHANGE WITHOUT NOTICE TO IMPROVE RELIABILITY, FUNCTION OR DESIGN OR OTHERWISE.

Vishay Intertechnology, Inc., its affiliates, agents, and employees, and all persons acting on its or their behalf (collectively, "Vishay"), disclaim any and all liability for any errors, inaccuracies or incompleteness contained in any datasheet or in any other disclosure relating to any product.

Vishay makes no warranty, representation or guarantee regarding the suitability of the products for any particular purpose or the continuing production of any product. To the maximum extent permitted by applicable law, Vishay disclaims (i) any and all liability arising out of the application or use of any product, (ii) any and all liability, including without limitation special, consequential or incidental damages, and (iii) any and all implied warranties, including warranties of fitness for particular purpose, non-infringement and merchantability.

Statements regarding the suitability of products for certain types of applications are based on Vishay's knowledge of typical requirements that are often placed on Vishay products in generic applications. Such statements are not binding statements about the suitability of products for a particular application. It is the customer's responsibility to validate that a particular product with the properties described in the product specification is suitable for use in a particular application. Parameters provided in datasheets and/or specifications may vary in different applications and performance may vary over time. All operating parameters, including typical parameters, must be validated for each customer application by the customer's technical experts. Product specifications do not expand or otherwise modify Vishay's terms and conditions of purchase, including but not limited to the warranty expressed therein.

Except as expressly indicated in writing, Vishay products are not designed for use in medical, life-saving, or life-sustaining applications or for any other application in which the failure of the Vishay product could result in personal injury or death. Customers using or selling Vishay products not expressly indicated for use in such applications do so at their own risk and agree to fully indemnify and hold Vishay and its distributors harmless from and against any and all claims, liabilities, expenses and damages arising or resulting in connection with such use or sale, including attorneys fees, even if such claim alleges that Vishay or its distributor was negligent regarding the design or manufacture of the part. Please contact authorized Vishay personnel to obtain written terms and conditions regarding products designed for such applications.

No license, express or implied, by estoppel or otherwise, to any intellectual property rights is granted by this document or by any conduct of Vishay. Product names and markings noted herein may be trademarks of their respective owners.

单击下面可查看定价，库存，交付和生命周期等信息

[>>Vishay\(威世\)](#)