

Optocoupler, Photodarlington Output, Low Input Current, High Gain, with Base Connection

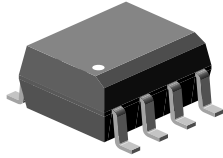

I179022

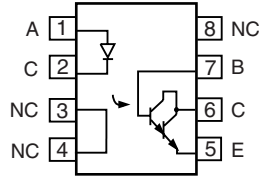

DESCRIPTION

The IL221AT/IL222AT/IL223AT is a high current transfer ratio (CTR) optocoupler with a gallium arsenide infrared LED emitter and a silicon NPN photodarlington transistor detector.

The device has a CTR tested at 1.0 mA LED current. This low drive current permits easy interfacing from CMOS to LSTTL or TTL.

This optocoupler is constructed in a standard SOIC-8 foot print which makes it ideally suited for high density applications. In addition to eliminating through-hole requirements, this package conforms to standards for surface mount devices.

FEATURES

- Isolation test voltage, 4000 V_{RMS}
- Industry standard SOIC-8 surface mountable package
- Standard lead spacing, 0.05"
- Available only on tape and reel (conforms to EIA standard RS481A)
- Compatible with dual wave, vapor phase and IR reflow soldering
- Lead (Pb)-free component
- Component in accordance to RoHS 2002/95/EC and WEEE 2002/96/EC



RoHS
COMPLIANT

AGENCY APPROVALS

- UL1577, file no. E52744 system code Y
- CUL - file no. E52744, equivalent to CSA bulletin 5A
- DIN EN 60747-5-5 available with option 1

ORDER INFORMATION	
PART	REMARKS
IL221AT	CTR > 100 %, SOIC-8
IL222AT	CTR > 200 %, SOIC-8
IL223AT	CTR > 500 %, SOIC-8

ABSOLUTE MAXIMUM RATINGS				
PARAMETER	TEST CONDITION	SYMBOL	VALUE	UNIT
INPUT				
Peak reverse voltage		V _R	6.0	V
Forward continuous current		I _F	60	mA
Power dissipation		P _{diss}	90	mW
Derate linearly from 25 °C			1.2	mW/°C
OUTPUT				
Collector emitter breakdown voltage		BV _{CEO}	30	V
Emitter collector breakdown voltage		BV _{ECO}	5.0	V
Collector base breakdown voltage		BV _{CBO}	70	V
I _C MAX DC		I _C MAX DC	50	mA
I _C MAX	t < 1.0 ms	I _C MAX	100	mW
Power dissipation		P _{diss}	150	mW
Derate linearly from 25 °C			2.0	mW/°C



Optocoupler, Photodarlington Output, Vishay Semiconductors
Low Input Current, High Gain, with Base
Connection

ABSOLUTE MAXIMUM RATINGS				
PARAMETER	TEST CONDITION	SYMBOL	VALUE	UNIT
COUPLER				
Isolation test voltage	t = 1.0 s	V _{ISO}	4000	V _{RMS}
Total package dissipation (at 25 °C ambient)(LED and detector)		P _{tot}	240	mW
Derate linearly from 25 °C			3.2	mW/°C
Storage temperature		T _{stg}	- 55 to + 150	°C
Operating temperature		T _{amb}	- 55 to + 100	°C
Soldering time at 260 °C			10	s

Note

T_{amb} = 25 °C, unless otherwise specified.

Stresses in excess of the absolute maximum ratings can cause permanent damage to the device. Functional operation of the device is not implied at these or any other conditions in excess of those given in the operational sections of this document. Exposure to absolute maximum ratings for extended periods of the time can adversely affect reliability.

ELECTRICAL CHARACTERISTICS							
PARAMETER	TEST CONDITION	PART	SYMBOL	MIN.	TYP.	MAX.	UNIT
INPUT							
Forward voltage	I _F = 1.0 mA		V _F		1.0	1.5	V
Reverse current	V _R = 6 V		I _R		0.1	100	μA
Capacitance	V _R = 0 V, f = 1.0 MHz		C _O		25		pF
OUTPUT							
Collector emitter breakdown voltage	I _C = 100 μA		BV _{CEO}	30			V
Emitter collector breakdown voltage	I _E = 100 μA		BV _{ECO}	5.0			V
Emitter emitter breakdown voltage	I _C = 10 μA		BV _{CBO}	70			V
Collector emitter capacitance	V _{CE} = 10 V		C _{CE}		3.4		pF
COUPLER							
Saturation voltage, collector emitter	I _{CE} = 0.5 mA		V _{CEsat}			1.0	V
Capacitance (input to output)			C _{IO}		0.5		pF
Resistance (input to output)			R _{IO}		100		GΩ

Note

T_{amb} = 25 °C, unless otherwise specified.

Minimum and maximum values are tested requirements. Typical values are characteristics of the device and are the result of engineering evaluations. Typical values are for information only and are not part of the testing requirements.

CURRENT TRANSFER RATIO							
PARAMETER	TEST CONDITION	PART	SYMBOL	MIN.	TYP.	MAX.	UNIT
Current transfer ratio	I _F = 1.0 mA, V _{CE} = 5.0 V	IL221AT	CTR _{DC}	100			%
		IL222AT	CTR _{DC}	200			%
		IL223AT	CTR _{DC}	500			%

SAFETY AND INSULATION RATINGS						
PARAMETER	TEST CONDITION	SYMBOL	MIN.	TYP.	MAX.	UNIT
Climatic classification (according to IEC 68 part 1)				55/100/21		
Comparative tracking index		CTI	175		399	
V _{IOTM}			6000			V
V _{IORM}			560			V
P _{SO}					350	mW
I _{SI}					150	mA

SAFETY AND INSULATION RATINGS						
PARAMETER	TEST CONDITION	SYMBOL	MIN.	TYP.	MAX.	UNIT
T_{SI}					165	°C
Creepage distance			4			mm
Clearance distance			4			mm
Insulation thickness, reinforced rated	per IEC 60950 2.10.5.1		0.2			mm

Note

As per IEC 60747-5-2, § 7.4.3.8.1, this optocoupler is suitable for “safe electrical insulation” only within the safety ratings. Compliance with the safety ratings shall be ensured by means of protective circuits.

TYPICAL CHARACTERISTICS

$T_{amb} = 25\text{ °C}$, unless otherwise specified

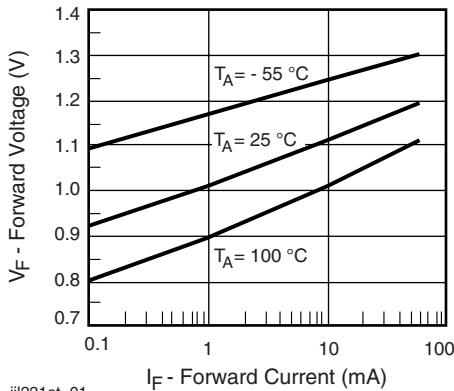

Fig. 1 - Forward Voltage vs. Forward Current

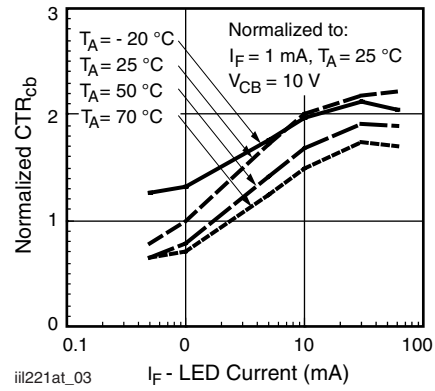

Fig. 3 - Normalized CTR_{cb} vs. I_F

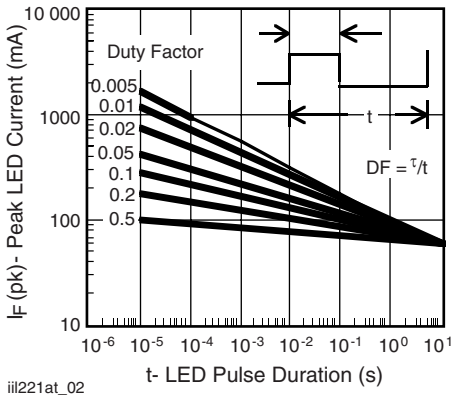

Fig. 2 - Peak LED Current vs. Duty Factor, τ

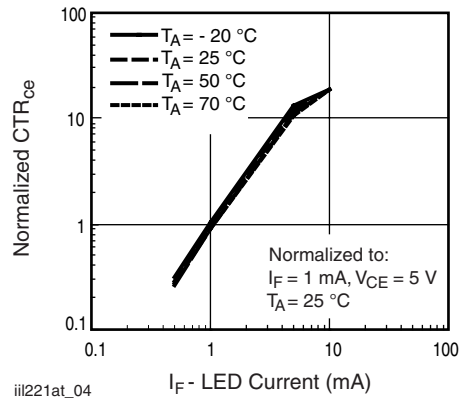

Fig. 4 - Normalized CTR_{ce} vs. LED Current

Optocoupler, Photodarlington Output, Vishay Semiconductors Low Input Current, High Gain, with Base Connection

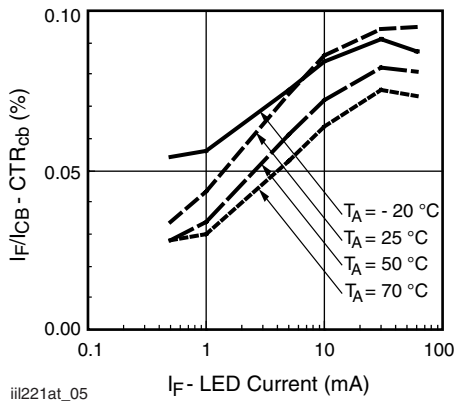

Fig. 5 - CTR_{CE} vs. LED Current

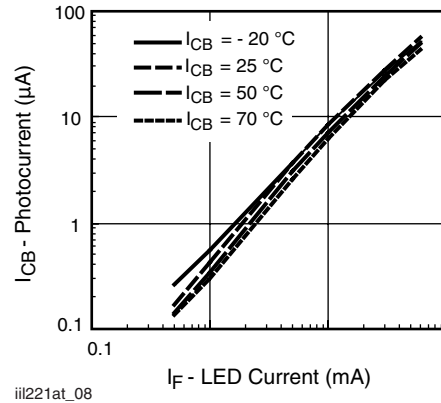

Fig. 8 - Photocurrent vs. LED Current

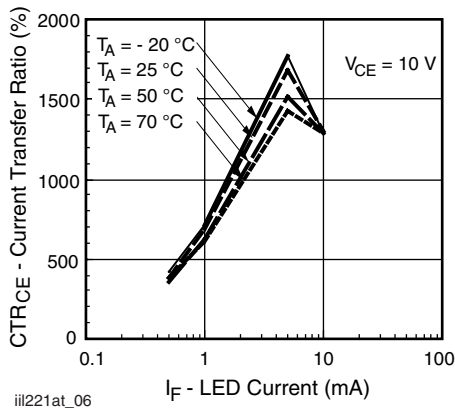

Fig. 6 - CTR vs. LED Current

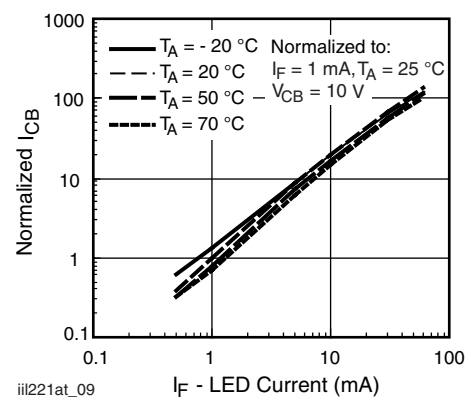

Fig. 9 - Normalized I_{CB} vs. I_F

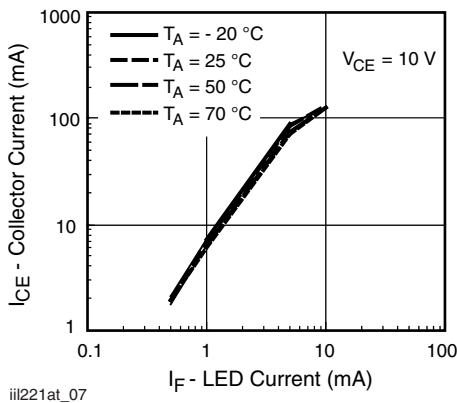

Fig. 7 - Collector Current vs. LED Current

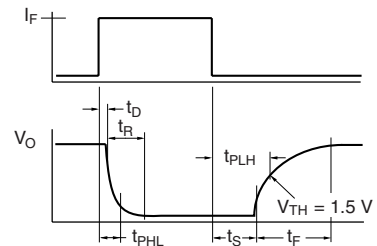
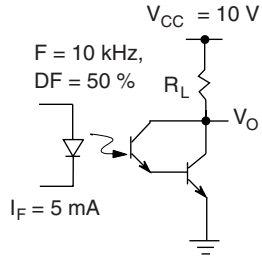

Fig. 10 - Switching Timing

IL221AT/222AT/223AT



Vishay Semiconductors Optocoupler, Photodarlington Output,
Low Input Current, High Gain, with Base
Connection



iii221at_11

Fig. 11 - Switching Schematic

PACKAGE DIMENSIONS in inches (millimeters)

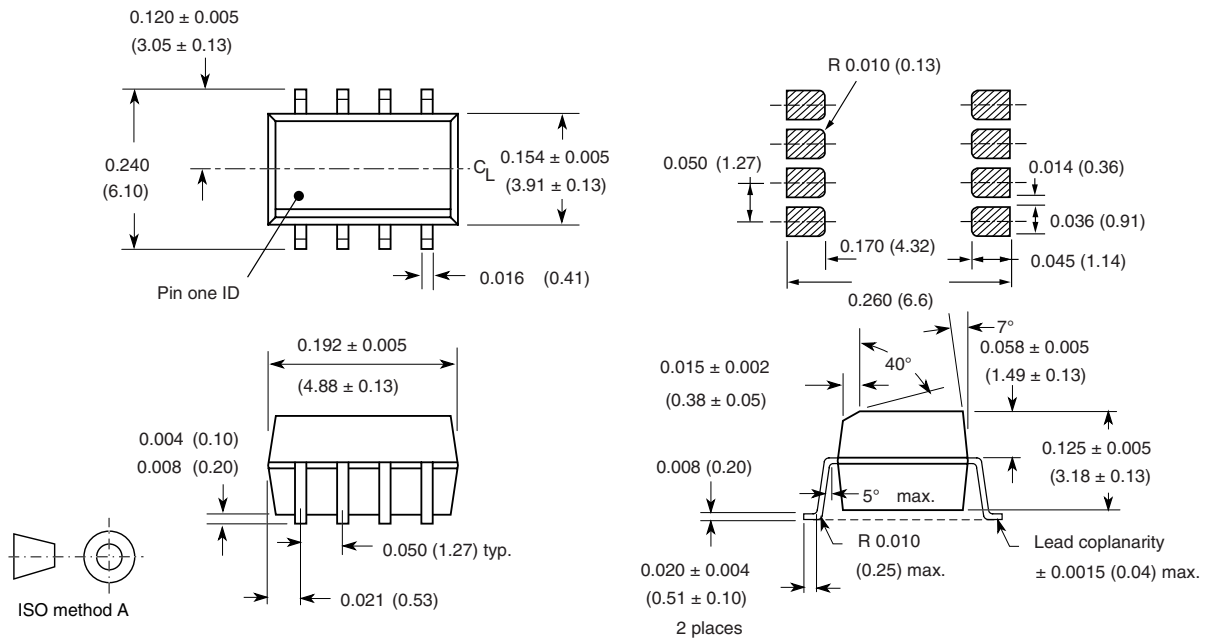

i178003



Optocoupler, Photodarlington Output, Vishay Semiconductors
Low Input Current, High Gain, with Base
Connection

OZONE DEPLETING SUBSTANCES POLICY STATEMENT

It is the policy of Vishay Semiconductor GmbH to

1. Meet all present and future national and international statutory requirements.
2. Regularly and continuously improve the performance of our products, processes, distribution and operating systems with respect to their impact on the health and safety of our employees and the public, as well as their impact on the environment.

It is particular concern to control or eliminate releases of those substances into the atmosphere which are known as ozone depleting substances (ODSs).

The Montreal Protocol (1987) and its London Amendments (1990) intend to severely restrict the use of ODSs and forbid their use within the next ten years. Various national and international initiatives are pressing for an earlier ban on these substances.

Vishay Semiconductor GmbH has been able to use its policy of continuous improvements to eliminate the use of ODSs listed in the following documents.

1. Annex A, B and list of transitional substances of the Montreal Protocol and the London Amendments respectively.
2. Class I and II ozone depleting substances in the Clean Air Act Amendments of 1990 by the Environmental Protection Agency (EPA) in the USA.
3. Council Decision 88/540/EEC and 91/690/EEC Annex A, B and C (transitional substances) respectively.

Vishay Semiconductor GmbH can certify that our semiconductors are not manufactured with ozone depleting substances and do not contain such substances.

We reserve the right to make changes to improve technical design
and may do so without further notice.

Parameters can vary in different applications. All operating parameters must be validated for each customer application by the customer. Should the buyer use Vishay Semiconductors products for any unintended or unauthorized application, the buyer shall indemnify Vishay Semiconductors against all claims, costs, damages, and expenses, arising out of, directly or indirectly, any claim of personal damage, injury or death associated with such unintended or unauthorized use.

Vishay Semiconductor GmbH, P.O.B. 3535, D-74025 Heilbronn, Germany



Disclaimer

ALL PRODUCT, PRODUCT SPECIFICATIONS AND DATA ARE SUBJECT TO CHANGE WITHOUT NOTICE TO IMPROVE RELIABILITY, FUNCTION OR DESIGN OR OTHERWISE.

Vishay Intertechnology, Inc., its affiliates, agents, and employees, and all persons acting on its or their behalf (collectively, "Vishay"), disclaim any and all liability for any errors, inaccuracies or incompleteness contained in any datasheet or in any other disclosure relating to any product.

Vishay makes no warranty, representation or guarantee regarding the suitability of the products for any particular purpose or the continuing production of any product. To the maximum extent permitted by applicable law, Vishay disclaims (i) any and all liability arising out of the application or use of any product, (ii) any and all liability, including without limitation special, consequential or incidental damages, and (iii) any and all implied warranties, including warranties of fitness for particular purpose, non-infringement and merchantability.

Statements regarding the suitability of products for certain types of applications are based on Vishay's knowledge of typical requirements that are often placed on Vishay products in generic applications. Such statements are not binding statements about the suitability of products for a particular application. It is the customer's responsibility to validate that a particular product with the properties described in the product specification is suitable for use in a particular application. Parameters provided in datasheets and / or specifications may vary in different applications and performance may vary over time. All operating parameters, including typical parameters, must be validated for each customer application by the customer's technical experts. Product specifications do not expand or otherwise modify Vishay's terms and conditions of purchase, including but not limited to the warranty expressed therein.

Hyperlinks included in this datasheet may direct users to third-party websites. These links are provided as a convenience and for informational purposes only. Inclusion of these hyperlinks does not constitute an endorsement or an approval by Vishay of any of the products, services or opinions of the corporation, organization or individual associated with the third-party website. Vishay disclaims any and all liability and bears no responsibility for the accuracy, legality or content of the third-party website or for that of subsequent links.

Except as expressly indicated in writing, Vishay products are not designed for use in medical, life-saving, or life-sustaining applications or for any other application in which the failure of the Vishay product could result in personal injury or death. Customers using or selling Vishay products not expressly indicated for use in such applications do so at their own risk. Please contact authorized Vishay personnel to obtain written terms and conditions regarding products designed for such applications.

No license, express or implied, by estoppel or otherwise, to any intellectual property rights is granted by this document or by any conduct of Vishay. Product names and markings noted herein may be trademarks of their respective owners.

单击下面可查看定价，库存，交付和生命周期等信息

[>>Vishay\(威世\)](#)