

N-Channel JFETs

PRODUCT SUMMARY				
Part Number	$V_{GS(off)}$ (V)	$r_{DS(on)}$ Max (Ω)	$I_{D(off)}$ Typ (μ A)	t_{ON} Typ (ns)
U290	-4.0 to -10	3	10	14
U291	-1.5 to -4.5	7	10	14

FEATURES

- Low On-Resistance: U290 < 3 Ω
- Fast Switching— t_{ON} : 14 ns
- High Off-Isolation
- Low Capacitance: 20 pF
- Low Insertion Loss

BENEFITS

- Low Error Voltage
- High-Speed Analog Circuit Performance
- Negligible "Off-Error," Excellent Accuracy
- Good Frequency Response
- Eliminates Additional Buffering

APPLICATIONS

- Analog Switches
- Choppers
- Sample-and-Hold
- Normally "On" Switches
- Current Limiters

DESCRIPTION

The U290/U291 are high-performance JFET analog switches designed to offer low on-resistance and fast switching. This series features the lowest on-resistance of any JFET in the industry today.

For similar products in TO-226A (TO-92) packaging, see the J105/106/107 data sheet.

The TO-206AC (TO-52) hermetically sealed case makes this series suitable for military applications.

Ordering Information: U290—E3
U291—E3

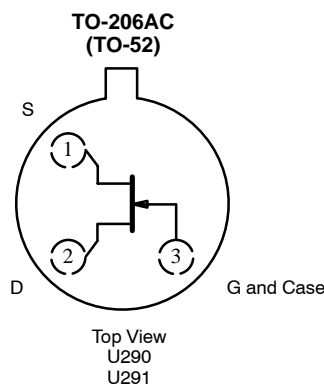

ABSOLUTE MAXIMUM RATINGS

Gate-Drain, Gate-Source Voltage -30 V
 Gate Current 100 mA
 Storage Temperature -65 to 200°C
 Operating Junction Temperature -55 to 150°C

Power Dissipation^a 500 mW

Notes
 a. Derate 4 mW/°C above 25°C



SPECIFICATIONS (T _A = 25 °C UNLESS OTHERWISE NOTED)								
Parameter	Symbol	Test Conditions	Typ ^a	Limits				Unit
				U290		U291		
				Min	Max	Min	Max	
Static								
Gate-Source Breakdown Voltage	V _{(BR)GSS}	I _G = -1 μA, V _{DS} = 0 V	-35	-30		-30		V
Gate-Source Cutoff Voltage	V _{GS(off)}	V _{DS} = 15 V, I _D = 3 nA		-4.0	-10	-1.5	-4.5	
Saturation Drain Current ^b	I _{DSS}	V _{DS} = 10 V, V _{GS} = 0 V		500		200		mA
Gate Reverse Current	I _{GSS}	V _{GS} = -15 V, V _{DS} = 0 V	-0.02		-1		-1	nA
		T _A = 125 °C	-0.01		-1		-1	μA
Gate Operating Current ^b	I _G	V _{DG} = 10 V, I _D = 25 mA	-0.01					nA
Drain Cutoff Current	I _{D(off)}	V _{DS} = 5 V, V _{GS} = -10 V	0.01		1		1	μA
		T _A = 125 °C	-0.005		1		1	μA
Drain-Source On-Resistance	r _{DS(on)}	V _{GS} = 0 V, I _D = 1 mA			3		7	Ω
Gate-Source Forward Voltage	V _{GS(F)}	I _G = 1 mA, V _{DS} = 0 V	0.7					V
Dynamic								
Common-Source Forward Transconductance ^b	g _{fs}	V _{DS} = 10 V, I _D = 25 mA, f = 1 kHz	55					mS
Common-Source Output Conductance ^b	g _{os}		5					
Drain-Source On-Resistance	r _{ds(on)}	V _{GS} = 0 V, I _D = 1 mA, f = 1 kHz			3		7	Ω
Common-Source Input Capacitance	C _{iss}	V _{DS} = 0 V, V _{GS} = 0 V, f = 1 MHz	120		160		160	pF
Common-Source Reverse Transfer Capacitance	C _{rss}	V _{DS} = 0 V, V _{GS} = -15 V, f = 1 MHz	20		30		30	
Equivalent Input Noise Voltage	e _n	V _{DG} = 10 V, I _D = 25 mA, f = 1 kHz	3					nV/√Hz
Switching								
Turn-On Time	t _{d(on)}	V _{DD} = 1.5 V, V _{GS(H)} = 0 V See Switching Diagram	6		15		15	ns
	t _r		8		20		20	
Turn-Off Time	t _{d(off)}		5		15		15	
	t _f		9		20		20	

Notes

- a. Typical values are for DESIGN AID ONLY, not guaranteed nor subject to production testing.
- b. Pulse test: PW ≤ 300 μs duty cycle ≤ 3%.

NVA

TYPICAL CHARACTERISTICS (T_A = 25 °C UNLESS OTHERWISE NOTED)

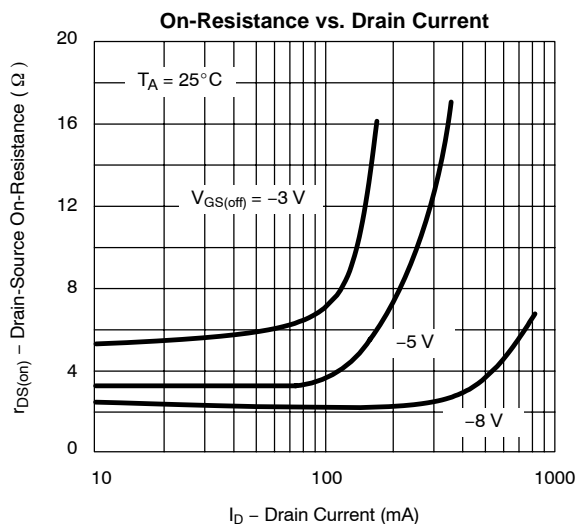
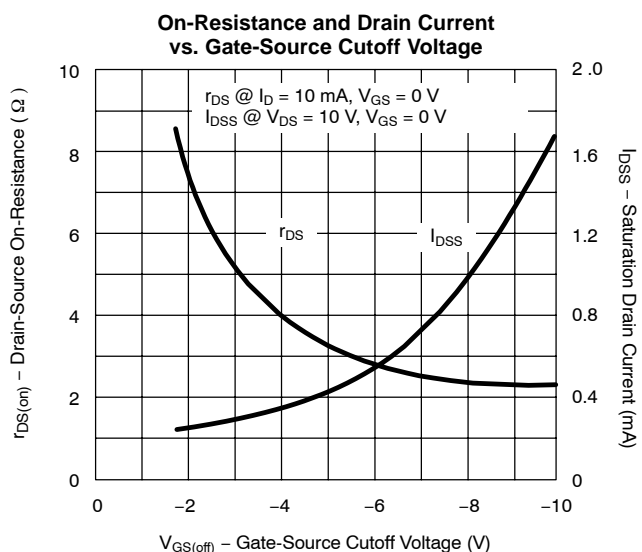



TYPICAL CHARACTERISTICS ($T_A = 25^\circ\text{C}$ UNLESS OTHERWISE NOTED)

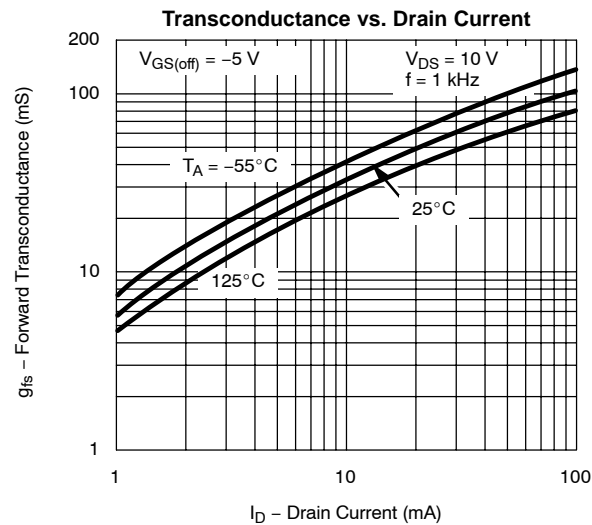
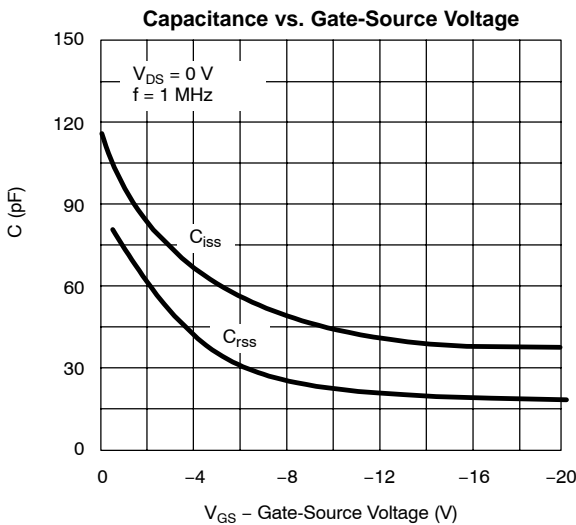
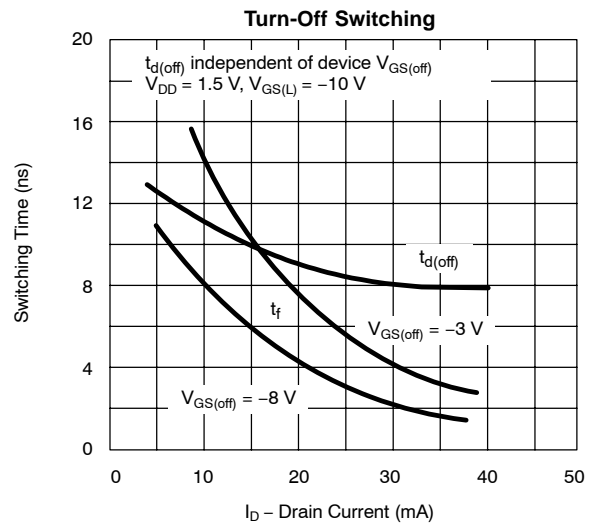
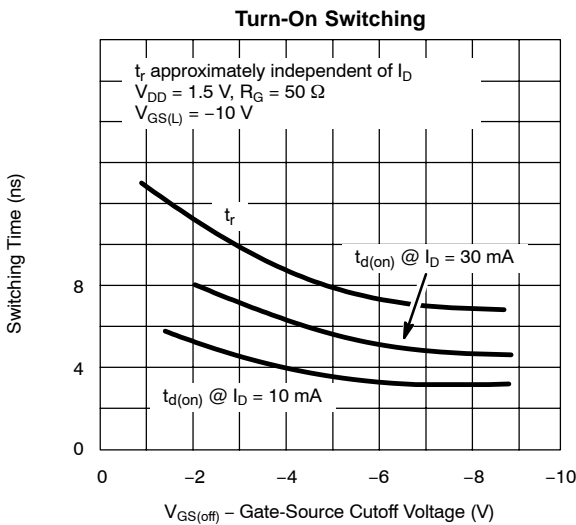
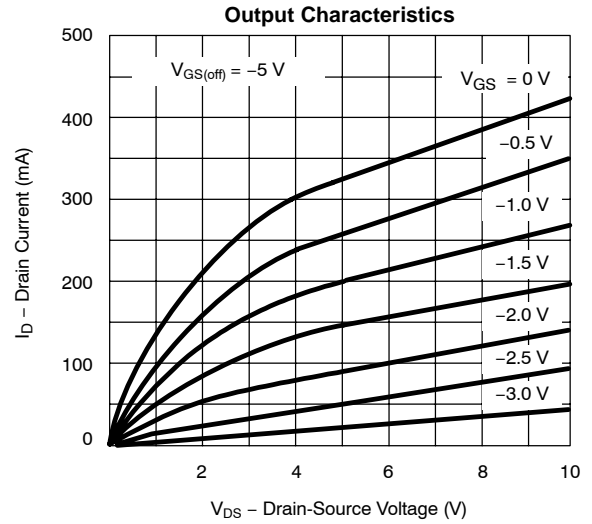
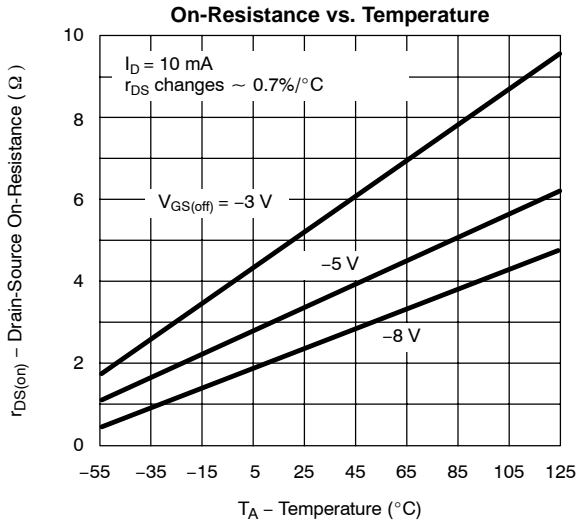

TYPICAL CHARACTERISTICS (T_A = 25°C UNLESS OTHERWISE NOTED)

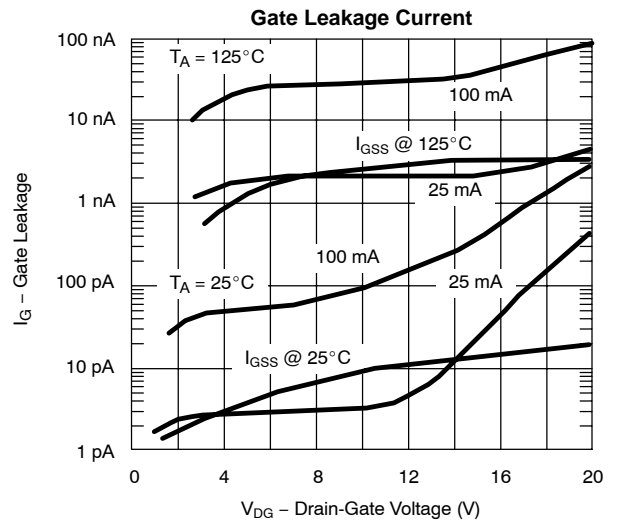
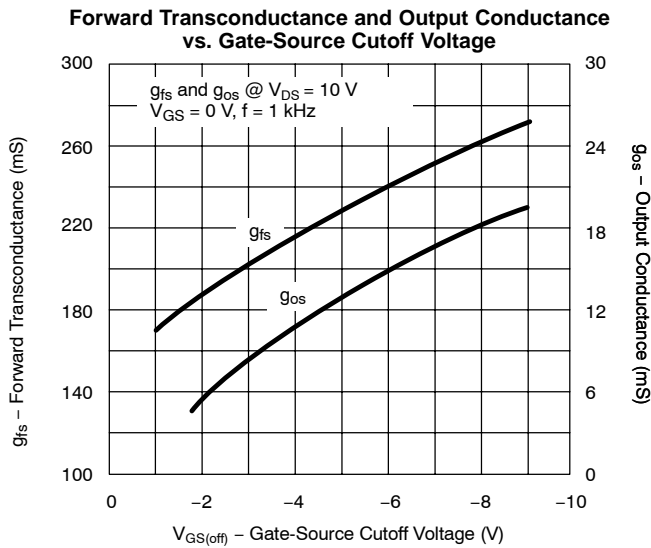
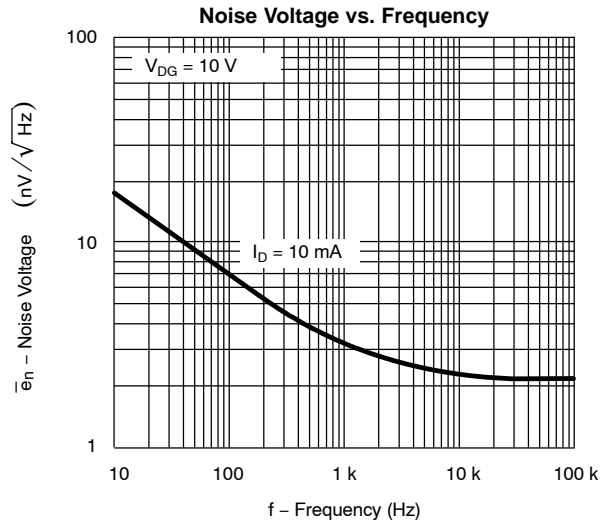
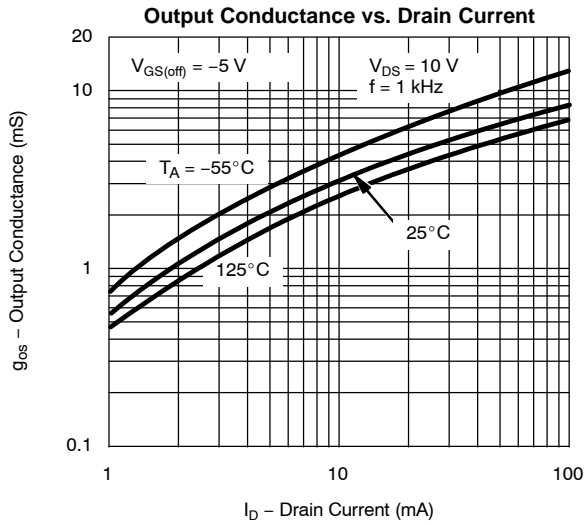

SWITCHING TIME TEST CIRCUIT		
	U290	U291
V _{GS(L)}	-12 V	-7 V
R _L *	50 Ω	50 Ω
I _{D(on)}	28 mA	27 mA

* Non-Inductive

Input Pulse

Rise Time < 1 ns
 Fall Time < 1 ns
 Pulse Width 100 ns
 PRF 1 MHz

Sampling Scope

Rise Time 0.4 ns
 Input Resistance 10 MΩ
 Input Capacitance 1.5 pF

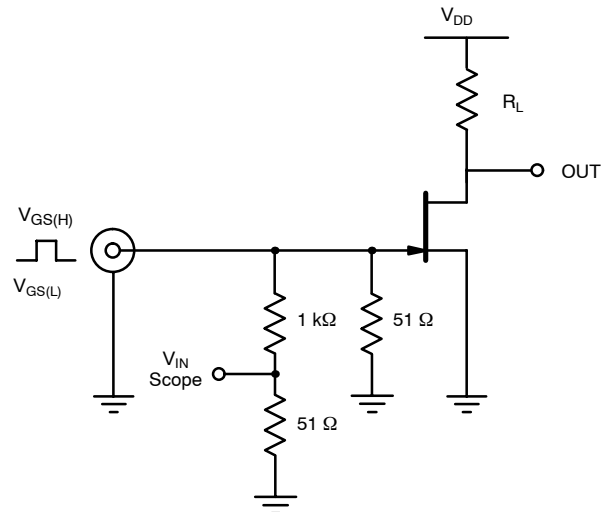



Disclaimer

All product specifications and data are subject to change without notice.

Vishay Intertechnology, Inc., its affiliates, agents, and employees, and all persons acting on its or their behalf (collectively, "Vishay"), disclaim any and all liability for any errors, inaccuracies or incompleteness contained herein or in any other disclosure relating to any product.

Vishay disclaims any and all liability arising out of the use or application of any product described herein or of any information provided herein to the maximum extent permitted by law. The product specifications do not expand or otherwise modify Vishay's terms and conditions of purchase, including but not limited to the warranty expressed therein, which apply to these products.

No license, express or implied, by estoppel or otherwise, to any intellectual property rights is granted by this document or by any conduct of Vishay.

The products shown herein are not designed for use in medical, life-saving, or life-sustaining applications unless otherwise expressly indicated. Customers using or selling Vishay products not expressly indicated for use in such applications do so entirely at their own risk and agree to fully indemnify Vishay for any damages arising or resulting from such use or sale. Please contact authorized Vishay personnel to obtain written terms and conditions regarding products designed for such applications.

Product names and markings noted herein may be trademarks of their respective owners.

单击下面可查看定价，库存，交付和生命周期等信息

[>>Vishay\(威世\)](#)