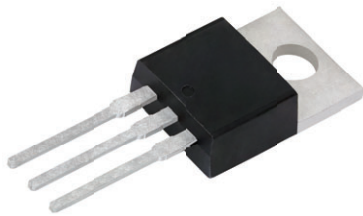
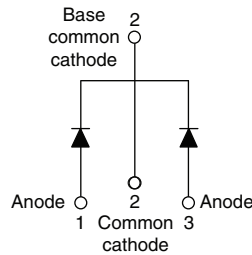

## High Performance Schottky Rectifier, 2 x 20 A

**3L TO-220AB**

### FEATURES

- 150 °C  $T_J$  operation
- Low forward voltage drop
- High frequency operation
- High purity, high temperature epoxy encapsulation for enhanced mechanical strength and moisture resistance
- Guard ring for enhanced ruggedness and long term reliability
- Designed and qualified according to JEDEC®-JESD 47
- Material categorization: for definitions of compliance please see [www.vishay.com/doc?99912](http://www.vishay.com/doc?99912)

**RoHS**  
 COMPLIANT  
 HALOGEN  
**FREE**

### DESCRIPTION

This center tap Schottky rectifier has been optimized for low reverse leakage at high temperature. The proprietary barrier technology allows for reliable operation up to 150 °C junction temperature. Typical applications are in switching power supplies, converters, freewheeling diodes, and reverse battery protection.

PRIMARY CHARACTERISTICS	
$I_{F(AV)}$	2 x 20 A
$V_R$	45 V
$V_F$ at $I_F$	0.58 V
$I_{RM}$ max.	95 mA at 125 °C
$T_J$ max.	150 °C
$E_{AS}$	20 mJ
Package	3L TO-220AB
Circuit configuration	Common cathode

MAJOR RATINGS AND CHARACTERISTICS			
SYMBOL	CHARACTERISTICS	VALUES	UNITS
$I_{F(AV)}$	Rectangular waveform (per device)	40	A
$V_{RRM}$		45	V
$I_{FRM}$	$T_C = 118$ °C (per leg)	40	A
$I_{FSM}$	$t_p = 5$ $\mu$ s sine	900	
$V_F$	20 $A_{pk}$ , $T_J = 125$ °C	0.58	V
$T_J$	Range	-65 to +150	°C

VOLTAGE RATINGS			
PARAMETER	SYMBOL	VS-MBR4045CT-M3	UNITS
Maximum DC reverse voltage	$V_R$	45	V
Maximum working peak reverse voltage	$V_{RWM}$		

ABSOLUTE MAXIMUM RATINGS				
PARAMETER	SYMBOL	TEST CONDITIONS	VALUES	UNITS
Maximum average forward current per leg per device	$I_{F(AV)}$	$T_C = 118$ °C, rated $V_R$	20	A
			40	
Peak repetitive forward current per leg	$I_{FRM}$	Rated $V_R$ , square wave, 20 kHz, $T_C = 118$ °C	40	
Maximum peak one cycle non-repetitive surge current per leg	$I_{FSM}$	5 $\mu$ s sine or 3 $\mu$ s rect. pulse	900	
		10 ms sine or 6 ms rect. pulse	210	
Non-repetitive avalanche energy per leg	$E_{AS}$	$T_J = 25$ °C, $I_{AS} = 3$ A, $L = 4.40$ mH	20	mJ
Repetitive avalanche current per leg	$I_{AR}$	Current decaying linearly to zero in 1 $\mu$ s Frequency limited by $T_J$ maximum $V_A = 1.5 \times V_R$ typical	3	A



ELECTRICAL SPECIFICATIONS					
PARAMETER	SYMBOL	TEST CONDITIONS		VALUES	UNITS
Maximum forward voltage drop	$V_{FM}^{(1)}$	20 A	$T_J = 25\text{ }^\circ\text{C}$	0.60	V
		40 A		0.78	
		20 A	$T_J = 125\text{ }^\circ\text{C}$	0.58	
		40 A		0.75	
Maximum instantaneous reverse current	$I_{RM}^{(1)}$	$T_J = 25\text{ }^\circ\text{C}$	Rated DC voltage	1	mA
		$T_J = 100\text{ }^\circ\text{C}$		50	
		$T_J = 125\text{ }^\circ\text{C}$		95	
Maximum junction capacitance	$C_T$	$V_R = 5\text{ }V_{DC}$ , (test signal range 100 kHz to 1 MHz) 25 °C		900	pF
Typical series inductance	$L_S$	Measured from top of terminal to mounting plane		8.0	nH
Maximum voltage rate of change	dV/dt	Rated $V_R$		10 000	V/ $\mu$ s

**Note**(1) Pulse width < 300  $\mu$ s, duty cycle < 2 %

THERMAL - MECHANICAL SPECIFICATIONS					
PARAMETER	SYMBOL	TEST CONDITIONS		VALUES	UNITS
Maximum junction temperature range	$T_J$			-65 to +150	°C
Maximum storage temperature range	$T_{Stg}$			-65 to +175	
Maximum thermal resistance, junction to case per leg	$R_{thJC}$	DC operation		1.5	°C/W
Typical thermal resistance, case to heatsink	$R_{thCS}$	Mounting surface, smooth and greased (Only for TO-220)		0.50	
Maximum thermal resistance, junction to ambient	$R_{thJA}$	DC operation (For D <sup>2</sup> PAK and TO-262)		50	
Approximate weight				2	g
				0.07	oz.
Mounting torque	minimum maximum		Non-lubricated threads	6 (5)	kgf · cm (lbf · in)
				12 (10)	
Marking device		Case style 3L TO-220AB		MBR4045CT	

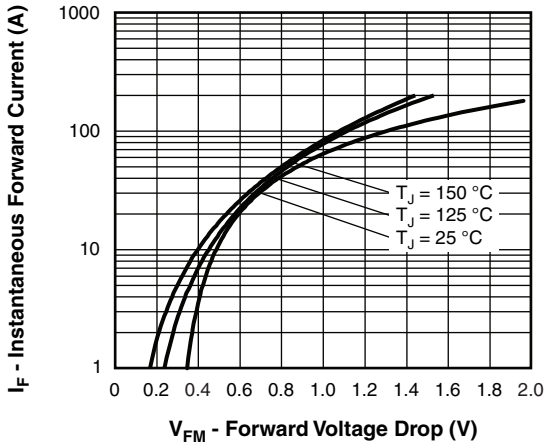

Fig. 1 - Maximum Forward Voltage Drop Characteristics (Per Leg)

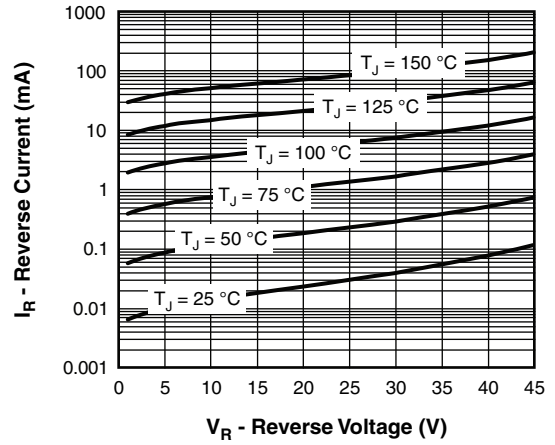

Fig. 2 - Typical Values of Reverse Current vs. Reverse Voltage (Per Leg)

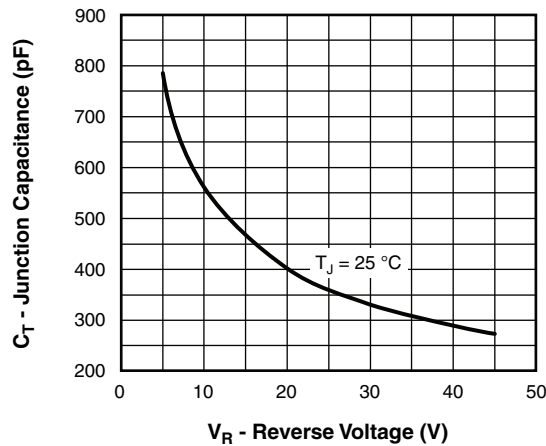

Fig. 3 - Typical Junction Capacitance vs. Reverse Voltage (Per Leg)

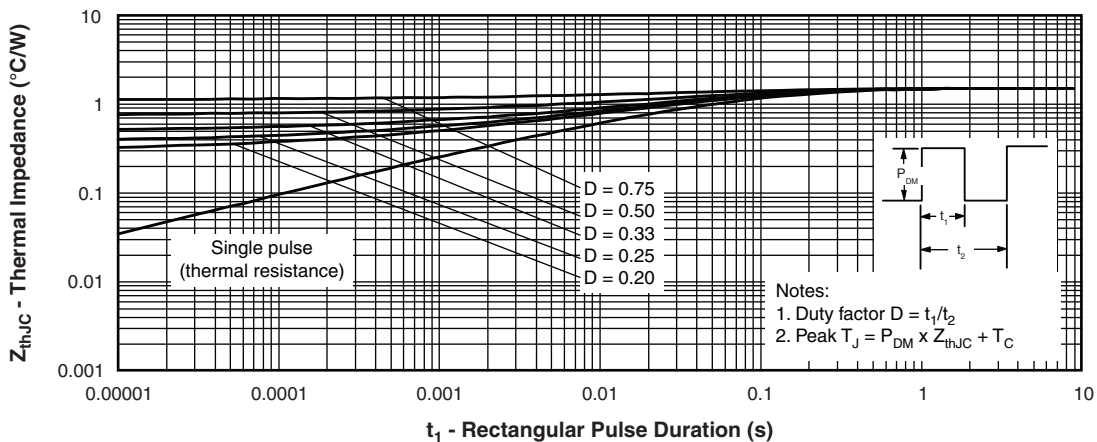

Fig. 4 - Maximum Thermal Impedance  $Z_{thJC}$  Characteristics (Per Leg)

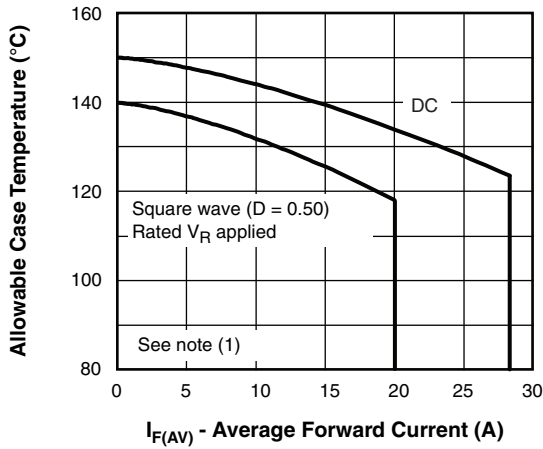

Fig. 5 - Maximum Allowable Case Temperature vs. Average Forward Current

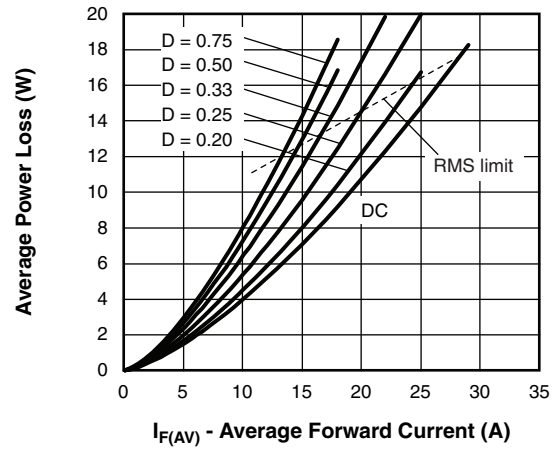

Fig. 6 - Forward Power Loss Characteristics

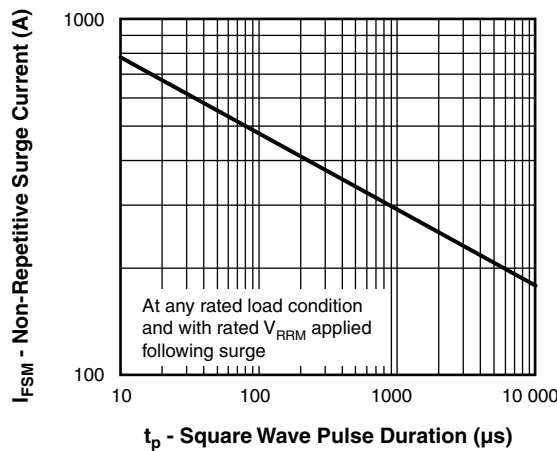

Fig. 7 - Maximum Non-Repetitive Surge Current (Per Leg)

**Note**

- (1) Formula used:  $T_C = T_J - (P_d + P_{d_{REV}}) \times R_{thJC}$ ;  
 $P_d$  = forward power loss =  $I_{F(AV)} \times V_{FM}$  at  $(I_{F(AV)}/D)$  (see fig. 6);  
 $P_{d_{REV}}$  = inverse power loss =  $V_{R1} \times I_R (1 - D)$ ;  $I_R$  at  $V_{R1}$  = rated  $V_R$



ORDERING INFORMATION TABLE

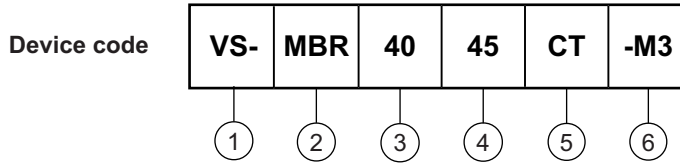

- 1** - Vishay Semiconductors product
  - 2** - Schottky MBR series
  - 3** - Current rating (40 = 40 A)
  - 4** - Voltage rating (45 = 45 V)
  - 5** - CT = essential part number
  - 6** - Environmental digit
- M3 = halogen-free, RoHS-compliant, and terminations lead (Pb)-free

ORDERING INFORMATION (Example)			
PREFERRED P/N	QUANTITY PER T/R	MINIMUM ORDER QUANTITY	PACKAGING DESCRIPTION
VS-MBR4045CT-M3	50	1000	Antistatic plastic tube

LINKS TO RELATED DOCUMENTS	
Dimensions	<a href="http://www.vishay.com/doc?96154">www.vishay.com/doc?96154</a>
Part marking information	<a href="http://www.vishay.com/doc?95028">www.vishay.com/doc?95028</a>
SPICE model	<a href="http://www.vishay.com/doc?95296">www.vishay.com/doc?95296</a>



### 3L TO-220AB

**DIMENSIONS** in millimeters and inches

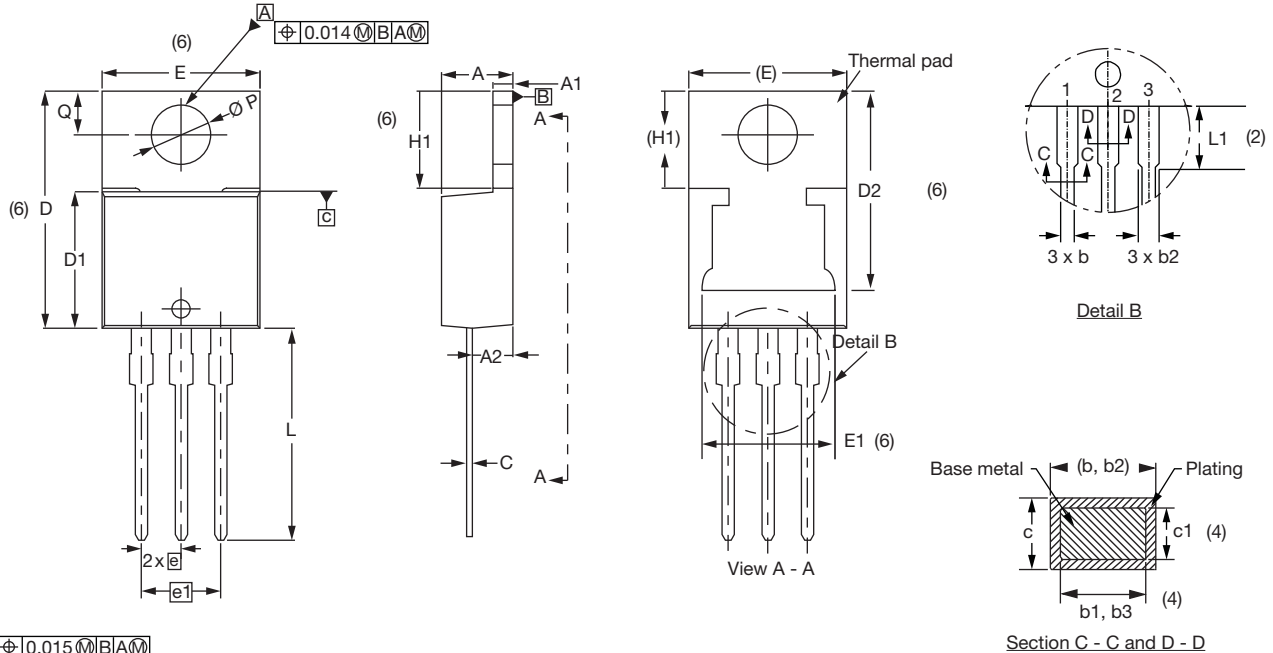

Conforms to JEDEC® outline TO-220AB

SYMBOL	MILLIMETERS		INCHES		NOTES	SYMBOL	MILLIMETERS		INCHES		NOTES
	MIN.	MAX.	MIN.	MAX.			MIN.	MAX.	MIN.	MAX.	
A	4.25	4.65	0.167	0.183		D2	11.68	13.30	0.460	0.524	6, 7
A1	1.14	1.40	0.045	0.055		E	10.11	10.51	0.398	0.414	3, 6
A2	2.50	2.92	0.098	0.115		E1	6.86	8.89	0.270	0.350	6
b	0.69	1.01	0.027	0.040		e	2.41	2.67	0.095	0.105	
b1	0.38	0.97	0.015	0.038	4	e1	4.88	5.28	0.192	0.208	
b2	1.20	1.73	0.047	0.068		H1	6.09	6.48	0.240	0.255	6
b3	1.14	1.73	0.045	0.068	4	L	13.52	14.02	0.532	0.552	
c	0.36	0.61	0.014	0.024		L1	3.32	3.82	0.131	0.150	2
c1	0.36	0.56	0.014	0.022	4	∅ P	3.54	3.91	0.139	0.154	
D	14.85	15.35	0.585	0.604	3	Q	2.60	3.00	0.102	0.118	
D1	8.38	9.02	0.330	0.355							

**Notes**

- (1) Dimensioning and tolerancing as per ASME Y14.5M-1994
- (2) Lead dimension and finish uncontrolled in L1
- (3) Dimension D, D1, and E do not include mold flash. Mold flash shall not exceed 0.127 mm (0.005") per side. These dimensions are measured at the outermost extremes of the plastic body
- (4) Dimension b1, b3, and c1 apply to base metal only
- (5) Controlling dimensions: inches
- (6) Thermal pad contour optional within dimensions E, H1, D2, and E1
- (7) Outline conforms to JEDEC® TO-220, except D2



## Disclaimer

ALL PRODUCT, PRODUCT SPECIFICATIONS AND DATA ARE SUBJECT TO CHANGE WITHOUT NOTICE TO IMPROVE RELIABILITY, FUNCTION OR DESIGN OR OTHERWISE.

Vishay Intertechnology, Inc., its affiliates, agents, and employees, and all persons acting on its or their behalf (collectively, "Vishay"), disclaim any and all liability for any errors, inaccuracies or incompleteness contained in any datasheet or in any other disclosure relating to any product.

Vishay makes no warranty, representation or guarantee regarding the suitability of the products for any particular purpose or the continuing production of any product. To the maximum extent permitted by applicable law, Vishay disclaims (i) any and all liability arising out of the application or use of any product, (ii) any and all liability, including without limitation special, consequential or incidental damages, and (iii) any and all implied warranties, including warranties of fitness for particular purpose, non-infringement and merchantability.

Statements regarding the suitability of products for certain types of applications are based on Vishay's knowledge of typical requirements that are often placed on Vishay products in generic applications. Such statements are not binding statements about the suitability of products for a particular application. It is the customer's responsibility to validate that a particular product with the properties described in the product specification is suitable for use in a particular application. Parameters provided in datasheets and / or specifications may vary in different applications and performance may vary over time. All operating parameters, including typical parameters, must be validated for each customer application by the customer's technical experts. Product specifications do not expand or otherwise modify Vishay's terms and conditions of purchase, including but not limited to the warranty expressed therein.

Hyperlinks included in this datasheet may direct users to third-party websites. These links are provided as a convenience and for informational purposes only. Inclusion of these hyperlinks does not constitute an endorsement or an approval by Vishay of any of the products, services or opinions of the corporation, organization or individual associated with the third-party website. Vishay disclaims any and all liability and bears no responsibility for the accuracy, legality or content of the third-party website or for that of subsequent links.

Except as expressly indicated in writing, Vishay products are not designed for use in medical, life-saving, or life-sustaining applications or for any other application in which the failure of the Vishay product could result in personal injury or death. Customers using or selling Vishay products not expressly indicated for use in such applications do so at their own risk. Please contact authorized Vishay personnel to obtain written terms and conditions regarding products designed for such applications.

No license, express or implied, by estoppel or otherwise, to any intellectual property rights is granted by this document or by any conduct of Vishay. Product names and markings noted herein may be trademarks of their respective owners.

单击下面可查看定价，库存，交付和生命周期等信息

[>>Vishay\(威世\)](#)