

Interference Suppression Film Capacitor - Class Y2 Radial MKP 300 V_{AC} - Line to Ground Application

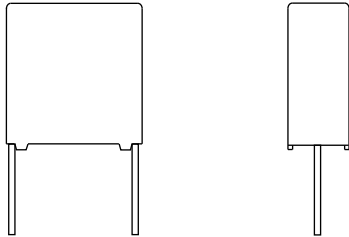

FEATURES



- AEC-Q200 qualified (rev. C)
- Robust design
- Material categorization:
for definitions of compliance please see
www.vishay.com/doc?99912

 AUTOMOTIVE
GRADE

RoHS
COMPLIANT

APPLICATIONS

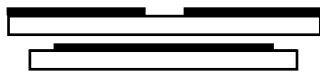
- Standard line bypass (between line and ground) Y2 applications
 - Line bypass application for continuous operation
- See also application note: www.vishay.com/doc?28153

QUICK REFERENCE DATA	
Capacitance range (E12 series)	0.001 μ F to 0.47 μ F (preferred values acc. to E6)
Capacitance tolerance	$\pm 20\%$, $\pm 10\%$, $\pm 5\%$
Rated AC voltage	300 V _{AC} ; 50 Hz to 60 Hz
Permissible DC voltage	1000 V _{DC}
Climatic testing class acc. to IEC 60068-1	55/105/56/C for product volumes ≤ 1750 mm ³ 55/105/56/B for volumes > 1750 mm ³
Maximum application temperature	105 °C
Reference standards	IEC 60384-14 ed-4 (2013) and EN 60384-14 IEC 60065 requires pass. flamm. class B for volumes > 1750 mm ³ UL 60384-14 2 nd edition; ENEC; CSA E60384-1:14 3 rd edition
Dielectric	Polypropylene film
Electrodes	Metallized film
Construction	Series construction (for > 10 mm pitch)  Triple construction (for 7.5 mm and 10 mm pitch) 
Encapsulation	Plastic case, epoxy resin sealed, flame retardant class UL 94 V-0
Leads	Tinned wire
Marking	C-value; tolerance; rated voltage; sub-class; manufacturer's type designation; code for dielectric material; manufacturer location, year and week; manufacturer's logo or name; safety approvals

Note

- For more detailed data and test requirements, contact rfi@vishay.com

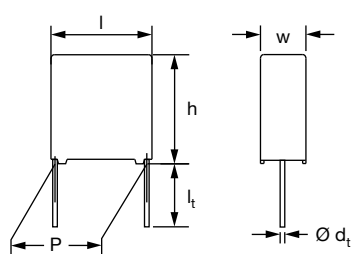
DIMENSIONS



COMPOSITION OF CATALOG NUMBER

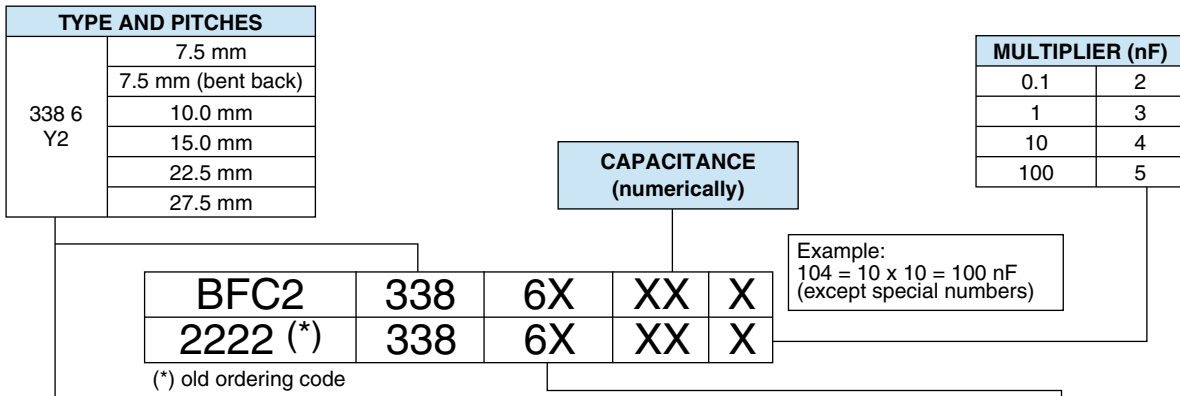

TYPE	PACKAGING	LEAD CONFIGURATION	C-TOL.	PREFERRED TYPES
338 6 Y2	Loose in box	Lead length 3.5 mm + 1 mm / - 0.5 mm (pitch 7.5 mm and 10 mm) Lead length 3.5 mm ± 0.3 mm (pitch > 10 mm)	± 20 %	BFC2 338 60...
		Lead length 5.0 mm ± 1.0 mm		BFC2 338 62...
		Lead length 25.0 mm ± 2.0 mm		BFC2 338 64...
	Taped ammo ⁽¹⁾	Pitch = 7.5 mm H = 18.5 mm; P ₀ = 12.7 mm		BFC2 338 66...
	Taped reel	Pitch 7.5 mm only to 15 mm; H = 18.5 mm		BFC2 338 68...
		ALTERNATIVE PITCH SIZES		ON REQUEST
338 6 Y2	Loose in box	Lead length 3.5 mm + 1 mm / - 0.5 mm (pitch 7.5 mm and 10 mm) Lead length 3.5 mm ± 0.3 mm (pitch > 10 mm)	± 20 %	See tables for detail
		Lead length 5.0 mm ± 1.0 mm		
		Lead length 25.0 mm ± 2.0 mm		
		ALTERNATIVE TAPED VERSIONS		ON REQUEST
338 6 Y2	Taped reel ⁽¹⁾	Pitch = 7.5 mm and 10.0 mm H = 18.5 mm; P ₀ = 12.7 mm; reel diameter = 500 mm	± 20 %	See tables for detail
		Pitch bent back to 7.5 mm H = 16.0 mm; P ₀ = 15.0 mm; reel diameter = 500 mm		
		ALTERNATIVE C-TOL.		ON REQUEST
338 6 Y2	Loose in box	Lead length 3.5 mm + 1 mm / - 0.5 mm (pitch 7.5 mm and 10 mm) Lead length 3.5 mm ± 0.3 mm (pitch > 10 mm)	± 10 %	See tables for detail
			± 5 %	
		Lead length 5.0 mm ± 1.0 mm	± 10 %	
		± 5 %		
	Lead length 25.0 mm ± 2.0 mm	± 10 %		
		± 5 %		
	Taped ammo ⁽¹⁾	Pitch = 7.5 mm H = 18.5 mm; P ₀ = 12.7 mm	± 10 %	
			± 5 %	
Taped reel ⁽¹⁾	Pitch bent back to 7.5 mm H = 16.0 mm; P ₀ = 15.0 mm; reel diameter = 500 mm	± 10 %		
	Pitch = 7.5 mm and 10 mm H = 18.5 mm; P ₀ = 12.7 mm; reel diameter = 500 mm	± 5 %		

Note

⁽¹⁾ For detailed tape specification refer to "Packaging Information" www.vishay.com/doc?28139



SPECIFIC REFERENCE DATA		
DESCRIPTION	VALUE	
Rated AC voltage (U_{RAC})	300 V	
Permissible DC voltage (U_{RDC})	1000 V	
Tangent of loss angle	at 1 kHz	at 10 kHz
$C \leq 470$ nF	$\leq 10 \times 10^{-4}$	$\leq 20 \times 10^{-4}$
Rated voltage pulse slope (dU/dt) _R at 420 V _{DC}	100 V/ μ s	
R between leads, for $C \leq 0.33$ μ F at 100 V; 1 min	$> 15\,000$ M Ω	
RC between leads, for $C > 0.33$ μ F at 100 V; 1 min	> 5000 s	
R between leads and case; 100 V; 1 min	$> 30\,000$ M Ω	
Withstanding (DC) voltage (cut off current 10 mA) ⁽¹⁾ ; rise time ≤ 1000 V/s	3400 V; 1 min	
Withstanding (AC) voltage between leads and case	2100 V; 1 min	
Maximum application temperature	105 °C	

Note

⁽¹⁾ See "Voltage Proof Test for Metalized Film Capacitors": www.vishay.com/doc?28169

ELECTRICAL DATA AND ORDERING INFORMATION - PITCH 7.5 mm												
U_{RAC} (V)	CAP. (μ F)	DIMENSIONS w x h x l (mm)	MASS (g) ⁽³⁾	CATALOG NUMBER BFC2 338 6X XXX AND PACKAGING								
				LOOSE IN BOX				AMMOPACK		REEL $\varnothing = 500$ mm ⁽¹⁾⁽²⁾		
				SHORT LEADS		LONG LEADS						
				$l_t = 3.5$ mm + 1 mm / - 0.5 mm	$l_t = 5.0$ mm ± 1.0 mm	SPQ	$l_t = 25.0$ mm ± 2.0 mm	SPQ	H = 18.5 mm; P ₀ = 12.7 mm	SPQ	H = 18.5 mm; P ₀ = 12.7 mm	SPQ
PITCH = 7.5 mm \pm 0.4 mm; $d_t = 0.50$ mm \pm 0.05 mm; C-TOL. = \pm 20 % ($U_{RDC} = 1000$ V)												
300	0.0010	4.0 x 9.0 x 10.0	0.4	60102	62102	1500	64102	1000	66102	1250	68129	
	0.0012			60122	62122		64122		66122		68131	
	0.0015			60152	62152		64152		66152		68132	
	0.0018			60182	62182		64182		66182		68133	
	0.0022			60222	62222		64222		66222		68134	
	0.0027			60272	62272		64272		66272		68135	
	0.0033	5.0 x 10.5 x 10.0	0.4	60332	62332	1000	64332	1250	66332	1000	68136	
	0.0039			60392	62392		64392		66392		68137	
	0.0047	6.0 x 11.5 x 10.0	0.8	60472	62472	750	64472	1000	66472	750	68138	
	0.0056			60562	62562		64562		66562		68139	
	PITCH = 7.5 mm \pm 0.4 mm; $d_t = 0.50$ mm \pm 0.05 mm; C-TOL. = \pm 10 % ($U_{RDC} = 1000$ V)											
	300	0.0010	4.0 x 9.0 x 10.0	0.4	61102	63102	1500	65102	1000	67102	1250	68179
0.0012		61122			63122	65122		67122		68181		
0.0015		61152			63152	65152		67152		68182		
0.0018		61182			63182	65182		67182		68183		
0.0022		61222			63222	65222		67222		68184		
0.0027		61272			63272	65272		67272		68185		
0.0033		5.0 x 10.5 x 10.0	0.4	61332	63332	1000	65332	1250	67332	1000	68186	
0.0039				61392	63392		65392		67392		68187	
0.0047		6.0 x 11.5 x 10.0	0.8	61472	63472	750	65472	1000	67472	750	68188	
0.0056				61562	63562		65562		67562		68189	
PITCH = 7.5 mm \pm 0.4 mm; $d_t = 0.50$ mm \pm 0.05 mm; C-TOL. = \pm 5 % ($U_{RDC} = 1000$ V)												
300		0.0010	4.0 x 9.0 x 10.0	0.4	68215	68225	1500	68235	1000	68335	1250	68346
	0.0012	68216			68226	68236		68336		68347		
	0.0015	68217			68227	68237		68337		68348		
	0.0018	68218			68228	68238		68338		68349		
	0.0022	68219			68229	68239		68339		68351		
	0.0027	68221			68231	68241		68341		68352		
	0.0033	5.0 x 10.5 x 10.0	0.4	68222	68232	1000	68242	1250	68342	1000	68353	
	0.0039			68223	68233		68243		68343		68354	
	0.0047	6.0 x 11.5 x 10.0	0.8	68224	68234	750	68244	1000	68344	750	68355	

Notes

• SPQ = Standard Packing Quantity

⁽¹⁾ H = in-tape height; P₀ = sprocket hole distance; for detailed specifications refer to packaging information: www.vishay.com/doc?28139

⁽²⁾ Reel diameter = 365 mm is available on request

⁽³⁾ Weight for short lead product only



ELECTRICAL DATA AND ORDERING INFORMATION - PITCH 10 mm												
U _{RAC} (V)	CAP. (μF)	DIMENSIONS w x h x l (mm)	MASS (g) ⁽³⁾	CATALOG NUMBER BFC2 338 6X XXX AND PACKAGING								
				LOOSE IN BOX					AMMOPACK		REEL Ø = 500 mm ⁽¹⁾⁽²⁾	
				SHORT LEADS			LONG LEADS					
				l _t = 3.5 mm + 1 mm / - 0.5 mm	l _t = 5.0 mm ± 1.0 mm	SPQ	l _t = 25.0 mm ± 2.0 mm	SPQ	H = 18.5 mm; P ₀ = 12.7 mm	SPQ	H = 18.5 mm; P ₀ = 12.7 mm	SPQ
PITCH = 10.0 mm ± 0.4 mm; d_t = 0.60 mm ± 0.06 mm; C-TOL. = ± 20 % (U_{RDC} = 1000 V)												
0.0010		4.0 x 10.0 x 12.5	0.6	68392	68401	1000	68409	1250			68418	1400
0.0012				68393	68402		68411				68419	
0.0015				68394	68403		68412				68421	
0.0018				68395	68404		68413				68422	
0.0022				68396	68405		68414				68423	
0.0027				68397	68406		68415				68424	
0.0033				68398	68407		68416				68425	
0.0039				68399	68408		68417				68426	
0.0047		5.0 x 11.0 x 12.5	0.82	68101	68106	1000	68112	1000			68141	1100
0.0056				68102	68107		68113				68142	
0.0068				68103	68108		68114				68143	
0.0082		6.0 x 12.0 x 12.5	1.1	68104	68109	750	68115	750			68144	900
0.010				68105	68111		68116				68145	
PITCH = 10.0 mm ± 0.4 mm; d_t = 0.60 mm ± 0.06 mm; C-TOL. = ± 10 % (U_{RDC} = 1000 V)												
0.0010		4.0 x 10.0 x 12.5	0.6	68436	68445	1000	68454	1250			68463	1400
0.0012				68437	68446		68455				68464	
0.0015				68438	68447		68456				68465	
0.0018				68439	68448		68457				68466	
0.0022				68441	68449		68458				68467	
0.0027				68442	68451		68459				68468	
0.0033				68443	68452		68461				68469	
0.0039				68444	68453		68462				68471	
0.0047		5.0 x 11.0 x 12.5	0.82	68159	68164	1000	68168	1000			68191	1100
0.0056				68161	68165		68169				68192	
0.0068		6.0 x 12.0 x 12.5	1.1	68162	68166	750	68171	750			68193	900
0.0082				68163	68167		68172				68194	
PITCH = 10.0 mm ± 0.4 mm; d_t = 0.60 mm ± 0.06 mm; C-TOL. = ± 5 % (U_{RDC} = 1000 V)												
0.0010		4.0 x 10.0 x 12.5	0.6	68481	68489	1000	68498	1250			68507	1400
0.0012				68482	68491		68499				68508	
0.0015				68483	68492		68501				68509	
0.0018				68484	68493		68502				68511	
0.0022				68485	68494		68503				68512	
0.0027				68486	68495		68504				68513	
0.0033				68487	68496		68505				68514	
0.0039				68488	68497		68506				68515	
0.0047		5.0 x 11.0 x 12.5	0.82	68245	68249	1000	68254	1000			68357	1100
0.0056				68246	68251		68255				68358	
0.0068		6.0 x 12.0 x 12.5	1.1	68247	68252	750	68256	750			68359	900
0.0082				68248	68253		68257				68361	

Notes

- SPQ = Standard Packing Quantity

(1) H = in-tape height; P₀ = sprocket hole distance; for detailed specifications refer to packaging information: www.vishay.com/doc?28139

(2) Reel diameter = 365 mm is available on request

(3) Weight for short lead product only



ELECTRICAL DATA AND ORDERING INFORMATION - PITCH 15 mm												
U _{RAC} (V)	CAP. (μF)	DIMENSIONS w x h x l (mm)	MASS (g) ⁽³⁾	CATALOG NUMBER BFC2 338 6X XXX AND PACKAGING								
				LOOSE IN BOX				AMMOPACK		REEL Ø = 500 mm ⁽¹⁾⁽²⁾		
				SHORT LEADS		LONG LEADS						
				l _t = 3.5 mm ± 0.3 mm	l _t = 5.0 mm ± 1.0 mm	SPQ	l _t = 25.0 mm ± 2.0 mm	SPQ	H = 18.5 mm; P ₀ = 12.7 mm	SPQ	H = 18.5 mm; P ₀ = 12.7 mm	SPQ
PITCH = 15.0 mm ± 0.4 mm; d_t = 0.60 mm ± 0.06 mm; C-TOL. = ± 20 % (U_{RDC} = 1000 V)												
0.0068		5.0 x 11.0 x 17.5	1.0	60682	62682	1000	64682	1000	-	-	68146	1100
0.0082				60822	62822		64822				68147	
0.010				60103	62103		64103				68148	
0.012				60123	62123		64123				68149	
0.015		6.0 x 12.0 x 17.5	1.4	60153	62153	1000	64153	1000	-	-	68151	900
0.018				60183	62183		64183				68152	
PITCH = 15.0 mm ± 0.4 mm; d_t = 0.80 mm ± 0.08 mm; C-TOL. = ± 20 % (U_{RDC} = 1000 V)												
0.022		7.0 x 13.5 x 17.5	1.8	60223	62223	750	64223	500	-	-	68153	800
0.027				60273	62273		64273				68154	
0.033		8.5 x 15.0 x 17.5	2.4	60333	62333	750	64333	500	-	-	68155	650
0.039				60393	62393		64393				68156	
0.047		10.0 x 16.5 x 17.5	3.0	60473	62473	500	64473	450	-	-	68157	600
0.056				60563	62563		64563				68158	
PITCH = 15.0 mm ± 0.4 mm; d_t = 0.60 mm ± 0.06 mm; C-TOL. = ± 10 % (U_{RDC} = 1000 V)												
0.0068		5.0 x 11.0 x 17.5	1.0	61682	63682	1000	65682	1000	-	-	68202	1100
0.0082				61822	63822		65822				68203	
0.010				61103	63103		65103				68204	
0.012				61123	63123		65123				68205	
0.015		6.0 x 12.0 x 17.5	1.4	61153	63153	1000	65153	1000	-	-	68206	900
0.018				61183	63183		65183				68207	
PITCH = 15.0 mm ± 0.4 mm; d_t = 0.80 mm ± 0.08 mm; C-TOL. = ± 10 % (U_{RDC} = 1000 V)												
0.022		7.0 x 13.5 x 17.5	1.8	61223	63223	750	65223	500	-	-	68208	800
0.027				61273	63273		65273				68209	
0.033		8.5 x 15.0 x 17.5	2.4	61333	63333	750	65333	500	-	-	68211	650
0.039				61393	63393		65393				68212	
0.047		10.0 x 16.5 x 17.5	3	61473	63473	500	65473	450	-	-	68213	600
0.047				61473	63473		65473				68213	
PITCH = 15.0 mm ± 0.4 mm; d_t = 0.60 mm ± 0.06 mm; C-TOL. = ± 5 % (U_{RDC} = 1000 V)												
0.0068		5.0 x 11.0 x 17.5	1.0	68258	68284	1000	68309	1000	-	-	68381	1100
0.0082				68259	68285		68311				68382	
0.010				68261	68286		68312				68383	
0.012				68262	68287		68313				68384	
0.015		6.0 x 12.0 x 17.5	1.4	68263	68288	1000	68314	1000	-	-	68385	900
0.015				68263	68288		68314				68385	
PITCH = 15.0 mm ± 0.4 mm; d_t = 0.80 mm ± 0.08 mm; C-TOL. = ± 5 % (U_{RDC} = 1000 V)												
0.018		7.0 x 13.5 x 17.5	1.8	68264	68289	750	68315	500	-	-	68386	800
0.022				68265	68291		68316				68387	
0.027		8.5 x 15.0 x 17.5	2.4	68266	68292	750	68317	500	-	-	68388	650
0.033				68267	68293		68318				68389	
0.039		10.0 x 16.5 x 17.5	3.0	68268	68294	500	68319	450	-	-	68391	600

Notes

- SPQ = Standard Packing Quantity

(1) H = in-tape height; P₀ = sprocket hole distance; for detailed specifications refer to packaging information: www.vishay.com/doc?28139

(2) Reel diameter = 365 mm is available on request

(3) Weight for short lead product only



ELECTRICAL DATA AND ORDERING INFORMATION - PITCH 22.5 mm																	
U _{RAC} (V)	CAP. (μF)	DIMENSIONS w x h x l (mm)	MASS (g) ⁽³⁾	CATALOG NUMBER BFC2 338 6X XXX AND PACKAGING													
				LOOSE IN BOX					AMMOPACK		REEL Ø = 500 mm ⁽¹⁾⁽²⁾						
				SHORT LEADS			LONG LEADS										
				l _t = 3.5 mm ± 0.3 mm	l _t = 5.0 mm ± 1.0 mm	SPQ	l _t = 25.0 mm ± 2.0 mm	SPQ	H = 18.5 mm; P ₀ = 12.7 mm	SPQ	H = 18.5 mm; P ₀ = 12.7 mm	SPQ					
PITCH = 22.5 mm ± 0.4 mm; d_t = 0.80 mm ± 0.08 mm; C-TOL. = ± 20 % (U_{RDC} = 1000 V)																	
300	0.047	7.0 x 16.5 x 26.0	2.9	68123	68125	200	68127	250	-	-	-	-					
	0.056			68124	68126		68128										
	0.068	8.5 x 18.0 x 26.0	3.8	60683	62683	200	64683	250									
	0.082			60823	62823		64823										
	0.10	10.0 x 19.5 x 26.0	6.8	60104	62104	200	64104	200									
	0.12	12.0 x 22.0 x 26.0	7.8	60124	62124	150	64124	200									
				60154	62154		64154										
	PITCH = 22.5 mm ± 0.4 mm; d_t = 0.80 mm ± 0.08 mm; C-TOL. = ± 10 % (U_{RDC} = 1000 V)																
	0.047	7.0 x 16.5 x 26.0	2.9	68173	68175	200	68177	250					-	-	-	-	
	0.056	8.5 x 18.0 x 26.0	3.8	68174	68176		68178										
	0.068			61683	63683	65683											
	0.082	10.0 x 19.5 x 26.0	6.8	61823	63823	200	65823	200									
0.10	61104			63104	65104												
0.12	12.0 x 22.0 x 26.0	7.8	61124	63124	150	65124	200										
			61154	63154		65154											
PITCH = 22.5 mm ± 0.4 mm; d_t = 0.80 mm ± 0.08 mm; C-TOL. = ± 5 % (U_{RDC} = 1000 V)																	
0.047	7.0 x 16.5 x 26.0	2.9	68269	68295	200	68321	250	-	-	-	-						
0.056	8.5 x 18.0 x 26.0	3.8	68271	68296		68322											
0.068			68272	68297	68323												
0.082	10.0 x 19.5 x 26.0	6.8	68273	68298	150	68324	200										
0.10	12.0 x 22.0 x 26.0	7.8	68274	68299		68325											
			68275	68301	68326												

Notes

- SPQ = Standard Packing Quantity

(1) H = in-tape height; P₀ = sprocket hole distance; for detailed specifications refer to packaging information: www.vishay.com/doc?28139

(2) Reel diameter = 365 mm is available on request

(3) Weight for short lead product only

ELECTRICAL DATA AND ORDERING INFORMATION - PITCH 27.5 mm												
U_{RAC} (V)	CAP. (μ F)	DIMENSIONS w x h x l (mm)	MASS (g) ⁽³⁾	CATALOG NUMBER BFC2 338 6X XXX AND PACKAGING								
				LOOSE IN BOX					AMMOPACK		REEL $\varnothing = 500$ mm ⁽¹⁾⁽²⁾	
				SHORT LEADS			LONG LEADS					
				$l_t = 3.5$ mm ± 0.3 mm	$l_t = 5.0$ mm ± 1.0 mm	SPQ	$l_t = 25.0$ mm ± 2.0 mm	SPQ	H = 18.5 mm; P ₀ = 12.7 mm	SPQ	H = 18.5 mm; P ₀ = 12.7 mm	SPQ
PITCH = 27.5 mm \pm 0.4 mm; $d_t = 0.80$ mm \pm 0.08 mm; C-TOL. = \pm 20 % ($U_{RDC} = 1000$ V)												
0.18	13.0 x 23.0 x 31.0	9.2	60184	62184	100	64184	125	-	-	-		
0.22			60224	62224		64224						
0.27	15.0 x 25.0 x 31.0	12.3	60274	62274	100	64274	125					
0.33	18.0 x 28.0 x 31.0	16.1	60334	62334	100	64334	100					
0.39			60394	62394		64394						
0.47	21.0 x 31.0 x 31.0	20.3	60474	62474	50	64474	75					
PITCH = 27.5 mm \pm 0.4 mm; $d_t = 0.80$ mm \pm 0.08 mm; C-TOL. = \pm 10 % ($U_{RDC} = 1000$ V)												
0.18	13.0 x 23.0 x 31.0	9.2	61184	63184	100	65184	125	-	-	-		
0.22	15.0 x 25.0 x 31.0	12.3	61224	63224		65224						
0.27	18.0 x 28.0 x 31.0	16.1	61274	63274	100	65274	100					
0.33			61334	63334		65334						
0.39	21.0 x 31.0 x 31.0	20.3	61394	63394	50	65394	75					
0.47			61474	63474		65474						
PITCH = 27.5 mm \pm 0.4 mm; $d_t = 0.80$ mm \pm 0.08 mm; C-TOL. = \pm 5 % ($U_{RDC} = 1000$ V)												
0.15	13.0 x 23.0 x 31.0	9.2	68276	68302	100	68327	125	-	-	-		
0.18			68277	68303		68328						
0.22	15.0 x 25.0 x 31.5	12.3	68278	68304	100	68329	100					
0.27	18.0 x 28.0 x 31.5	16.1	68279	68305		68331						
0.33			68281	68306	68332							
0.39	21.0 x 31.0 x 31.0	20.3	68282	68307	50	68333	75					



Notes

- SPQ = Standard Packing Quantity

(1) H = in-tape height; P₀ = sprocket hole distance; for detailed specifications refer to packaging information: www.vishay.com/doc?28139

(2) Reel diameter = 365 mm is available on request

(3) Weight for short lead product only

APPROVALS				
SAFETY APPROVALS Y2	VOLTAGE	VALUE	FILE NUMBERS	LINK
EN 60384-14 (ENEC) (= IEC 60384-14 ed-4 (2013))	300 V _{AC}	1 nF to 470 nF	ENEC16/FI/19/10000	www.vishay.com/doc?28212
UL 60384-14 2 nd edition	300 V _{AC}	1 nF to 470 nF	E354331	www.vishay.com/doc?28189
CSA E60384-1:14 3 rd edition	300 V _{AC}	1 nF to 470 nF	E354331	
CB-test certificate	300 V _{AC}	1 nF to 470 nF	FI-39810	www.vishay.com/doc?28213
The ENEC-approval together with the CB-certificate replace all national marks of the following countries (they have already signed the ENEC-agreement): Austria; Belgium; Czech. Republic; Denmark; Finland; France; Germany; Greece; Hungary; Ireland; Italy; Luxembourg; Netherlands; Norway; Portugal; Slovenian; Spain; Switzerland and United Kingdom.				
  				

MOUNTING

Normal Use

The capacitors are designed for mounting on printed-circuit boards. The capacitors packed in bandoleers are designed for mounting in printed circuit boards by means of automatic insertion machines.

For detailed tape specifications refer to packaging information: www.vishay.com/doc?28139

Specific Method of Mounting to Withstand Vibration and Shock

In order to withstand vibration and shock tests, it must be ensured that the stand-off pips are in good contact with the printed-circuit board:

- For pitches ≤ 15 mm capacitors shall be mechanically fixed by the leads
- For larger pitches the capacitors shall be mounted in the same way and the body clamped

Space Requirements on Printed-Circuit Board

The maximum space for length ($l_{max.}$), width ($w_{max.}$), and height ($h_{max.}$) of film capacitors to take in account on the printed-circuit board is shown in the drawings:

- For products with pitch ≤ 15 mm, $\Delta w = \Delta l = 0.3$ mm; $\Delta h = 0.1$ mm
- For products with 15 mm $<$ pitch, ≤ 27.5 mm, $\Delta w = \Delta l = 0.5$ mm; $\Delta h = 0.1$ mm

Eccentricity defined as in drawing. The maximum eccentricity is smaller than or equal to the lead diameter of the product concerned.

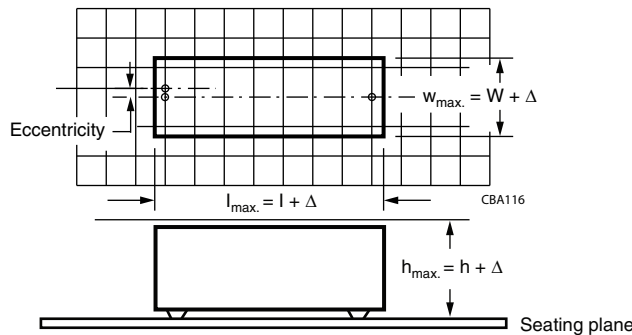

SOLDERING CONDITIONS

For general soldering conditions and wave soldering profile, we refer to the application note:

“Soldering Guidelines for Film Capacitors”: www.vishay.com/doc?28171

Storage Temperature

$T_{stg} = -25$ °C to $+35$ °C with RH maximum 75 % without condensation

Ratings and Characteristics Reference Conditions

Unless otherwise specified, all electrical values apply to an ambient temperature of 23 °C ± 1 °C, an atmospheric pressure of 86 kPa to 106 kPa and a relative humidity of 50 % ± 2 %.

For reference testing, a conditioning period shall be applied over 96 h ± 4 h by heating the products in a circulating air oven at the rated temperature and a relative humidity not exceeding 20 %.



CHARACTERISTICS

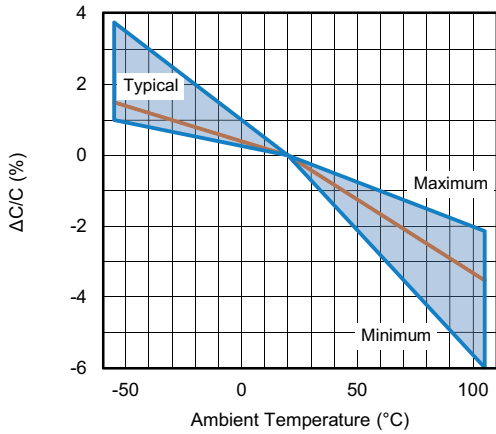

Capacitance as a function of ambient temperature (typical curve)

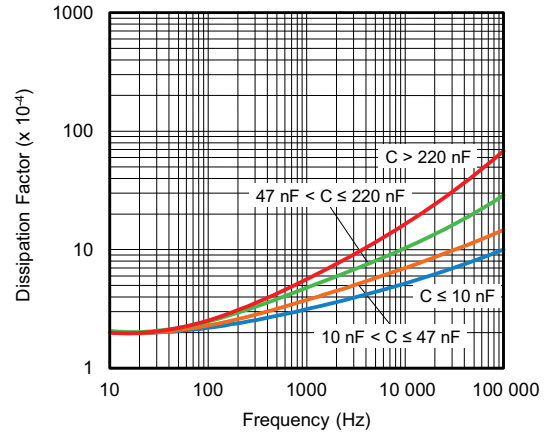

Tangent of loss angle as a function of frequency (typical curve)



Impedance as a function of frequency (typical curve)

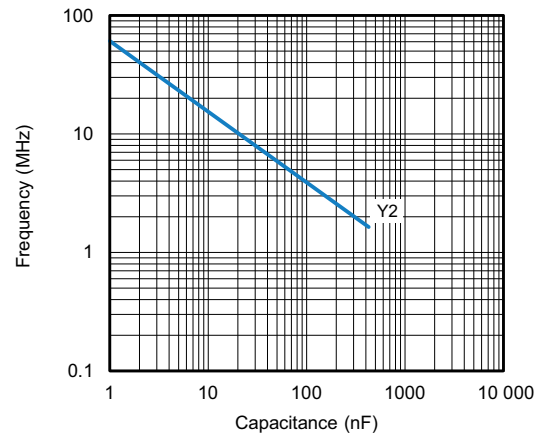

Resonant frequency as a function of capacitance (typical curve)



Max. RMS voltage as a function of frequency

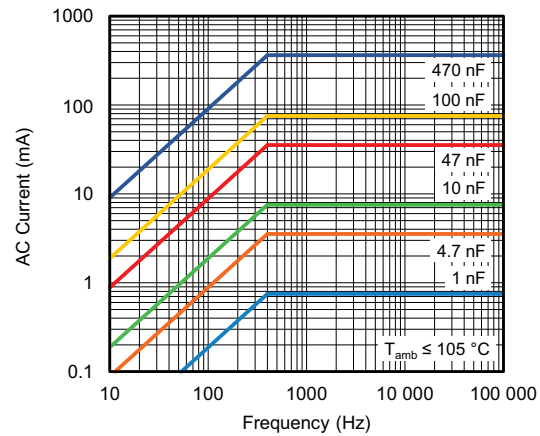

Max. RMS current as a function of frequency

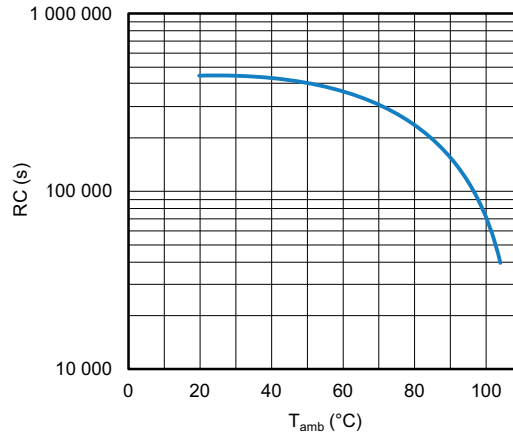

Insulation resistance as a function of ambient temperature

APPLICATION NOTES

- For Y2 electromagnetic interference suppression in **standard line bypass applications** (between line and ground) (50 Hz / 60 Hz) with a maximum mains voltage of 300 V_{AC}.
- For series impedance applications we refer to the application note: www.vishay.com/doc?28153
- For capacitors connected in parallel, normally the proof voltage and possibly the rated voltage must be reduced. For information depending of the capacitance value and the number of parallel connections contact rfi@vishay.com
- These capacitors are not intended for continuous pulse applications. For these situations, capacitors of the AC and pulse program must be used.
- The maximum ambient temperature must not exceed 105 °C.
- Rated voltage pulse slope:
if the pulse voltage is lower than the rated voltage, the values of the specific reference data can be multiplied by 420 V_{DC} and divided by the applied voltage.

INSPECTION REQUIREMENTS

General Notes

Sub-clause numbers of tests and performance requirements refer to the “Sectional Specification, Publication IEC 60384-14 ed-4 (2013) and Specific Reference Data.”

GROUP C INSPECTION REQUIREMENTS		
SUB-CLAUSE NUMBER AND TEST	CONDITIONS	PERFORMANCE REQUIREMENTS
SUB-GROUP C1A PART OF SAMPLE OF SUB-GROUP C1		
4.1 Dimensions (detail)		As specified in chapters “General Data” of this specification
Initial measurements	Capacitance Tangent of loss angle: at 10 kHz	
4.3 Robustness of terminations	Tensile: load 10 N; 10 s Bending: load 5 N; 4 x 90°	No visible damage
4.4 Resistance to soldering heat	No pre-drying Method: 1A Solder bath: 280 °C ± 5 °C Duration: 10 s	



GROUP C INSPECTION REQUIREMENTS		
SUB-CLAUSE NUMBER AND TEST	CONDITIONS	PERFORMANCE REQUIREMENTS
SUB-GROUP C1A PART OF SAMPLE OF SUB-GROUP C1		
4.19 Component solvent resistance	Isopropylalcohol at room temperature Method: 2 Immersion time: 5 min ± 0.5 min Recovery time: min. 1 h, max. 2 h	
4.4.2 Final measurements	Visual examination	No visible damage Legible marking
	Capacitance	$ \Delta C/C \leq 5\%$ of the value measured initially
	Tangent of loss angle	Increase of $\tan \delta \leq 0.008$ Compared to values measured initially
	Insulation resistance	As specified in section "Insulation Resistance" of this specification
SUB-GROUP C1B PART OF SAMPLE OF SUB-GROUP C1		
Initial measurements	Capacitance Tangent of loss angle: at 10 kHz	
4.20 Solvent resistance of the marking:	Isopropylalcohol at room temperature Method: 1 Rubbing material: cotton wool Immersion time: 5 min ± 0.5 min	No visible damage Legible marking
4.6 Rapid change of temperature	$\theta A = -55\text{ }^\circ\text{C}$ $\theta B = +105\text{ }^\circ\text{C}$ 5 cycles Duration $t = 30\text{ min}$	
4.6.1 Inspection	Visual examination	No visible damage
4.7 Vibration	Mounting: see section "Mounting" of this specification Procedure B4: Frequency range: 10 Hz to 55 Hz Amplitude: 0.75 mm or Acceleration 98 m/s ² (whichever is less severe) Total duration 6 h	
4.7.2 Final inspection	Visual examination	No visible damage
4.9 Shock	Mounting: see section "Mounting" for more information Pulse shape: half sine Acceleration: 490 m/s ² Duration of pulse: 11 ms	
4.9.2 Final measurements	Visual examination	No visible damage
	Capacitance	$ \Delta C/C \leq 5\%$ of the value measured initially
	Tangent of loss angle	Increase of $\tan \delta \leq 0.008$ Compared to values measured initially
	Insulation resistance	As specified in section "Insulation Resistance" of this specification



GROUP C INSPECTION REQUIREMENTS		
SUB-CLAUSE NUMBER AND TEST	CONDITIONS	PERFORMANCE REQUIREMENTS
SUB-GROUP C1 COMBINED SAMPLE OF SPECIMENS OF SUB-GROUPS C1A AND C1B		
4.11 Climatic sequence		
4.11.1 Initial measurements	Capacitance measured in 4.4.2 and 4.9.2 Tangent of loss angle: measured initially in C1A and C1B	
4.11.2 Dry heat	Temperature: 105 °C Duration: 16 h	
4.11.3 Damp heat cyclic Test Db First cycle		
4.11.4 Cold	Temperature: -55 °C Duration: 2 h	
4.11.5 Damp heat cyclic Test Db remaining cycles		
4.11.6 Final measurements	Visual examination Capacitance Tangent of loss angle Voltage proof 2250 V _{DC} ; 1 min between terminations Insulation resistance	No visible damage Legible marking $ \Delta C/C \leq 5\%$ of the value measured in 4.11.1. Increase of $\tan \delta \leq 0.008$ Compared to values measured in 4.11.1 No permanent breakdown or flash-over $\geq 50\%$ of values specified in section "Insulation Resistance" of this specification
SUB-GROUP C2		
4.12 Damp heat steady state	56 days, 40 °C, 90 % to 95 % RH, no load Capacitance	
4.12.1 Initial measurements	Tangent of loss angle at 1 kHz	
4.12.3 Final measurements	Visual examination Capacitance Tangent of loss angle Voltage proof 2250 V _{DC} ; 1 min between terminations Insulation resistance	No visible damage Legible marking $ \Delta C/C \leq 5\%$ of the value measured in 4.12.1. Increase of $\tan \delta \leq 0.007$ Compared to values measured in 4.12.1. No permanent breakdown or flash-over $\geq 50\%$ of values specified in section "Insulation Resistance" of this specification

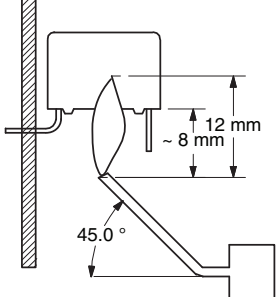

GROUP C INSPECTION REQUIREMENTS		
SUB-CLAUSE NUMBER AND TEST	CONDITIONS	PERFORMANCE REQUIREMENTS
SUB-GROUP C3		
4.13.1 Initial measurements	Capacitance Tangent of loss angle: at 10 kHz	
4.13 Impulse voltage	3 successive impulses, full wave, peak voltage: X1: 5 kV Max. 24 pulses	No selfhealing breakdowns or flash-over
4.14 Endurance	Duration: 1000 h 1.7 x U _{RAC} at 105 °C Once in every hour the voltage is increased to 1000 V _{RMS} for 0.1 s via resistor of 47 Ω ± 5 %	
4.14.7 Final measurements	Visual examination	No visible damage Legible marking
	Capacitance	ΔC/C ≤ 10 % compared to values measured in 4.13.1.
	Tangent of loss angle	Increase of tan δ ≤ 0.008 Compared to values measured in 4.13.1.
	Voltage proof 2250 V _{DC} ; 1 min between terminations 2100 V _{AC} ; 1 min between terminations and case	No permanent breakdown or flash-over
	Insulation resistance	≥ 50 % of values specified in section "Insulation Resistance" of this specification
SUB-GROUP C4		
4.15 Charge and discharge	10 000 cycles charged to 420 V _{DC} Discharge resistance: $R = \frac{420 V_{DC}}{1.5 \times C (dU/dt)}$	
4.15.1 Initial measurements	Capacitance Tangent of loss angle: at 10 kHz	
4.15.3 Final measurements	Capacitance	ΔC/C ≤ 10 % compared to values measured in 4.15.1.
	Tangent of loss angle	Increase of tan δ ≤ 0.008 Compared to values measured in 4.15.1.
	Insulation resistance	≥ 50 % of values specified in section "Insulation Resistance" of this specification

GROUP C INSPECTION REQUIREMENTS		
SUB-CLAUSE NUMBER AND TEST	CONDITIONS	PERFORMANCE REQUIREMENTS
SUB-GROUP C5		
4.16 Radio frequency characteristic	Resonance frequency	≥ 0.9 times the value as specified in section "Resonant Frequency" of this specification
SUB-GROUP C6		
4.17 Passive flammability Class B	Bore of gas jet: $\varnothing 0.5$ mm Fuel: Butane Test duration for actual volume V in mm^3 : $V \leq 250$: 10 s $250 < V \leq 500$: 20 s $500 < V \leq 1750$: 30 s $V > 1750$: 60 s One flame application 	After removing test flame from capacitor, the capacitor must not continue to burn for more than 10 s. No burning particle must drop from the sample.
SUB-GROUP C7		
4.18 Active flammability	20 cycles of 5 kV discharges on the test capacitor connected to U_{RAC} .	The cheese cloth around the capacitors shall not burn with a flame. No electrical measurements are required.



Disclaimer

ALL PRODUCT, PRODUCT SPECIFICATIONS AND DATA ARE SUBJECT TO CHANGE WITHOUT NOTICE TO IMPROVE RELIABILITY, FUNCTION OR DESIGN OR OTHERWISE.

Vishay Intertechnology, Inc., its affiliates, agents, and employees, and all persons acting on its or their behalf (collectively, "Vishay"), disclaim any and all liability for any errors, inaccuracies or incompleteness contained in any datasheet or in any other disclosure relating to any product.

Vishay makes no warranty, representation or guarantee regarding the suitability of the products for any particular purpose or the continuing production of any product. To the maximum extent permitted by applicable law, Vishay disclaims (i) any and all liability arising out of the application or use of any product, (ii) any and all liability, including without limitation special, consequential or incidental damages, and (iii) any and all implied warranties, including warranties of fitness for particular purpose, non-infringement and merchantability.

Statements regarding the suitability of products for certain types of applications are based on Vishay's knowledge of typical requirements that are often placed on Vishay products in generic applications. Such statements are not binding statements about the suitability of products for a particular application. It is the customer's responsibility to validate that a particular product with the properties described in the product specification is suitable for use in a particular application. Parameters provided in datasheets and / or specifications may vary in different applications and performance may vary over time. All operating parameters, including typical parameters, must be validated for each customer application by the customer's technical experts. Product specifications do not expand or otherwise modify Vishay's terms and conditions of purchase, including but not limited to the warranty expressed therein.

Except as expressly indicated in writing, Vishay products are not designed for use in medical, life-saving, or life-sustaining applications or for any other application in which the failure of the Vishay product could result in personal injury or death. Customers using or selling Vishay products not expressly indicated for use in such applications do so at their own risk. Please contact authorized Vishay personnel to obtain written terms and conditions regarding products designed for such applications.

No license, express or implied, by estoppel or otherwise, to any intellectual property rights is granted by this document or by any conduct of Vishay. Product names and markings noted herein may be trademarks of their respective owners.

单击下面可查看定价，库存，交付和生命周期等信息

[>>Vishay\(威世\)](#)

[>>点击查看相关商品](#)