

## Surface-Mount Ultrafast Plastic Rectifier

**SMC (DO-214AB)**

Cathode Anode

### FEATURES

- Glass passivated pellet chip junction
- Ideal for automated placement
- Ultrafast recovery times for high efficiency
- Low forward voltage, low power loss
- High forward surge capability
- Meets MSL level 1, per J-STD-020, LF maximum peak of 260 °C
- AEC-Q101 qualified
- Material categorization: for definitions of compliance please see [www.vishay.com/doc?99912](http://www.vishay.com/doc?99912)

**RoHS**  
COMPLIANT

### LINKS TO ADDITIONAL RESOURCES

[3D Models](#)

### PRIMARY CHARACTERISTICS

$I_{F(AV)}$	3.0 A
$V_{RRM}$	100 V, 150 V, 200 V
$t_{rr}$	25 ns
$V_F$ at $I_F$	0.90 V
$T_J$ max.	175 °C
Package	SMC (DO-214AB)
Circuit configuration	Single

### TYPICAL APPLICATIONS

For use in high frequency rectification and freewheeling application in switching mode converter and inverter for both, industrial and automotive.

### MECHANICAL DATA

**Case:** SMC (DO-214AB)

Molding compound meets UL 94 V-0 flammability rating Base P/N-E3 - RoHS-compliant, industrial grade Base P/NHE3\_X - RoHS-compliant and AEC-Q101 qualified (“\_X” denotes revision code e.g. A, B, .....)

**Terminals:** matte tin plated leads, solderable per J-STD-002 and JESD 22-B102

E3 suffix meets JESD 201 class 2 whisker test, HE3 suffix meets JESD 201 class 2 whisker test

**Polarity:** color band denotes cathode end

### MAXIMUM RATINGS ( $T_A = 25\text{ °C}$ unless otherwise noted)

PARAMETER	SYMBOL	ESH3B	ESH3C	ESH3D	UNIT
Device marking code		EHB	EHC	EHD	
Maximum repetitive peak reverse voltage	$V_{RRM}$	100	150	200	V
Maximum RMS voltage	$V_{RMS}$	70	105	140	
Maximum DC blocking voltage	$V_{DC}$	100	150	200	
Maximum average forward rectified current (fig. 1)	$I_{F(AV)}$	3.0			A
Peak forward surge current 8.3 ms single half sine-wave superimposed on rated load	$I_{FSM}$	125			
Operating junction and storage temperature range	$T_J, T_{STG}$	-55 to +175			°C



<b>ELECTRICAL CHARACTERISTICS</b> ( $T_A = 25\text{ }^\circ\text{C}$ unless otherwise noted)					
PARAMETER	TEST CONDITIONS		SYMBOL	VALUE	UNIT
Maximum instantaneous forward voltage	$I_F = 3\text{ A}$		$V_F^{(1)}$	0.90	V
Maximum DC reverse current at rated DC blocking voltage		$T_A = 25\text{ }^\circ\text{C}$	$I_R$	5.0	$\mu\text{A}$
		$T_A = 125\text{ }^\circ\text{C}$		150	
Maximum reverse recovery time	$I_F = 0.5\text{ A}, I_R = 1\text{ A}, I_{rr} = 0.25\text{ A}$		$t_{rr}$	25	ns
Typical reverse recovery time	$I_F = 3\text{ A}, V_R = 30\text{ V},$ $di/dt = 50\text{ A}/\mu\text{s}, I_{rr} = 10\% I_{RM}$	$T_J = 25\text{ }^\circ\text{C}$	$t_{rr}$	40	
		$T_J = 100\text{ }^\circ\text{C}$		55	
Typical stored charge	$I_F = 3\text{ A}, V_R = 30\text{ V},$ $di/dt = 50\text{ A}/\mu\text{s}, I_{rr} = 10\% I_{RM}$	$T_J = 25\text{ }^\circ\text{C}$	$Q_{rr}$	25	nC
		$T_J = 100\text{ }^\circ\text{C}$		60	
Typical junction capacitance	4.0 V, 1 MHz		$C_J$	70	pF

**Note**(1) Pulse test: 300  $\mu\text{s}$  pulse width, 1 % duty cycle

<b>THERMAL CHARACTERISTICS</b> ( $T_A = 25\text{ }^\circ\text{C}$ unless otherwise noted)					
PARAMETER	SYMBOL	ESH3B	ESH3C	ESH3D	UNIT
Typical thermal resistance	$R_{\theta JA}^{(1)}$	50			$^\circ\text{C}/\text{W}$
	$R_{\theta JL}^{(1)}$	15			

**Note**

(1) Units mounted on PCB with 12.0 mm x 12.0 mm land areas

<b>ORDERING INFORMATION</b> (Example)				
PREFERRED P/N	UNIT WEIGHT (g)	PREFERRED PACKAGE CODE	BASE QUANTITY	DELIVERY MODE
ESH3D-E3/57T	0.211	57T	850	7" diameter plastic tape and reel
ESH3D-E3/9AT	0.211	9AT	3500	13" diameter plastic tape and reel
ESH3DHE3_A/H <sup>(1)</sup>	0.211	H	850	7" diameter plastic tape and reel
ESH3DHE3_A/I <sup>(1)</sup>	0.211	I	3500	13" diameter plastic tape and reel

**Note**

(1) AEC-Q101 qualified

**RATINGS AND CHARACTERISTICS CURVES** ( $T_A = 25\text{ }^\circ\text{C}$  unless otherwise noted)

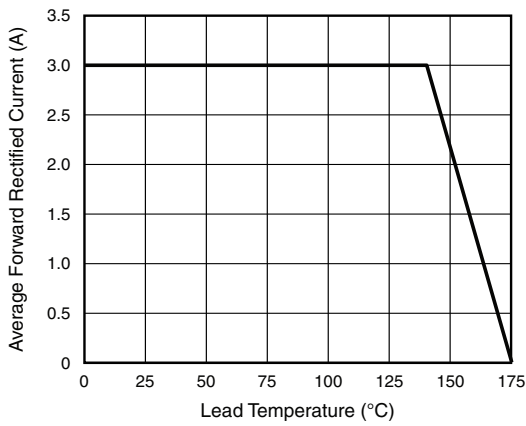

Fig. 1 - Maximum Forward Current Derating Curve

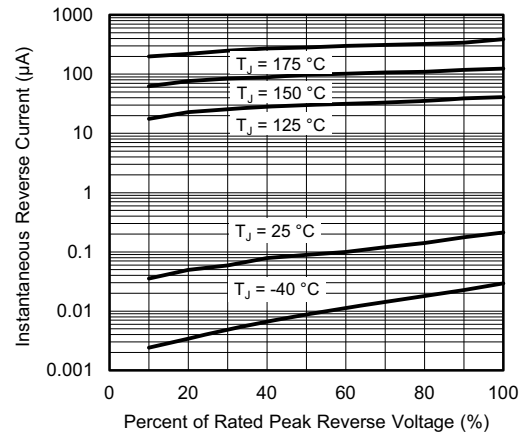

Fig. 4 - Typical Reverse Leakage Characteristics

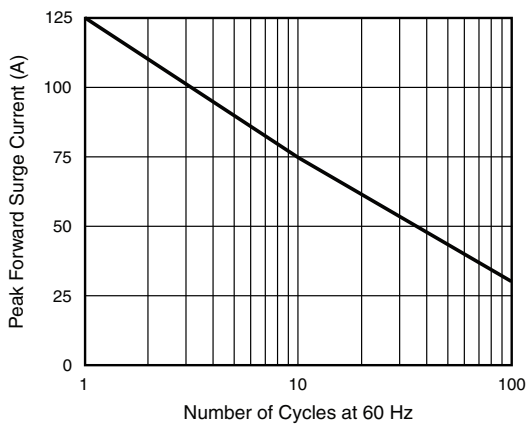

Fig. 2 - Maximum Non-Repetitive Peak Forward Surge Current

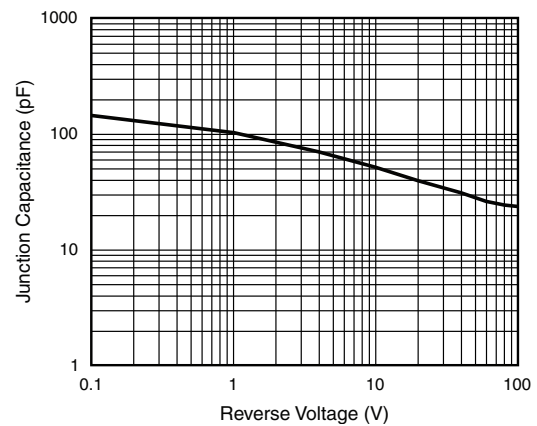

Fig. 5 - Typical Junction Capacitance

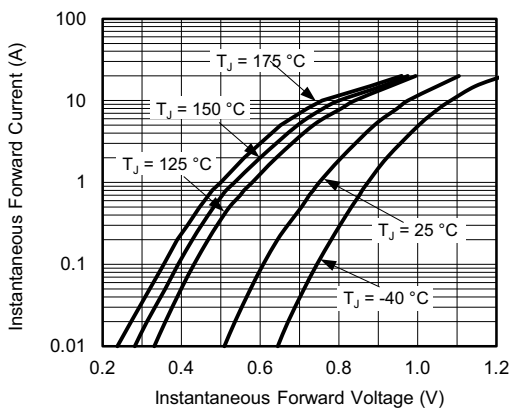

Fig. 3 - Typical Instantaneous Forward Characteristics

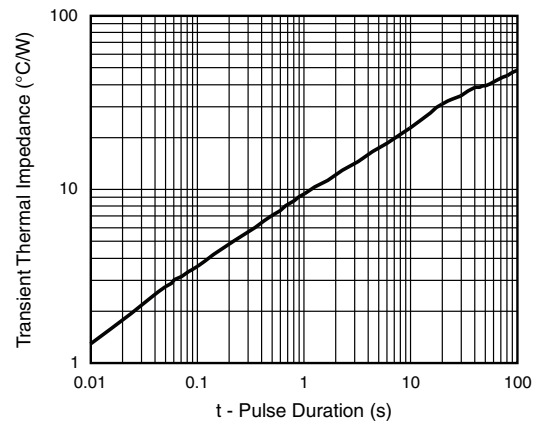
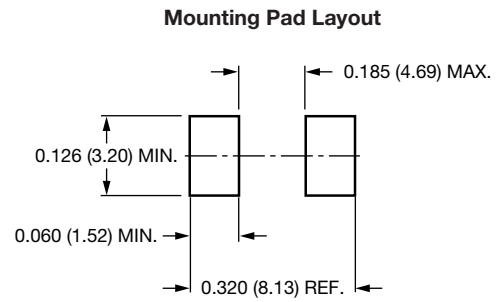
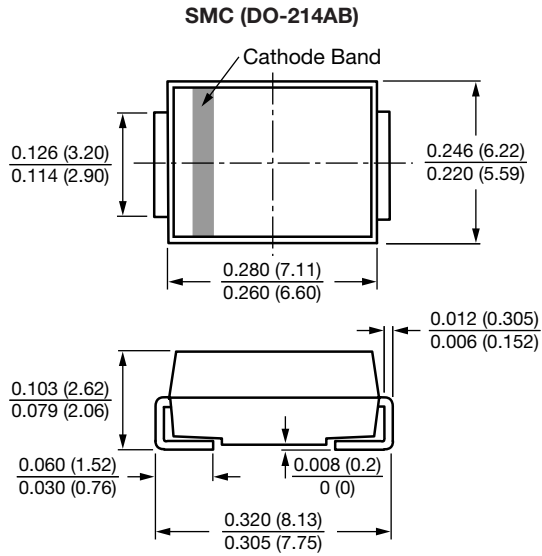

Fig. 6 - Typical Transient Thermal Impedance



### PACKAGE OUTLINE DIMENSIONS in inches (millimeters)





## Disclaimer

ALL PRODUCT, PRODUCT SPECIFICATIONS AND DATA ARE SUBJECT TO CHANGE WITHOUT NOTICE TO IMPROVE RELIABILITY, FUNCTION OR DESIGN OR OTHERWISE.

Vishay Intertechnology, Inc., its affiliates, agents, and employees, and all persons acting on its or their behalf (collectively, "Vishay"), disclaim any and all liability for any errors, inaccuracies or incompleteness contained in any datasheet or in any other disclosure relating to any product.

Vishay makes no warranty, representation or guarantee regarding the suitability of the products for any particular purpose or the continuing production of any product. To the maximum extent permitted by applicable law, Vishay disclaims (i) any and all liability arising out of the application or use of any product, (ii) any and all liability, including without limitation special, consequential or incidental damages, and (iii) any and all implied warranties, including warranties of fitness for particular purpose, non-infringement and merchantability.

Statements regarding the suitability of products for certain types of applications are based on Vishay's knowledge of typical requirements that are often placed on Vishay products in generic applications. Such statements are not binding statements about the suitability of products for a particular application. It is the customer's responsibility to validate that a particular product with the properties described in the product specification is suitable for use in a particular application. Parameters provided in datasheets and / or specifications may vary in different applications and performance may vary over time. All operating parameters, including typical parameters, must be validated for each customer application by the customer's technical experts. Product specifications do not expand or otherwise modify Vishay's terms and conditions of purchase, including but not limited to the warranty expressed therein.

Hyperlinks included in this datasheet may direct users to third-party websites. These links are provided as a convenience and for informational purposes only. Inclusion of these hyperlinks does not constitute an endorsement or an approval by Vishay of any of the products, services or opinions of the corporation, organization or individual associated with the third-party website. Vishay disclaims any and all liability and bears no responsibility for the accuracy, legality or content of the third-party website or for that of subsequent links.

Except as expressly indicated in writing, Vishay products are not designed for use in medical, life-saving, or life-sustaining applications or for any other application in which the failure of the Vishay product could result in personal injury or death. Customers using or selling Vishay products not expressly indicated for use in such applications do so at their own risk. Please contact authorized Vishay personnel to obtain written terms and conditions regarding products designed for such applications.

No license, express or implied, by estoppel or otherwise, to any intellectual property rights is granted by this document or by any conduct of Vishay. Product names and markings noted herein may be trademarks of their respective owners.

单击下面可查看定价，库存，交付和生命周期等信息

[>>Vishay\(威世\)](#)