

Glass Passivated Junction Fast Switching Rectifier



*Glass-plastic encapsulation technique is covered by Patent No. 3,996,602, brazed-lead assembly by Patent No. 3,930,306

Case Style GP20

PRIMARY CHARACTERISTICS

$I_{F(AV)}$	2.0 A
V_{RRM}	50 V to 600 V
I_{FSM}	80 A
t_{rr}	150 ns, 250 ns
V_F	1.3 V
I_R	5.0 μ A
T_J max.	175 °C

FEATURES

- Superrectifier structure for high reliability condition
- Cavity-free glass-passivated junction
- Fast switching for high efficiency
- Low leakage current, typical I_R less than 0.2 μ A
- High forward surge capability
- Meets environmental standard MIL-S-19500
- Solder dip 260 °C, 40 s
- Component in accordance to RoHS 2002/95/EC and WEEE 2002/96/EC



RoHS
COMPLIANT

TYPICAL APPLICATIONS

For use in fast switching rectification of power supply, inverters, converters and freewheeling diodes for consumer, automotive and telecommunication.

MECHANICAL DATA

Case: GP20, molded epoxy over glass body

Epoxy meets UL 94V-0 flammability rating

Terminals: Matte tin plated leads, solderable per J-STD-002 and JESD22-B102

E3 suffix for consumer grade, meets JESD 201 class 1A whisker test, HE3 suffix for high reliability grade (AEC Q101 qualified), meets JESD 201 class 2 whisker test

Polarity: Color band denotes cathode end

MAXIMUM RATINGS ($T_A = 25$ °C unless otherwise noted)

PARAMETER	SYMBOL	RGP20A	RGP20B	RGP20D	RGP20G	RGP20J	UNIT	
Maximum repetitive peak reverse voltage	V_{RRM}	50	100	200	400	600	V	
Maximum RMS voltage	V_{RMS}	35	70	140	280	420	V	
Maximum DC blocking voltage	V_{DC}	50	100	200	400	600	V	
Maximum average forward rectified current 0.375" (9.5 mm) lead length at $T_A = 55$ °C	$I_{F(AV)}$	2.0						A
Peak forward surge current 8.3 ms single half sine-wave superimposed on rated load	I_{FSM}	80						A
Maximum full load reverse current, full cycle average, 0.375" (9.5 mm) lead length at $T_A = 55$ °C	$I_{R(AV)}$	100						μ A
Operating junction and storage temperature range	T_J, T_{STG}	- 65 to + 175						°C



ELECTRICAL CHARACTERISTICS (T _A = 25 °C unless otherwise noted)									
PARAMETER	TEST CONDITIONS		SYMBOL	RGP20A	RGP20B	RGP20D	RGP20G	RGP20J	UNIT
Maximum instantaneous forward voltage	2.0 A		V _F			1.3			V
Maximum DC reverse current at rated DC blocking voltage		T _A = 25 °C T _A = 125 °C	I _R			5.0 100			μA
Maximum reverse recovery time	I _F = 0.5 A, I _R = 1.0 A, I _{rr} = 0.25 A		t _{rr}		150			250	ns
Typical junction capacitance	4.0 V, 1 MHz		C _J			35			pF

THERMAL CHARACTERISTICS (T _A = 25 °C unless otherwise noted)								
PARAMETER	SYMBOL	RGP20A	RGP20B	RGP20D	RGP20G	RGP20J	UNIT	
Typical thermal resistance ⁽¹⁾	R _{θJA}			22			°C/W	

Note:

(1) Thermal resistance from junction to ambient at 0.375" (9.5 mm) lead length, P.C.B. mounted

ORDERING INFORMATION (Example)				
PREFERRED P/N	UNIT WEIGHT (g)	PREFERRED PACKAGE CODE	BASE QUANTITY	DELIVERY MODE
RGP20J-E3/54	1.013	54	1400	13" diameter paper tape and reel
RGP20J-E3/73	1.013	73	1000	Ammo pack packaging
RGP20JHE3/54 ⁽¹⁾	1.013	54	1400	13" diameter paper tape and reel
RGP20JHE3/73 ⁽¹⁾	1.013	73	1000	Ammo pack packaging

Note:

(1) Automotive grade AEC Q101 qualified

RATINGS AND CHARACTERISTICS CURVES

(T_A = 25 °C unless otherwise noted)

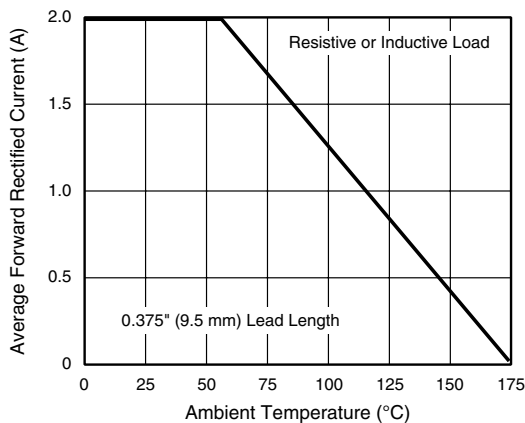

Figure 1. Forward Current Derating Curve

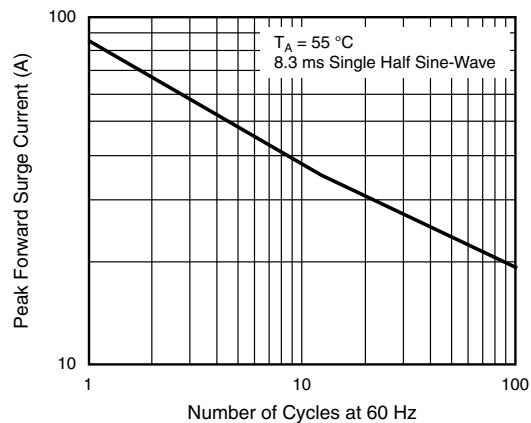

Figure 2. Maximum Non-Repetitive Peak Forward Surge Current

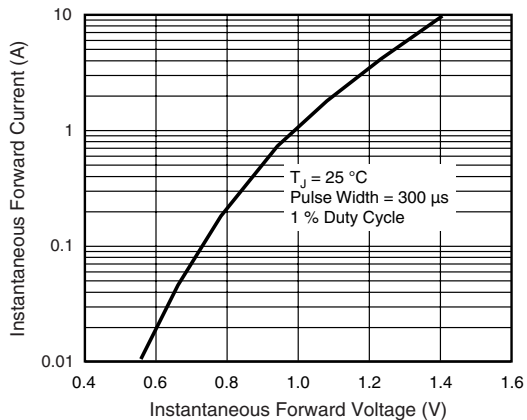

Figure 3. Typical Instantaneous Forward Characteristics

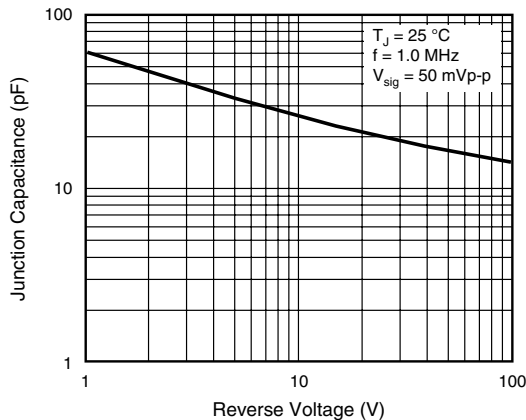

Figure 5. Typical Junction Capacitance

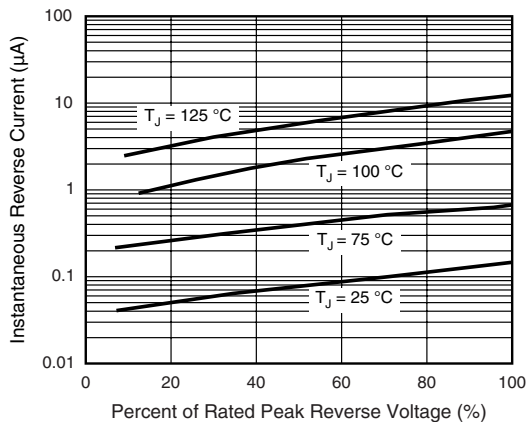

Figure 4. Typical Reverse Characteristics

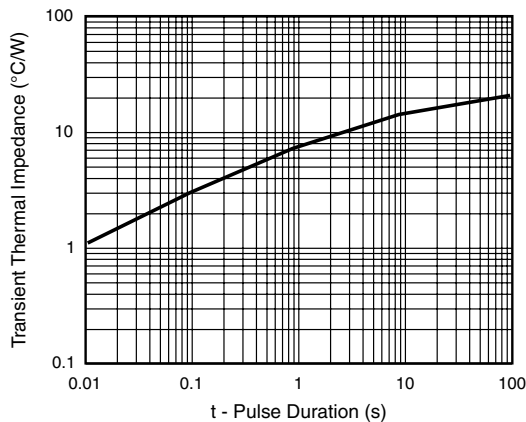
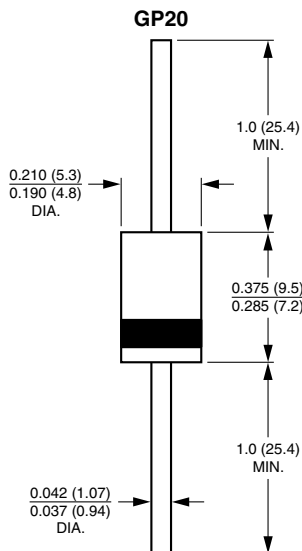

Figure 6. Typical Transient Thermal Impedance

PACKAGE OUTLINE DIMENSIONS in inches (millimeters)





Disclaimer

All product specifications and data are subject to change without notice.

Vishay Intertechnology, Inc., its affiliates, agents, and employees, and all persons acting on its or their behalf (collectively, "Vishay"), disclaim any and all liability for any errors, inaccuracies or incompleteness contained herein or in any other disclosure relating to any product.

Vishay disclaims any and all liability arising out of the use or application of any product described herein or of any information provided herein to the maximum extent permitted by law. The product specifications do not expand or otherwise modify Vishay's terms and conditions of purchase, including but not limited to the warranty expressed therein, which apply to these products.

No license, express or implied, by estoppel or otherwise, to any intellectual property rights is granted by this document or by any conduct of Vishay.

The products shown herein are not designed for use in medical, life-saving, or life-sustaining applications unless otherwise expressly indicated. Customers using or selling Vishay products not expressly indicated for use in such applications do so entirely at their own risk and agree to fully indemnify Vishay for any damages arising or resulting from such use or sale. Please contact authorized Vishay personnel to obtain written terms and conditions regarding products designed for such applications.

Product names and markings noted herein may be trademarks of their respective owners.

单击下面可查看定价，库存，交付和生命周期等信息

[>>Vishay\(威世\)](#)