

Dual 2 A, 1.2 V, Slew Rate Controlled Load Switch

DESCRIPTION

SiP32413, SiP32414 and SiP32416 are slew rate controlled load switches that is designed for 1.1 V to 5.5 V operation.

The devices guarantee low switch on-resistance at 1.2 V input. SiP32413 and SiP32414 feature a controlled soft-on slew rate of typical 150 μ s that limits the inrush current for designs of capacitive load or noise sensitive loads. SiP32416 features a longer slew rate of typical 2.5 ms to keep the peak of the inrush current even lower.

The devices feature a low voltage control logic interface (On/Off interface) that can interface with low voltage digital control without extra level shifting circuit. The SiP32414 and SiP32416 also integrate output discharge switches that enable fast shutdown load discharge. When the switches are off, they provide the reverse blocking to prevent high current flowing into the power source.

All SiP32413, SiP32414 and SiP32416 are available in TDFN8 2 mm x 2 mm package. Each switch in each device can support over 2 A of continuous current.

FEATURES

- **Halogen-free according to IEC 61249-2-21 definition**
- 1.1 V to 5.5 V operation voltage range
- 62 m Ω typical from 2 V to 5 V
- Low R_{ON} down to 1.2 V
- Slew rate controlled turn-on:
 - 150 μ s at 3.6 V for SiP32413, SiP32414
 - 2.5 ms at 3.6 V for SiP32416
- Fast shutdown load discharge for SiP32414 and SiP32416
- Low quiescent current
 - < 1 μ A when disabled
 - 6.7 μ A at V_{IN} = 1.2 V
- Switch off reversed blocking
- **Compliant to RoHS Directive 2002/95/EC**



RoHS
COMPLIANT
HALOGEN
FREE
Available

APPLICATIONS

- Cellular phones
- Portable media players
- Digital camera
- GPS
- Computers
- Portable instruments and healthcare devices

TYPICAL APPLICATION CIRCUIT

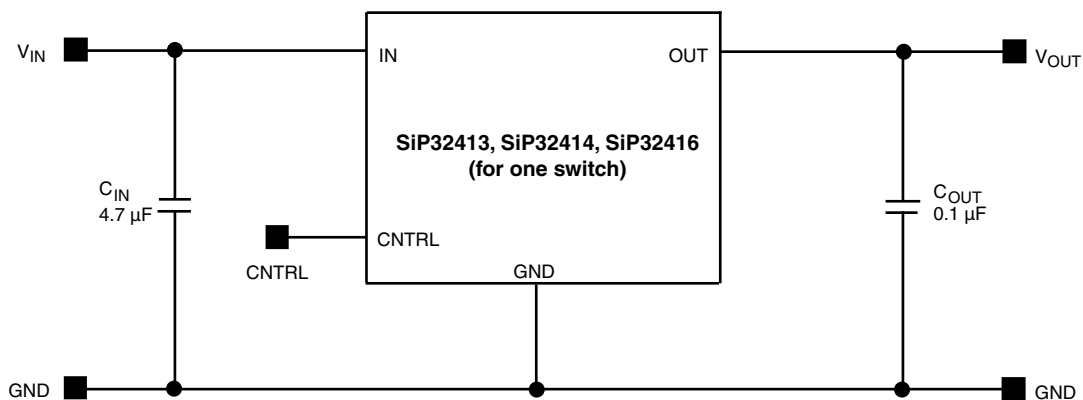

Figure 1 - SiP32413, SiP32414, SiP32416 Typical Application Circuit

| ORDERING INFORMATION | | | |
|----------------------|----------------------|---------|--------------------|
| Temperature Range | Package | Marking | Part Number |
| - 40 °C to 85 °C | TDFN8 2 mm x 2 mm | AA | SiP32413DNP-T1-GE4 |
| | | AB | SiP32414DNP-T1-GE4 |
| | | AG | SiP32416DNP-T1-GE4 |

Note:

GE4 denotes halogen-free and RoHS compliant

| ABSOLUTE MAXIMUM RATINGS | | | |
|--|--|-------------|------|
| Parameter | | Limit | Unit |
| Supply Input Voltage (V_{IN}) | | - 0.3 to 6 | V |
| Enable Input Voltage (V_{EN}) | | - 0.3 to 6 | |
| Output Voltage (V_{OUT}) | | - 0.3 to 6 | |
| Maximum Continuous Switch Current ($I_{max.}$) | | 2.4 | A |
| Maximum Pulsed Current (Pulsed at 1 ms, 10 % Duty Cycle) | | 3 | |
| ESD Rating (HBM) | | 4000 | V |
| Storage Temperature (T_{stg}) | | - 65 to 150 | °C |
| Thermal Resistance (θ_{JA}) ^a | | 95 | °C/W |
| Power Dissipation (P_D) ^{a, b} | | 580 | mW |

Notes:

a. Device mounted with all leads and power pad soldered or welded to PC board, see PCB layout.

b. Derate 10.5 mW/°C above $T_A = 70$ °C, see PCB layout.

Stresses beyond those listed under "Absolute Maximum Ratings" may cause permanent damage to the device. These are stress ratings only, and functional operation of the device at these or any other conditions beyond those indicated in the operational sections of the specifications is not implied. Exposure to absolute maximum rating/conditions for extended periods may affect device reliability.

| RECOMMENDED OPERATING RANGE | | | |
|--|--|-------------|------|
| Parameter | | Limit | Unit |
| Input Voltage Range (V_{IN}) | | 1.1 to 5.5 | V |
| Operating Junction Temperature Range (T_J) | | - 40 to 125 | °C |



| SPECIFICATIONS | | | | | | | |
|---------------------------------------|-----------------------|--|---|-------------------|-------------------|-----------------------|---------------|
| Parameter | Symbol | Test Conditions Unless Specified $V_{IN} = 5\text{ V}$, $T_A = -40\text{ }^\circ\text{C}$ to $85\text{ }^\circ\text{C}$ (Typical values are at $T_A = 25\text{ }^\circ\text{C}$) | Limits - $40\text{ }^\circ\text{C}$ to $85\text{ }^\circ\text{C}$ | | | Unit | |
| | | | Min. ^a | Typ. ^b | Max. ^a | | |
| Operating Voltage ^c | V_{IN} | | 1.1 | - | 5.5 | V | |
| Quiescent Current | I_Q | $V_{IN} = 1.2\text{ V}$, CNTRL = active | - | 6.7 | 14 | μA | |
| | | $V_{IN} = 1.8\text{ V}$, CNTRL = active | - | 14 | 24 | | |
| | | $V_{IN} = 2.5\text{ V}$, CNTRL = active | - | 25 | 40 | | |
| | | $V_{IN} = 3.6\text{ V}$, CNTRL = active | - | 40 | 60 | | |
| | | $V_{IN} = 4.3\text{ V}$, CNTRL = active | - | 52 | 75 | | |
| | | $V_{IN} = 5\text{ V}$, CNTRL = active | - | 71 | 99 | | |
| Off Supply Current | $I_{Q(off)}$ | CNTRL = inactive, OUT = open | - | - | 1 | | |
| Off Switch Current | $I_{DS(off)}$ | CNTRL = inactive, OUT = 0 | - | - | 1 | | |
| Reverse Blocking Current | I_{RB} | $V_{OUT} = 5\text{ V}$, $V_{IN} = 1.2\text{ V}$, $V_{EN} = \text{inactive}$ | - | - | 10 | | |
| On-Resistance | $R_{DS(on)}$ | $V_{IN} = 1.2\text{ V}$, $I_L = 100\text{ mA}$, $T_A = 25\text{ }^\circ\text{C}$ | - | 66 | 76 | $\text{m}\Omega$ | |
| | | $V_{IN} = 1.8\text{ V}$, $I_L = 100\text{ mA}$, $T_A = 25\text{ }^\circ\text{C}$ | - | 62 | 72 | | |
| | | $V_{IN} = 2.5\text{ V}$, $I_L = 100\text{ mA}$, $T_A = 25\text{ }^\circ\text{C}$ | - | 62 | 72 | | |
| | | $V_{IN} = 3.6\text{ V}$, $I_L = 100\text{ mA}$, $T_A = 25\text{ }^\circ\text{C}$ | - | 62 | 72 | | |
| | | $V_{IN} = 4.3\text{ V}$, $I_L = 100\text{ mA}$, $T_A = 25\text{ }^\circ\text{C}$ | - | 62 | 72 | | |
| | | $V_{IN} = 5\text{ V}$, $I_L = 100\text{ mA}$, $T_A = 25\text{ }^\circ\text{C}$ | - | 62 | 72 | | |
| On-Resistance Temp.-Coefficient | TC_{RDS} | | - | 3900 | - | ppm/ $^\circ\text{C}$ | |
| CNTRL Input Low Voltage ^c | V_{IL} | $V_{IN} = 1.2\text{ V}$ | - | - | 0.3 | V | |
| | | $V_{IN} = 1.8\text{ V}$ | - | - | 0.4 ^d | | |
| | | $V_{IN} = 2.5\text{ V}$ | - | - | 0.5 ^d | | |
| | | $V_{IN} = 3.6\text{ V}$ | - | - | 0.6 ^d | | |
| | | $V_{IN} = 4.3\text{ V}$ | - | - | 0.7 ^d | | |
| | | $V_{IN} = 5\text{ V}$ | - | - | 0.8 ^d | | |
| CNTRL Input High Voltage ^c | V_{IH} | $V_{IN} = 1.2\text{ V}$ | 0.9 ^d | - | - | V | |
| | | $V_{IN} = 1.8\text{ V}$ | 1.2 ^d | - | - | | |
| | | $V_{IN} = 2.5\text{ V}$ | 1.4 ^d | - | - | | |
| | | $V_{IN} = 3.6\text{ V}$ | 1.6 ^d | - | - | | |
| | | $V_{IN} = 4.3\text{ V}$ | 1.7 ^d | - | - | | |
| | | $V_{IN} = 5\text{ V}$ | 1.8 | - | - | | |
| EN Input Leakage | I_{SINK} | $V_{EN} = 5.5\text{ V}$ | - | - | 1 | μA | |
| Output Pulldown Resistance | R_{PD} | CNTRL = inactive, $T_A = 25\text{ }^\circ\text{C}$ (SiP32414 and SiP32416 only) | - | 217 | 280 | Ω | |
| Output Turn-On Delay Time | SiP32413, SiP32414 | $t_{d(on)}$ | $V_{IN} = 3.6\text{ V}$, $R_{LOAD} = 10\text{ }\Omega$, $C_{LOAD} = 0.1\text{ }\mu\text{F}$, $T_A = 25\text{ }^\circ\text{C}$ | - | 140 | 210 | μs |
| Output Turn-On Rise Time | | | | 80 | 150 | 220 | |
| Output Turn-Off Delay Time | | | | - | 0.27 | 1 | |
| Output Turn-On Delay Time | SiP32416 | $t_{d(on)}$ | | - | 2 | - | ms |
| Output Turn-On Rise Time | | | | 1.2 | 2.5 | 3.8 | |
| Output Turn-Off Delay Time | | | | - | - | 0.001 | |

Notes:

- a. The algebraic convention whereby the most negative value is a minimum and the most positive a maximum.
- b. Typical values are for DESIGN AID ONLY, not guaranteed nor subject to production testing.
- c. For V_{IN} outside this range consult typical EN threshold curve.
- d. Not tested, guarantee by design.

PIN CONFIGURATION

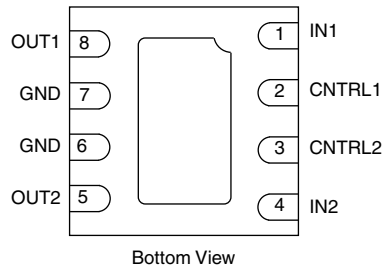

Figure 2 - TDFN8 2 mm x 2 mm Package

| PIN DESCRIPTION | | |
|-----------------|--------|--|
| Pin Number | Name | Function |
| 1 | IN1 | This is the input pin of the switch side 1 |
| 2 | CNTRL1 | This is the control pin of the switch side 1 |
| 3 | CNTRL2 | This is the control pin of the switch side 2 |
| 4 | IN2 | This is the input pin of the switch side 2 |
| 5 | OUT2 | This is the output pin of the switch side 2 |
| 6 | GND | Ground connection |
| 7 | GND | Ground connection |
| 8 | OUT1 | This is the output pin of the switch side 1 |

| TRUTH TABLE SiP32413 | | | |
|----------------------|--------|-----|-----|
| CNTRL1 | CNTRL2 | SW1 | SW2 |
| 0 | 0 | ON | OFF |
| 0 | 1 | ON | ON |
| 1 | 0 | OFF | OFF |
| 1 | 1 | OFF | ON |

| TRUTH TABLE SiP32414, SiP32416 | | | |
|--------------------------------|--------|-----|-----|
| CNTRL1 | CNTRL2 | SW1 | SW2 |
| 0 | 0 | OFF | OFF |
| 0 | 1 | OFF | ON |
| 1 | 0 | ON | OFF |
| 1 | 1 | ON | ON |

TYPICAL CHARACTERISTICS (internally regulated, 25 °C, unless otherwise noted)

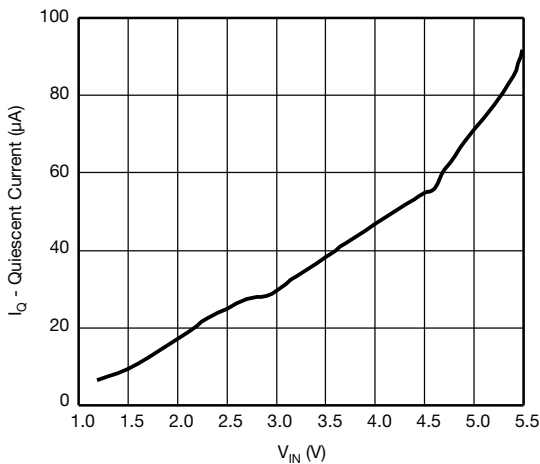

Figure 3 - Quiescent Current vs. Input Voltage

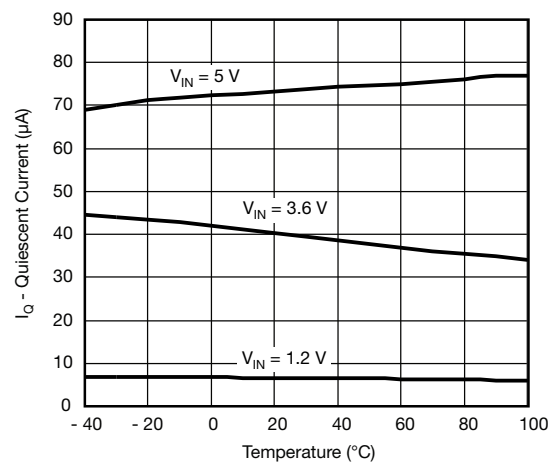

Figure 4 - Quiescent Current vs. Temperature

TYPICAL CHARACTERISTICS (internally regulated, 25 °C, unless otherwise noted)

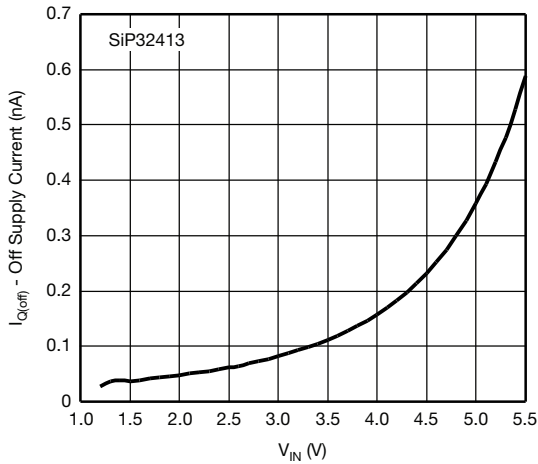

Figure 5 - SiP32413 Off Supply Current vs. V_{IN}

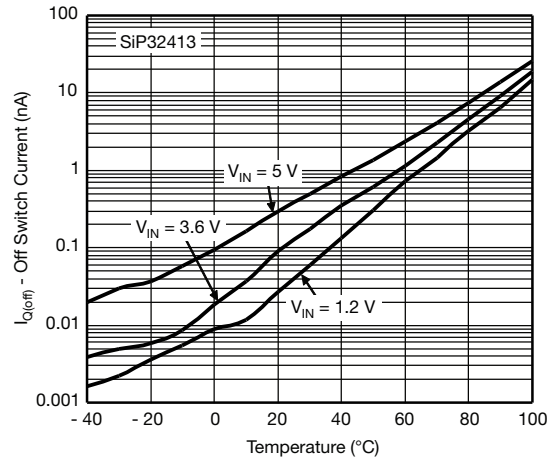

Figure 6 - SiP32414 Off Supply Current vs. Temperature

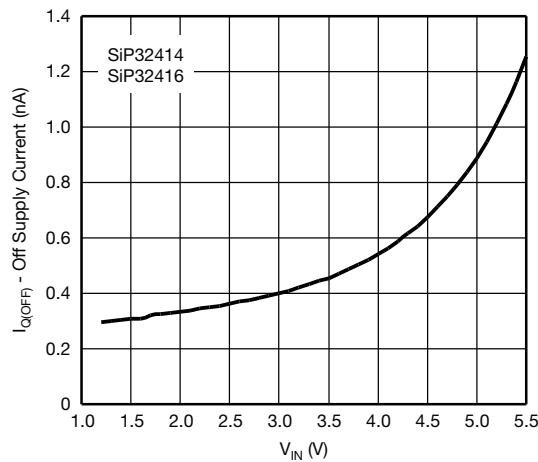

Figure 7 - SiP32414 and SiP32416 Off Supply Current vs. V_{IN}

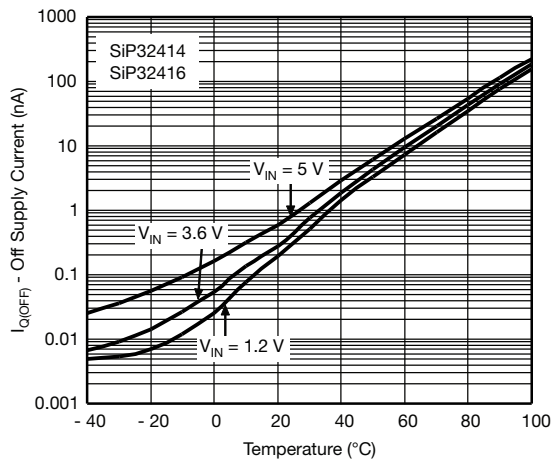

Figure 8 - SiP32414 and SiP32416 Off Supply Current vs. Temperature

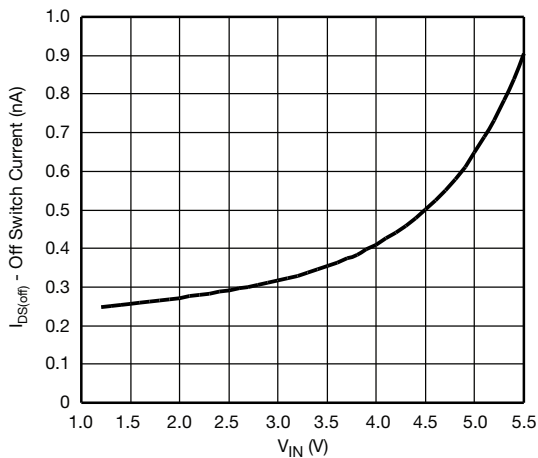

Figure 9 - Off Switch Current vs. Input Voltage

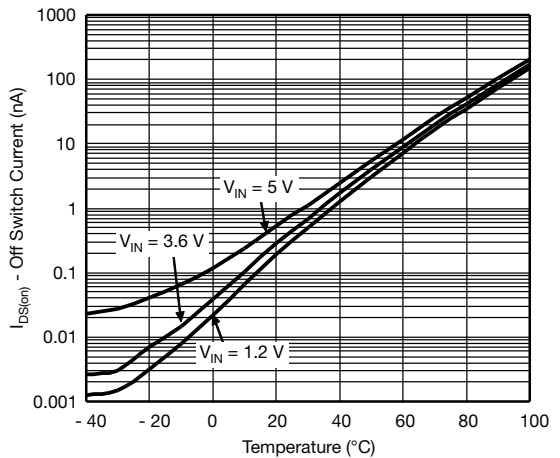

Figure 10 - Off Switch Current vs. Temperature

TYPICAL CHARACTERISTICS (internally regulated, 25 °C, unless otherwise noted)

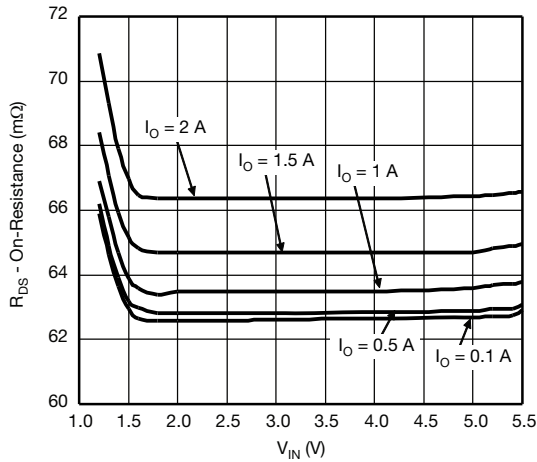

Figure 11 - $R_{DS(on)}$ vs. Input Voltage

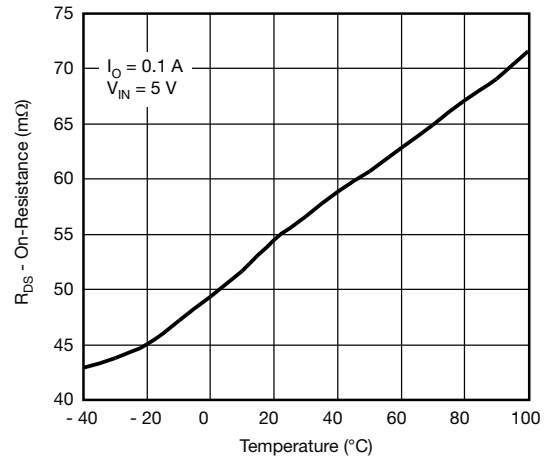

Figure 12 - $R_{DS(on)}$ vs. Temperature

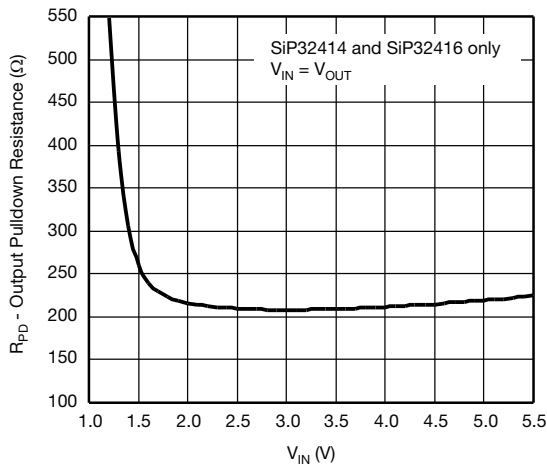

Figure 13 - SiP32414 and SiP32416 Output Pull Down vs. Input Voltage

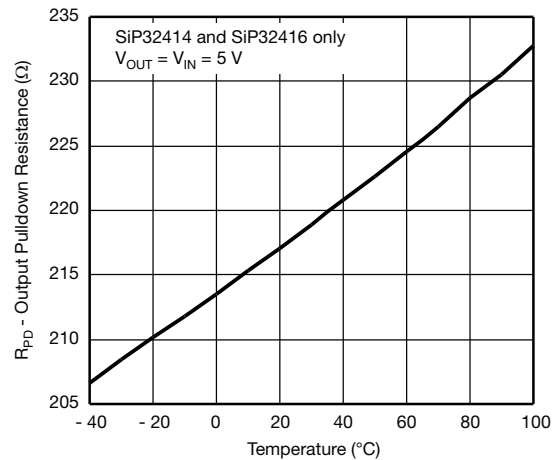

Figure 14 - SiP32414 and SiP32416 Output Pull Down vs. Temperature

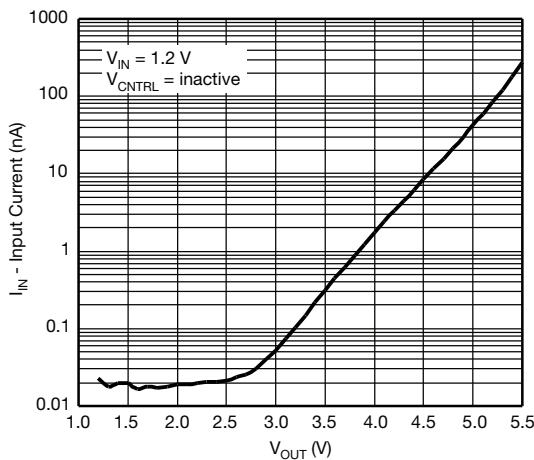

Figure 15 - Reverse Blocking Current vs. Output Voltage

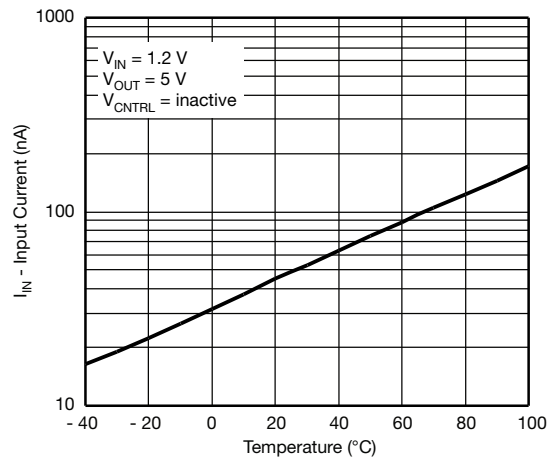

Figure 16 - Reverse Blocking Current vs. Temperature

TYPICAL CHARACTERISTICS (internally regulated, 25 °C, unless otherwise noted)

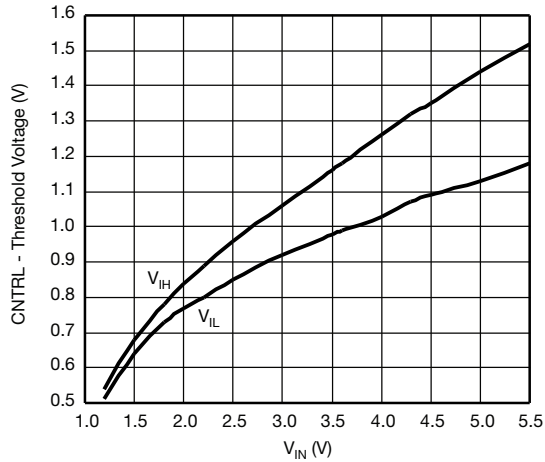

Figure 17 - CNTRL Threshold Voltage vs. Input Voltage

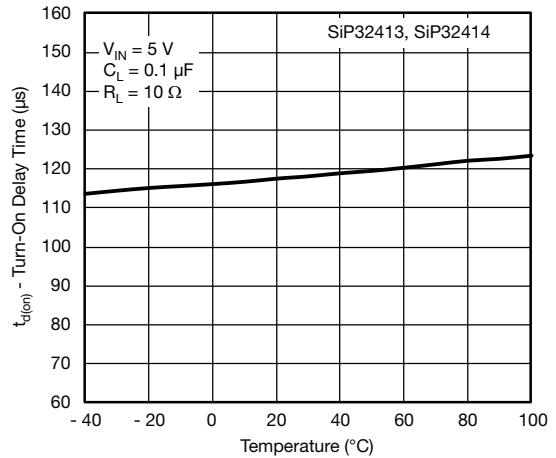

Figure 18 - SiP32413 and SiP32414 Turn-On Delay Time vs. Temperature

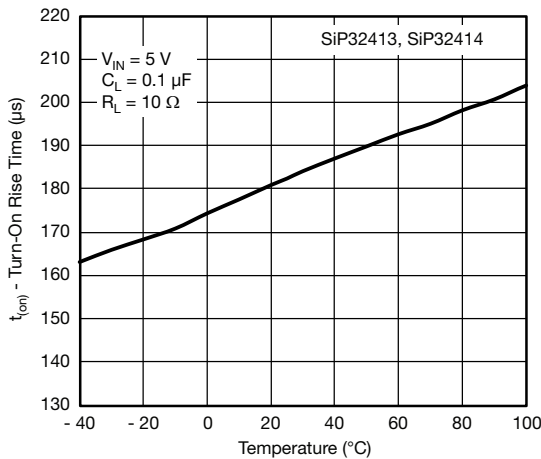

Figure 19 - SiP32413 and SiP32414 Rise Time vs. Temperature

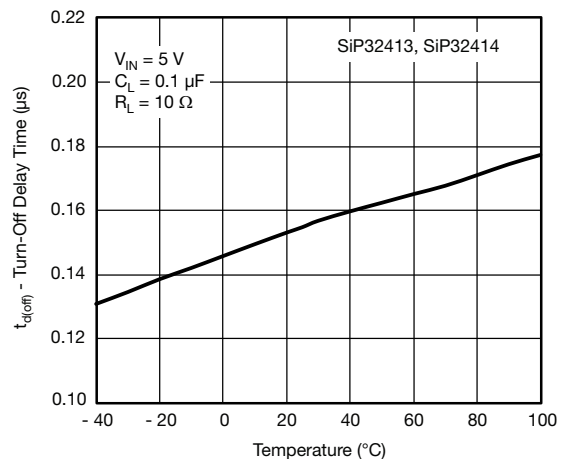

Figure 20 - SiP32413 and SiP32414 Turn-Off Delay Time vs. Temperature

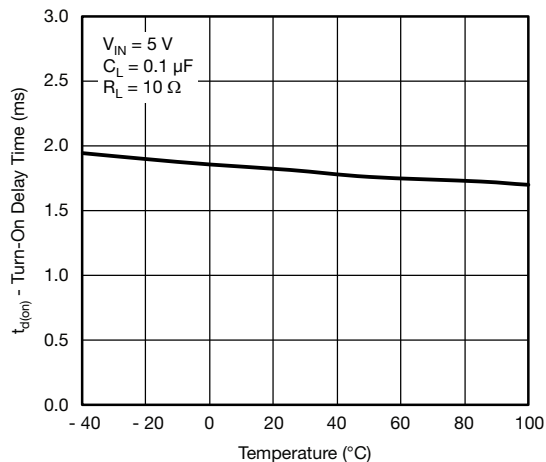

Figure 21 - SiP32416 Turn-On Delay Time vs. Temperature

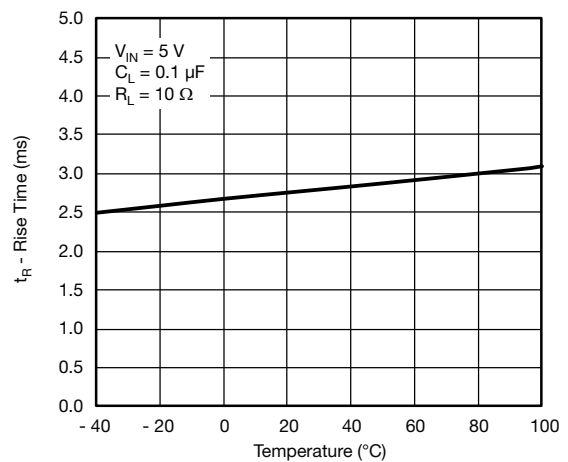

Figure 22 - SiP32416 Rise Time vs. Temperature

TYPICAL CHARACTERISTICS (internally regulated, 25 °C, unless otherwise noted)

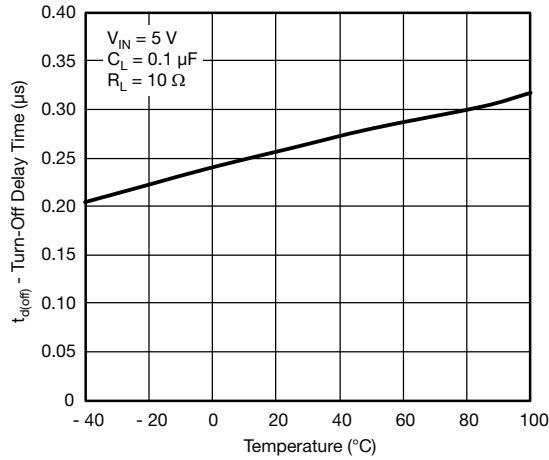

Figure 23 - SiP32416 Turn-Off Delay Time vs. Temperature

TYPICAL WAVEFORMS

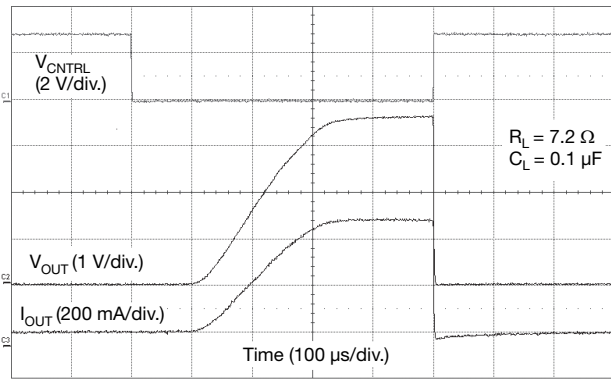

Figure 24 - SiP32413 Channel 1 Switching
($V_{IN} = 3.6 \text{ V}$, $R_L = 7.2 \Omega$)

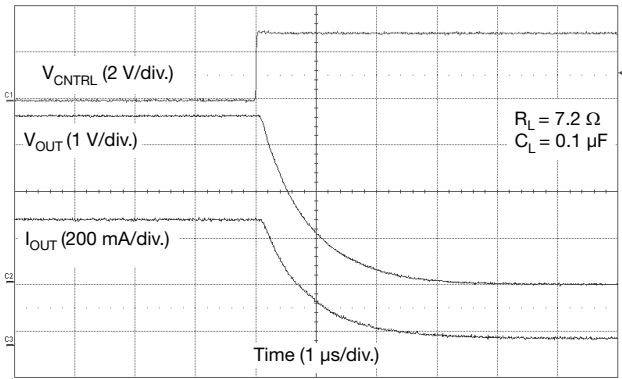

Figure 25 - SiP32413 Channel 1 Turn-Off
($V_{IN} = 3.6 \text{ V}$, $R_L = 7.2 \Omega$)

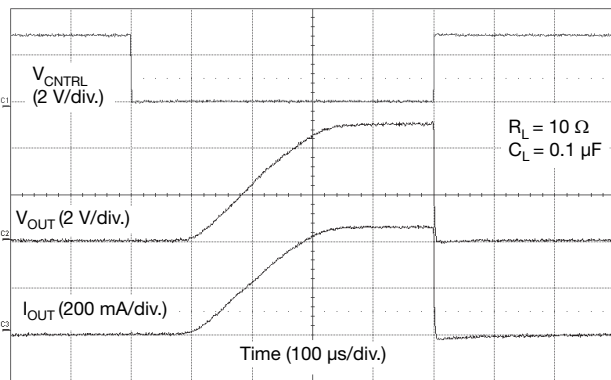

Figure 26 - SiP32413 Channel 1 Switching
($V_{IN} = 5 \text{ V}$, $R_L = 10 \Omega$)

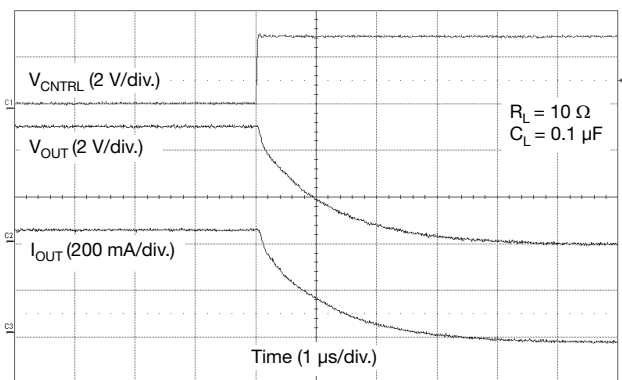

Figure 27 - SiP32413 Channel 1 Turn-Off
($V_{IN} = 5 \text{ V}$, $R_L = 10 \Omega$)

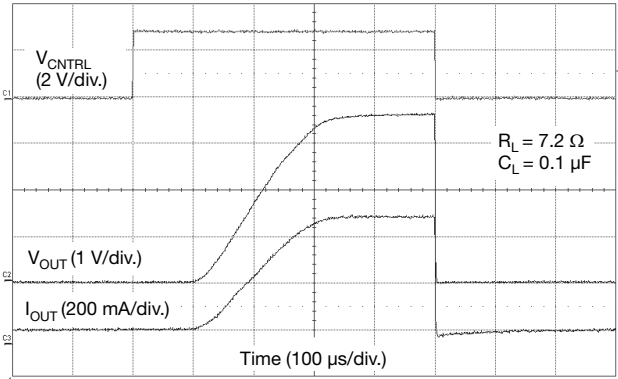

Figure 28 - SiP32413 Channel 2 and SiP32414 Switching
($V_{IN} = 3.6 V$, $R_L = 7.2 \Omega$)

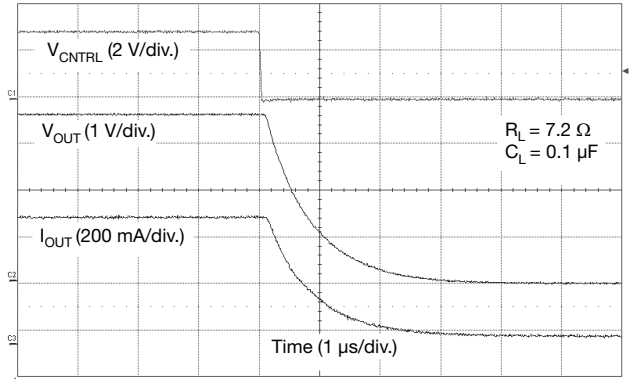

Figure 29 - SiP32413 Channel 2 and SiP32414 Turn-Off
($V_{IN} = 3.6 V$, $R_L = 7.2 \Omega$)

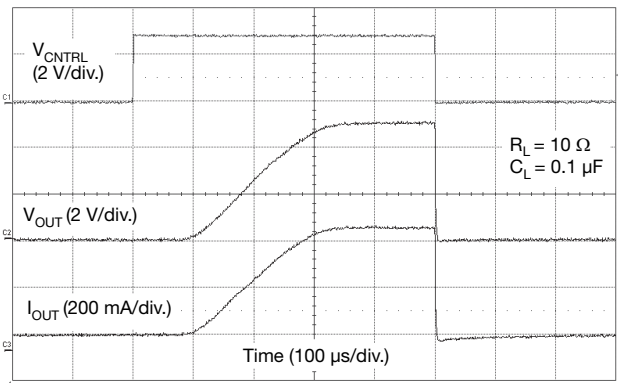

Figure 30 - SiP32413 Channel 2 and SiP32414 Switching
($V_{IN} = 5 V$, $R_L = 10 \Omega$)

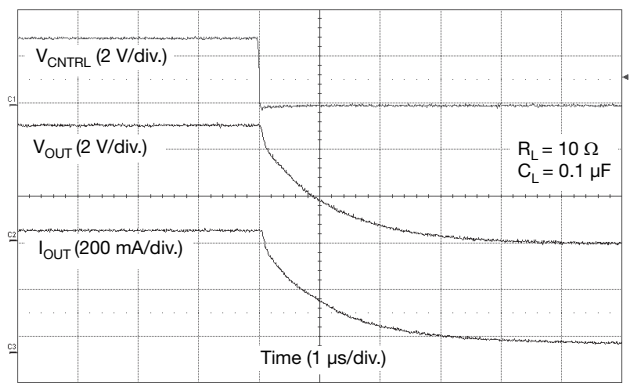

Figure 31 - SiP32413 Channel 2 and SiP32414 Turn-Off
($V_{IN} = 5 V$, $R_L = 10 \Omega$)

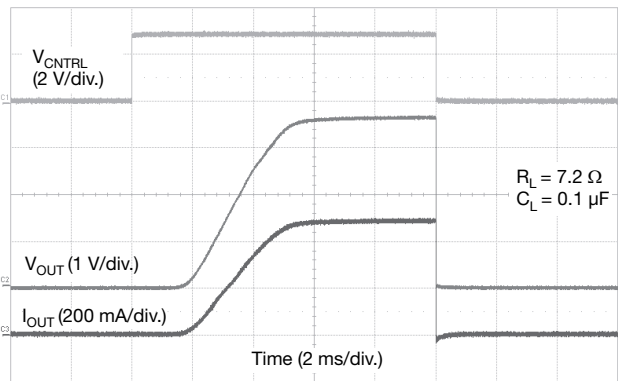

Figure 32 - SiP32416 Switching
($V_{IN} = 3.6 V$, $R_L = 7.2 \Omega$)

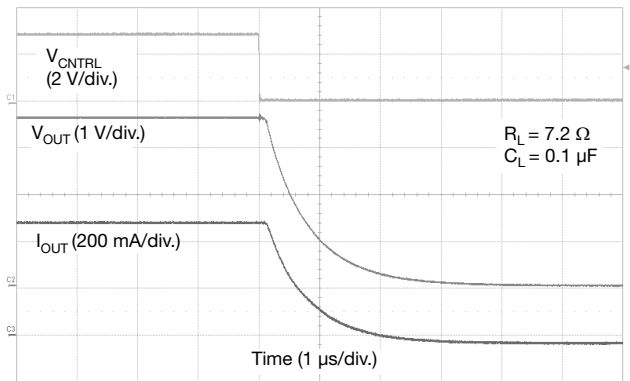

Figure 33 - SiP32416 Turn-Off
($V_{IN} = 3.6 V$, $R_L = 7.2 \Omega$)

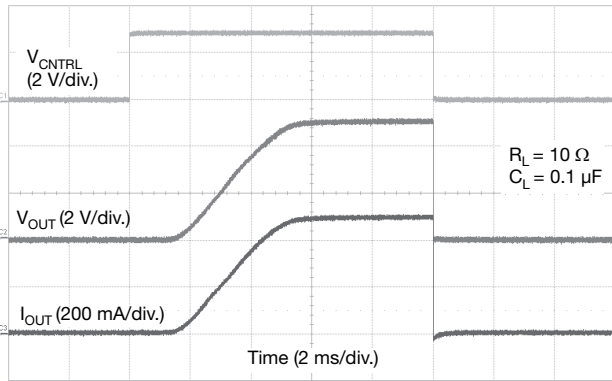

Figure 34 - SiP32416 Switching
($V_{IN} = 5\text{ V}$, $R_L = 10\ \Omega$)

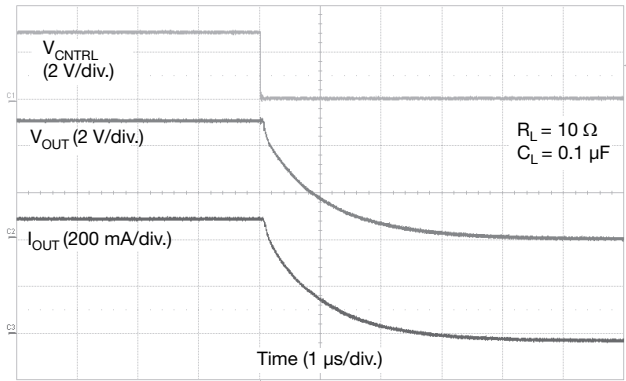

Figure 35 - SiP32416 Turn-Off
($V_{IN} = 5\text{ V}$, $R_L = 10\ \Omega$)

BLOCK DIAGRAM

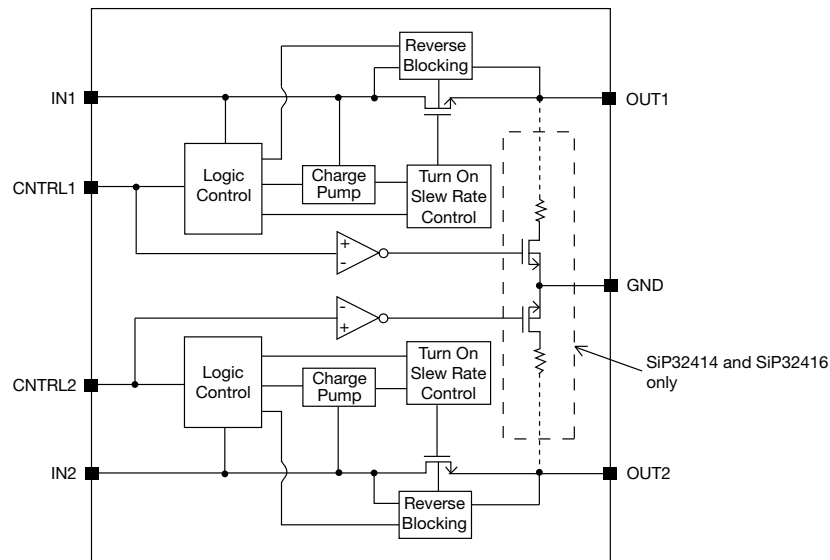

Figure 36 - Functional Block Diagram

PCB LAYOUT

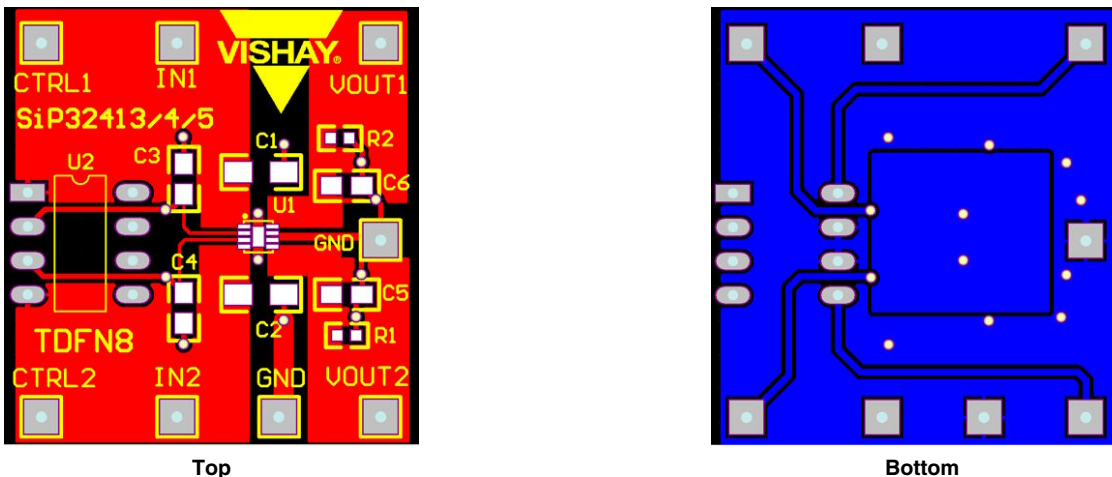

Figure 37 - PCB Layout for TDFN8 2 mm x 2 mm (type: FR4, size: 1.2" x 1.3", thickness: 0.062", copper thickness: 2 oz.)

DETAILED DESCRIPTION

SiP32413, SiP32414 and SiP32416 are dual n-channel power MOSFETs designed as high side load switch with slew rate control to prevent in-rush current. Once enable the device charges the gate of the power MOSFET to 5 V gate to source voltage while controlling the slew rate of the turn on time. The mostly constant gate to source voltage keeps the on resistance low through out the input voltage range. For SiP32414, when disable the output discharge circuit turns on to help pull the output voltage to ground more quickly. For all parts, in disable mode, the reverse blocking circuit is activated to prevent current from going back to the input in case the output voltage is higher than the input voltage. Input voltage is needed for the reverse blocking circuit to work properly, it can be as low as $V_{IN(min)}$.

APPLICATION INFORMATION

Input Capacitor

While bypass capacitors on the inputs are not required, 2.2 μ F or larger capacitors for C_{IN} is recommended in almost all applications. The bypass capacitors should be placed as physically close as possible to the device's input to be effective in minimizing transients on the input. Ceramic capacitors are recommended over tantalum because of their ability to withstand input current surges from low impedance sources such as batteries in portable devices.

Output Capacitor

A 0.1 μ F capacitor or larger across V_{OUT} and GND is recommended to insure proper slew operation. C_{OUT} may be increased without limit to accommodate any load transient condition with only minimal affect on the turn on slew rate time. There are no ESR or capacitor type requirement.

Control

The CNTRL pins are compatible with both TTL and CMOS logic voltage levels.

Protection Against Reverse Voltage Condition

SiP32413, SiP32414 and SiP32416 contain reverse blocking circuitries to protect the current from going to the input from the output in case where the output voltage is higher than the input voltage when the main switch is off. Supply voltages as low as the minimum required input voltage are necessary for these circuitries to work properly.

Thermal Considerations

All three parts are designed to maintain constant output load current. Due to physical limitations of the layout and assembly of the device the maximum switch current is 2.4 A, as stated in the Absolute Maximum Ratings table. However, another limiting characteristic for the safe operating load current is the thermal power dissipation of the package. To obtain the highest power dissipation (and a thermal resistance of 95) the power pad of the device should be connected to a heat sink on the printed circuit board.

The maximum power dissipation in any application is dependant on the maximum junction temperature, $T_{J(max)} = 125\text{ }^{\circ}\text{C}$, the junction-to-ambient thermal resistance for the TDFN4 1.2 mm x 1.6 mm package, $\theta_{J-A} = 95\text{ }^{\circ}\text{C/W}$, and the ambient temperature, T_A , which may be formulaically expressed as:

$$P(\text{max.}) = \frac{T_J(\text{max.}) - T_A}{\theta_{J-A}} = \frac{125 - T_A}{95}$$

It then follows that, assuming an ambient temperature of 70 $^{\circ}\text{C}$, the maximum power dissipation will be limited to about 580 mW.

So long as the load current is below the 2.4 A limit, the maximum continuous switch current becomes a function two things: the package power dissipation and the $R_{DS(ON)}$ at the ambient temperature.

As an example let us calculate the worst case maximum load current at $T_A = 70\text{ }^{\circ}\text{C}$. The worst case $R_{DS(ON)}$ at 25 $^{\circ}\text{C}$ occurs at an input voltage of 1.2 V and is equal to 75 m Ω . The $R_{DS(ON)}$ at 70 $^{\circ}\text{C}$ can be extrapolated from this data using the following formula:

$$R_{DS(ON)}(70\text{ }^{\circ}\text{C}) = R_{DS(ON)}(25\text{ }^{\circ}\text{C}) \times (1 + T_C \times \Delta T)$$

Where T_C is 3400 ppm/ $^{\circ}\text{C}$. Continuing with the calculation we have

$$R_{DS(ON)}(70\text{ }^{\circ}\text{C}) = 75\text{ m}\Omega \times (1 + 0.0034 \times (70\text{ }^{\circ}\text{C} - 25\text{ }^{\circ}\text{C})) = 86.5\text{ m}\Omega$$

The maximum current limit is then determined by

$$I_{LOAD(\text{max.})} < \sqrt{\frac{P(\text{max.})}{R_{DS(ON)}}}$$

which in case is 2.6 A, assuming one switch turn on at a time. Under the stated input voltage condition, if the 2.6 A current limit is exceeded the internal die temperature will rise and eventually, possibly damage the device.

To avoid possible permanent damage to the device and keep a reasonable design margin, it is recommended to operate the device maximum up to 2.4 A only as listed in the Absolute Maximum Ratings table.

Vishay Siliconix maintains worldwide manufacturing capability. Products may be manufactured at one of several qualified locations. Reliability data for Silicon Technology and Package Reliability represent a composite of all qualified locations. For related documents such as package/tape drawings, part marking, and reliability data, see www.vishay.com/ppg?71437.

Case Outline for TDFN8 2 x 2

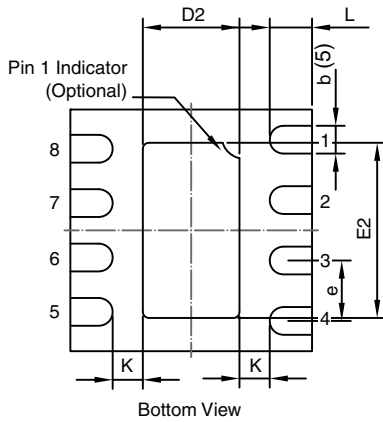
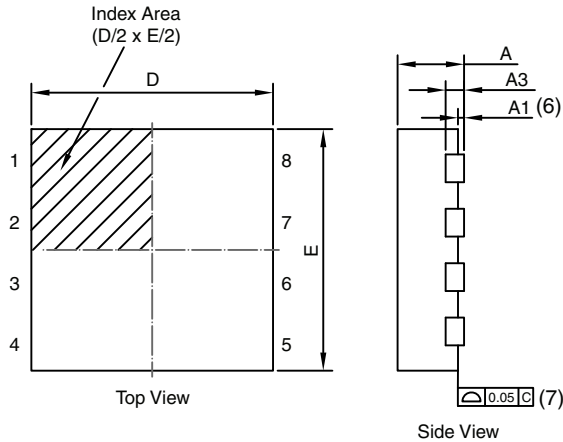

| DIM. | MILLIMETERS | | | INCHES | | |
|------|-------------|------|------|-----------|-------|-------|
| | MIN. | NOM. | MAX. | MIN. | NOM. | MAX. |
| A | 0.50 | 0.55 | 0.60 | 0.020 | 0.022 | 0.024 |
| A1 | 0.00 | - | 0.05 | 0.000 | - | 0.002 |
| A3 | 0.152 REF | | | 0.006 REF | | |
| b | 0.18 | 0.23 | 0.28 | 0.007 | 0.009 | 0.011 |
| D | 1.95 | 2.00 | 2.05 | 0.077 | 0.079 | 0.081 |
| D2 | 0.75 | 0.80 | 0.85 | 0.030 | 0.031 | 0.033 |
| e | 0.50 BSC | | | 0.020 BSC | | |
| E | 1.95 | 2.00 | 2.05 | 0.077 | 0.079 | 0.081 |
| E2 | 1.40 | 1.45 | 1.50 | 0.055 | 0.057 | 0.059 |
| K | - | 0.25 | - | - | 0.010 | - |
| L | 0.30 | 0.35 | 0.40 | 0.012 | 0.014 | 0.016 |

ECN: T15-0301-Rev. B, 29-Jun-15
DWG: 5997

Note

- (1) All dimensions are in millimeters which will govern.
- (2) Max. package warpage is 0.05 mm.
- (3) Max. allowable burrs is 0.076 mm in all directions.
- (4) Pin #1 ID on top will be laser/ink marked.
- (5) Dimension applies to metallized terminal and is measured between 0.20 mm and 0.25 mm from terminal tip.
- (6) Applied only for terminals.
- (7) Applied for exposed pad and terminals.



Disclaimer

ALL PRODUCT, PRODUCT SPECIFICATIONS AND DATA ARE SUBJECT TO CHANGE WITHOUT NOTICE TO IMPROVE RELIABILITY, FUNCTION OR DESIGN OR OTHERWISE.

Vishay Intertechnology, Inc., its affiliates, agents, and employees, and all persons acting on its or their behalf (collectively, "Vishay"), disclaim any and all liability for any errors, inaccuracies or incompleteness contained in any datasheet or in any other disclosure relating to any product.

Vishay makes no warranty, representation or guarantee regarding the suitability of the products for any particular purpose or the continuing production of any product. To the maximum extent permitted by applicable law, Vishay disclaims (i) any and all liability arising out of the application or use of any product, (ii) any and all liability, including without limitation special, consequential or incidental damages, and (iii) any and all implied warranties, including warranties of fitness for particular purpose, non-infringement and merchantability.

Statements regarding the suitability of products for certain types of applications are based on Vishay's knowledge of typical requirements that are often placed on Vishay products in generic applications. Such statements are not binding statements about the suitability of products for a particular application. It is the customer's responsibility to validate that a particular product with the properties described in the product specification is suitable for use in a particular application. Parameters provided in datasheets and / or specifications may vary in different applications and performance may vary over time. All operating parameters, including typical parameters, must be validated for each customer application by the customer's technical experts. Product specifications do not expand or otherwise modify Vishay's terms and conditions of purchase, including but not limited to the warranty expressed therein.

Except as expressly indicated in writing, Vishay products are not designed for use in medical, life-saving, or life-sustaining applications or for any other application in which the failure of the Vishay product could result in personal injury or death. Customers using or selling Vishay products not expressly indicated for use in such applications do so at their own risk. Please contact authorized Vishay personnel to obtain written terms and conditions regarding products designed for such applications.

No license, express or implied, by estoppel or otherwise, to any intellectual property rights is granted by this document or by any conduct of Vishay. Product names and markings noted herein may be trademarks of their respective owners.

单击下面可查看定价，库存，交付和生命周期等信息

[>>Vishay\(威世\)](#)