

## P-Channel 20-V (D-S) MOSFET with Schottky Diode

PRODUCT SUMMARY		
$V_{DS}$ (V)	$R_{DS(on)}$ ( $\Omega$ )	$I_D$ (A)
- 20	0.200 at $V_{GS} = - 4.5$ V	$\pm 1.8$
	0.340 at $V_{GS} = - 2.5$ V	$\pm 1.3$

SCHOTTKY PRODUCT SUMMARY		
$V_{KA}$ (V)	$V_F$ (V) Diode Forward Voltage	$I_F$ (A)
20	0.48 V at 0.5 A	0.5

### FEATURES

- Halogen-free According to IEC 61249-2-21 Definition
- LITTLE FOOT® Plus
- Compliant to RoHS Directive 2002/95/EC



**RoHS**  
COMPLIANT  
HALOGEN  
**FREE**  
Available

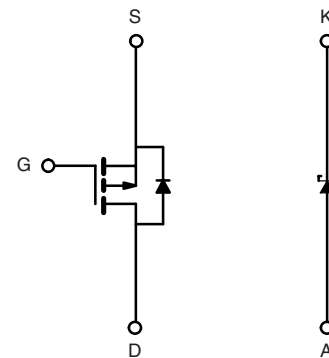
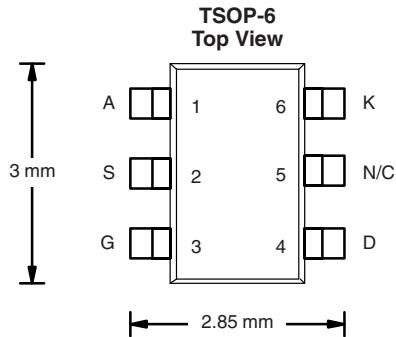

P-Channel MOSFET

Ordering Information: Si3853DV-T1-E3 (Lead (Pb)-free)  
Si3853DV-T1-GE3 (Lead (Pb)-free and Halogen-free)

ABSOLUTE MAXIMUM RATINGS $T_A = 25$ °C, unless otherwise noted					
Parameter	Symbol	5 s	Steady State	Unit	
Drain-Source Voltage (MOSFET and Schottky)	$V_{DS}$	- 20		V	
Reverse Voltage (Schottky)	$V_{KA}$	20			
Gate-Source Voltage (MOSFET)	$V_{GS}$	$\pm 12$	$\pm 12$		
Continuous Drain Current ( $T_J = 150$ °C) (MOSFET) <sup>a</sup>	$I_D$	$T_A = 25$ °C	$\pm 1.8$	$\pm 1.6$	
		$T_A = 70$ °C	$\pm 1.5$	$\pm 1.2$	
Pulsed Drain Current (MOSFET)	$I_{DM}$	$\pm 7$		A	
Continuous Source Current (MOSFET Diode Conduction) <sup>a</sup>	$I_S$	- 1.05	- 0.75		
Average Forward Current (Schottky)	$I_F$	0.5			
Pulsed Forward Current (Schottky)	$I_{FM}$	7		W	
Maximum Power Dissipation (MOSFET) <sup>a</sup>	$P_D$	$T_A = 25$ °C	1.15		0.83
		$T_A = 70$ °C	0.73		0.53
Maximum Power Dissipation (Schottky) <sup>a</sup>	$P_D$	$T_A = 25$ °C	1.0		0.76
		$T_A = 70$ °C	0.64	0.48	
Operating Junction and Storage Temperature Range	$T_J, T_{stg}$	- 55 to 150		°C	

Notes:

a. Surface mounted on 1" x 1" FR4 board.

THERMAL RESISTANCE RATINGS						
Parameter		Device	Symbol	Typical	Maximum	Unit
Junction-to-Ambient <sup>a</sup>	t ≤ 5 s	MOSFET	R <sub>thJA</sub>	93	110	°C/W
		Schottky		103	125	
	Steady State	MOSFET		130	150	
		Schottky		140	165	
Junction-to-Foot	Steady State	MOSFET	R <sub>thJF</sub>	75	90	
		MOSFET		80	95	

Notes:

a. Surface mounted on 1" x 1" FR4 board.

MOSFET SPECIFICATIONS T <sub>J</sub> = 25 °C, unless otherwise noted						
Parameter	Symbol	Test Conditions	Min.	Typ.	Max.	Unit
<b>Static</b>						
Gate Threshold Voltage	V <sub>GS(th)</sub>	V <sub>DS</sub> = V <sub>GS</sub> , I <sub>D</sub> = - 250 μA	- 0.5			V
Gate-Body Leakage	I <sub>GSS</sub>	V <sub>DS</sub> = 0 V, V <sub>GS</sub> = ± 12 V			± 100	nA
Zero Gate Voltage Drain Current	I <sub>DSS</sub>	V <sub>DS</sub> = - 16 V, V <sub>GS</sub> = 0 V			- 1	μA
		V <sub>DS</sub> = - 16 V, V <sub>GS</sub> = 0 V, T <sub>J</sub> = 75 °C			- 10	
On-State Drain Current <sup>a</sup>	I <sub>D(on)</sub>	V <sub>DS</sub> ≥ - 5 V, V <sub>GS</sub> = - 4.5 V	- 5			A
Drain-Source On-State Resistance <sup>a</sup>	R <sub>DS(on)</sub>	V <sub>GS</sub> = - 4.5 V, I <sub>D</sub> = - 1.8 A		0.160	0.200	Ω
		V <sub>GS</sub> = - 2.5 V, I <sub>D</sub> = - 1.0 A		0.280	0.340	
Forward Transconductance <sup>a</sup>	g <sub>fs</sub>	V <sub>DS</sub> = - 5 V, I <sub>D</sub> = - 1.8 A		3.6		S
Diode Forward Voltage <sup>a</sup>	V <sub>SD</sub>	I <sub>S</sub> = - 1.05 V, V <sub>GS</sub> = 0 V		- 0.83	- 1.10	V
<b>Dynamic<sup>b</sup></b>						
Total Gate Charge	Q <sub>g</sub>	V <sub>DS</sub> = - 10 V, V <sub>GS</sub> = - 4.5 V, I <sub>D</sub> = - 1.8 A		2.7	4.0	nC
Gate-Source Charge	Q <sub>gs</sub>			0.4		
Gate-Drain Charge	Q <sub>gd</sub>			0.6		
Turn-On Delay Time	t <sub>d(on)</sub>	V <sub>DD</sub> = - 10 V, R <sub>L</sub> = 10 Ω I <sub>D</sub> = - 1 A, V <sub>GEN</sub> = - 4.5 V, R <sub>g</sub> = 6 Ω		11	17	ns
Rise Time	t <sub>r</sub>			34	50	
Turn-Off Delay Time	t <sub>d(off)</sub>			19	30	
Fall Time	t <sub>f</sub>			24	36	
Body Diode Reverse Recovery Time	t <sub>rr</sub>	I <sub>F</sub> = - 1.05 A, dI/dt = 100 A/μs		20	40	

Notes:

a. Pulse test; pulse width ≤ 300 μs, duty cycle ≤ 2 %.

b. Guaranteed by design, not subject to production testing.

SCHOTTKY SPECIFICATIONS T <sub>J</sub> = 25 °C, unless otherwise noted						
Parameter	Symbol	Test Conditions	Min.	Typ.	Max.	Unit
Forward Voltage Drop	V <sub>F</sub>	I <sub>F</sub> = 0.5 A		0.42	0.48	V
		I <sub>F</sub> = 0.5 A, T <sub>J</sub> = 125 °C		0.33	0.4	
Maximum Reverse Leakage Current	I <sub>rm</sub>	V <sub>R</sub> = 20 V		0.002	0.100	mA
		V <sub>R</sub> = 20 V, T <sub>J</sub> = 75 °C		0.06	1	
		V <sub>R</sub> = 20 V, T <sub>J</sub> = 125 °C		1.5	10	
Junction Capacitance	C <sub>T</sub>	V <sub>R</sub> = 10 V		31		pF

Stresses beyond those listed under "Absolute Maximum Ratings" may cause permanent damage to the device. These are stress ratings only, and functional operation of the device at these or any other conditions beyond those indicated in the operational sections of the specifications is not implied. Exposure to absolute maximum rating conditions for extended periods may affect device reliability.

## MOSFET TYPICAL CHARACTERISTICS $T_A = 25\text{ }^\circ\text{C}$ , unless otherwise noted

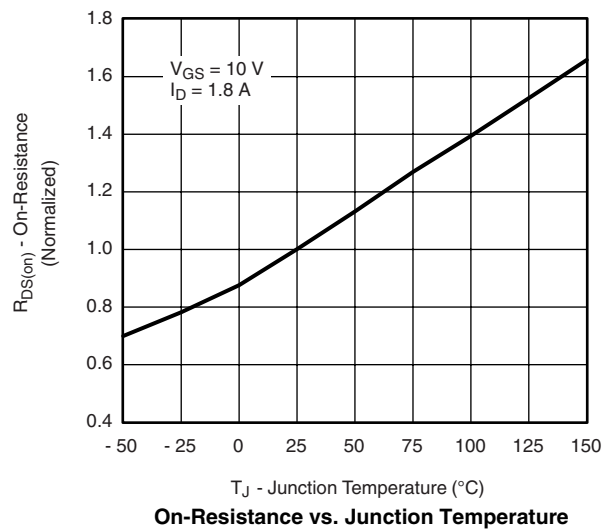
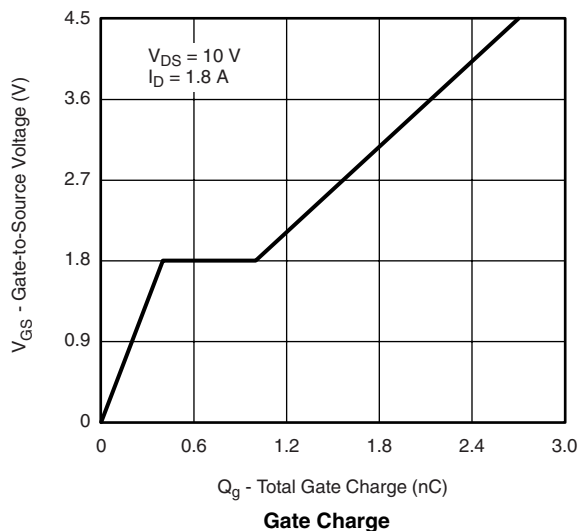
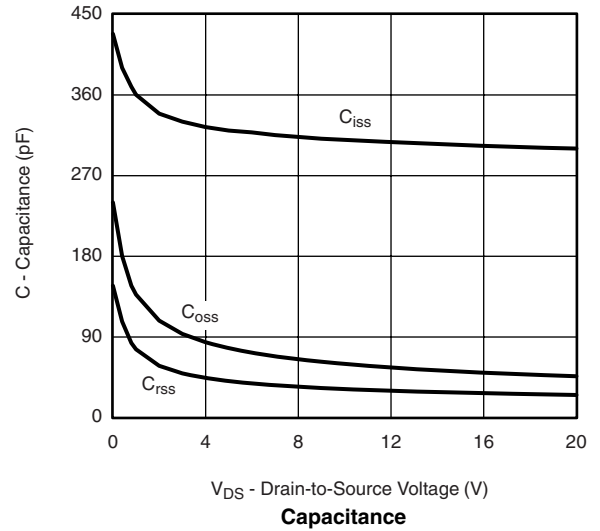
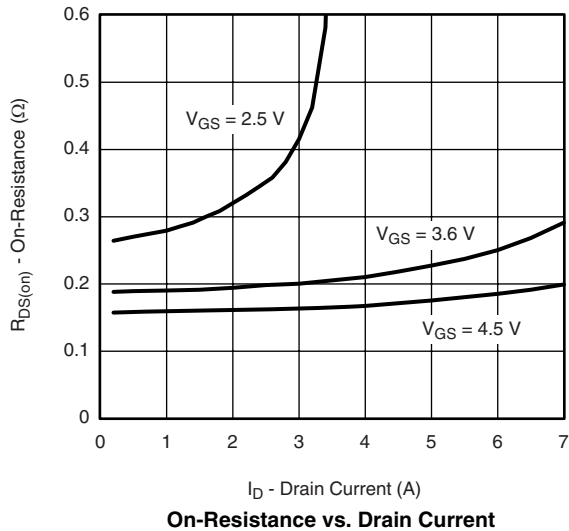
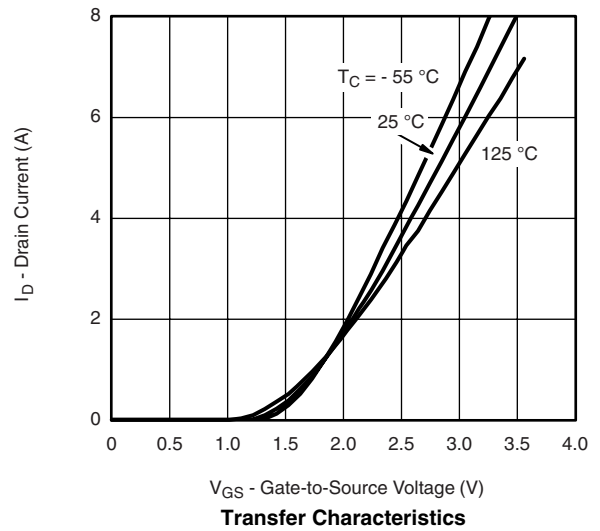
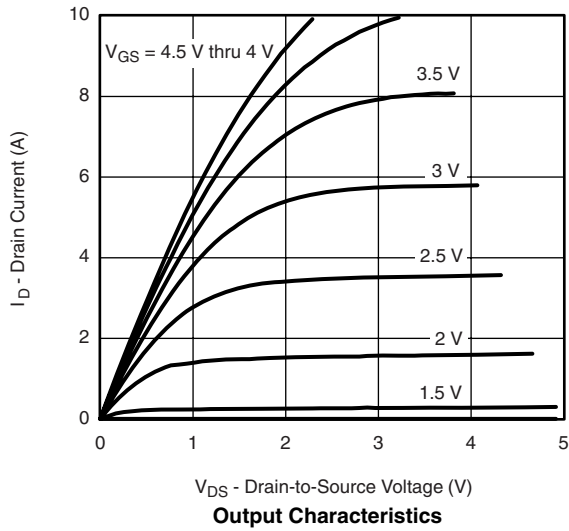

**MOSFET TYPICAL CHARACTERISTICS**  $T_A = 25\text{ }^\circ\text{C}$ , unless otherwise noted

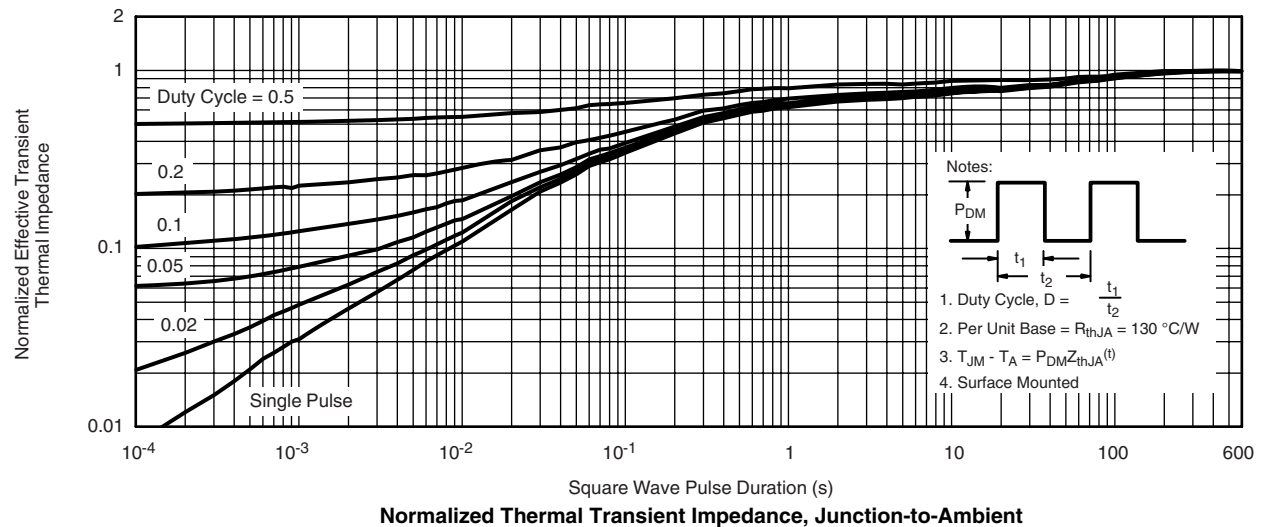
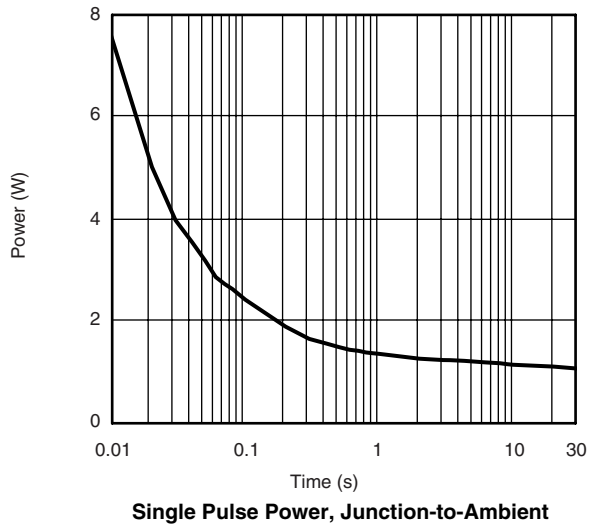
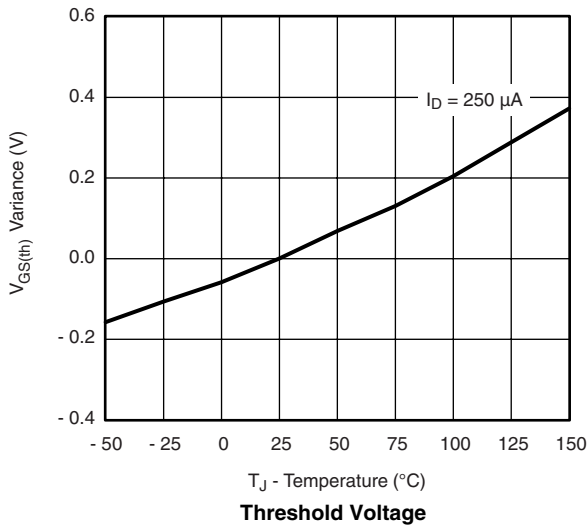
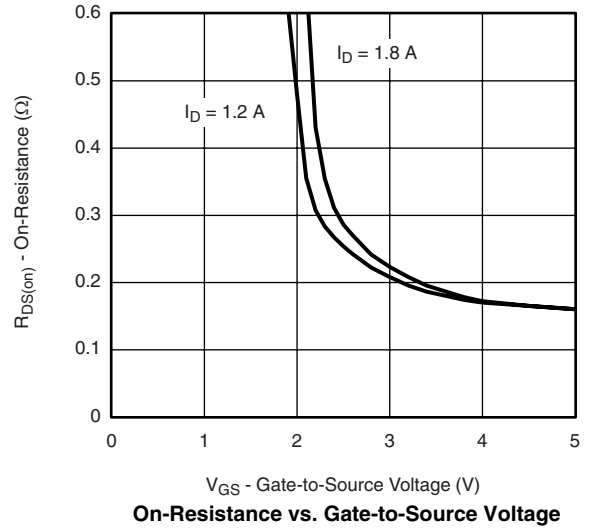
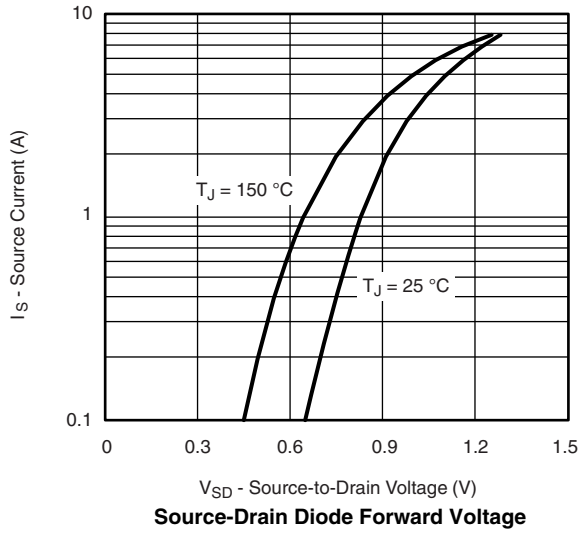

**MOSFET TYPICAL CHARACTERISTICS**  $T_A = 25\text{ }^\circ\text{C}$ , unless otherwise noted

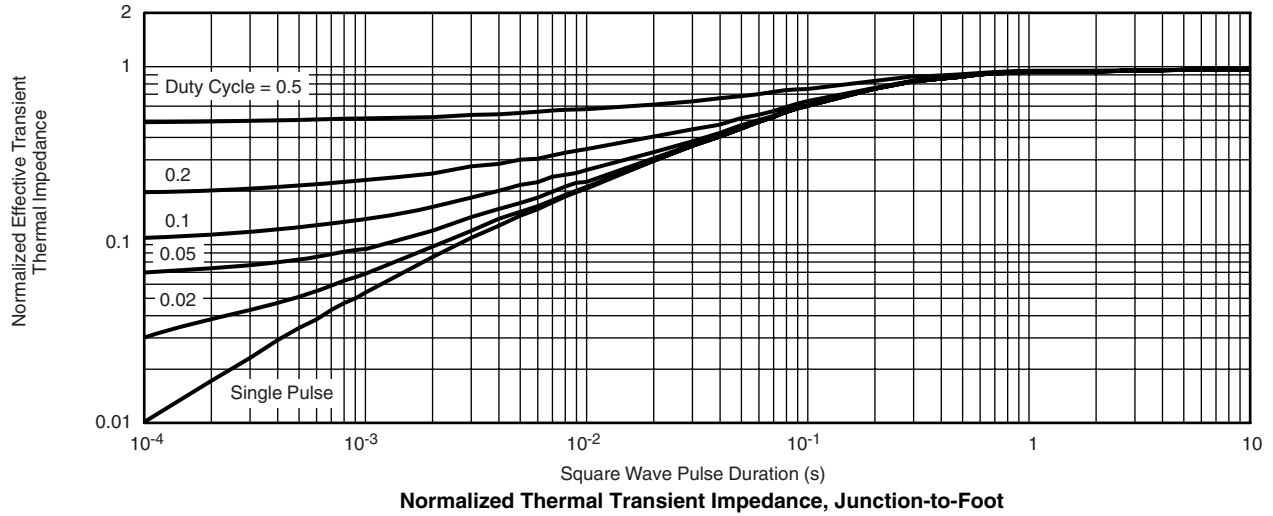

**SCHOTTKY TYPICAL CHARACTERISTICS**  $T_A = 25\text{ }^\circ\text{C}$ , unless otherwise noted

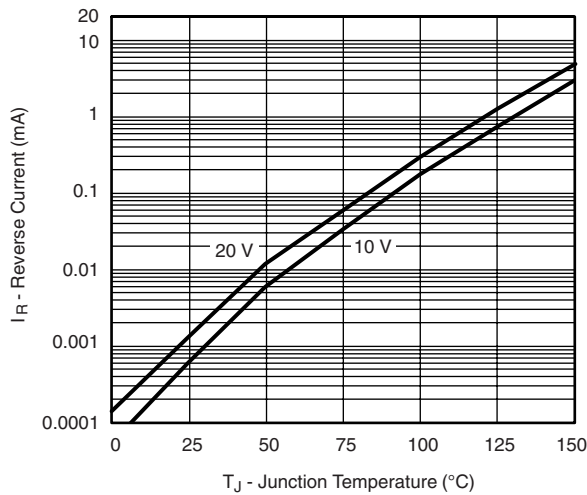

Reverse Current vs. Junction Temperature

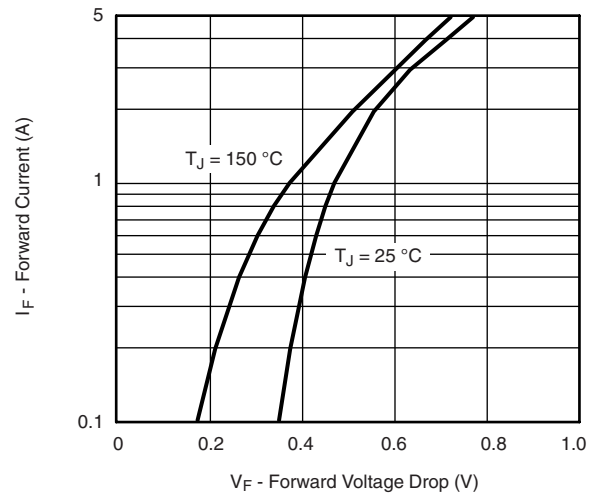

Forward Voltage Drop

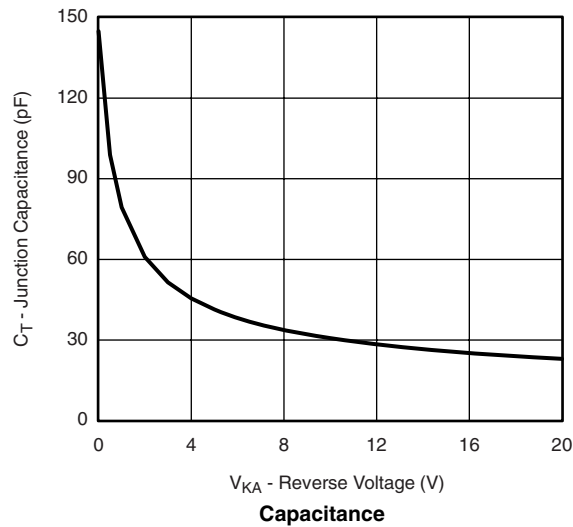

**SCHOTTKY TYPICAL CHARACTERISTICS**  $T_A = 25\text{ }^\circ\text{C}$ , unless otherwise noted

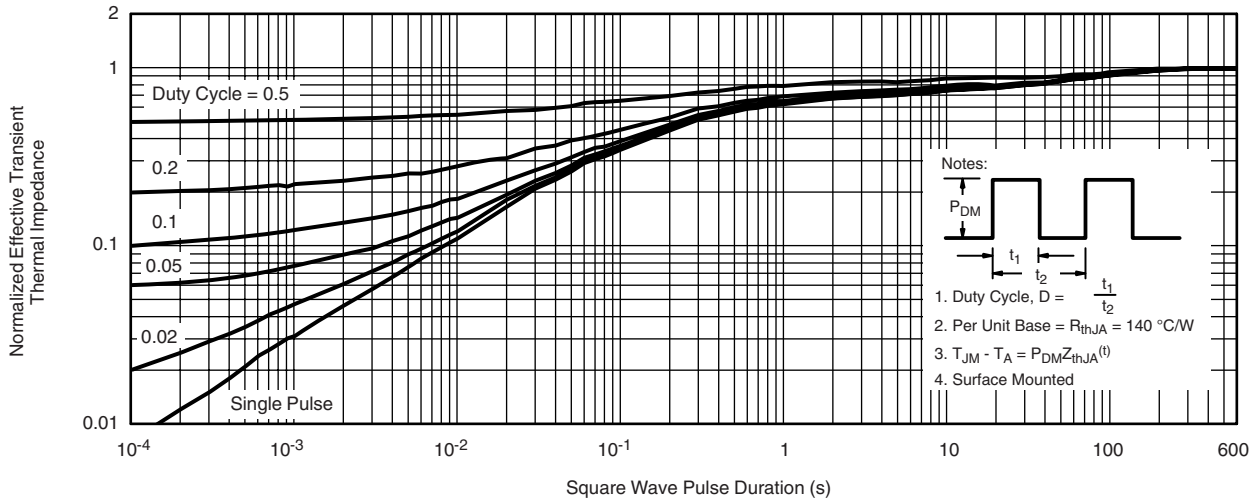

Normalized Thermal Transient Impedance, Junction-to-Ambient

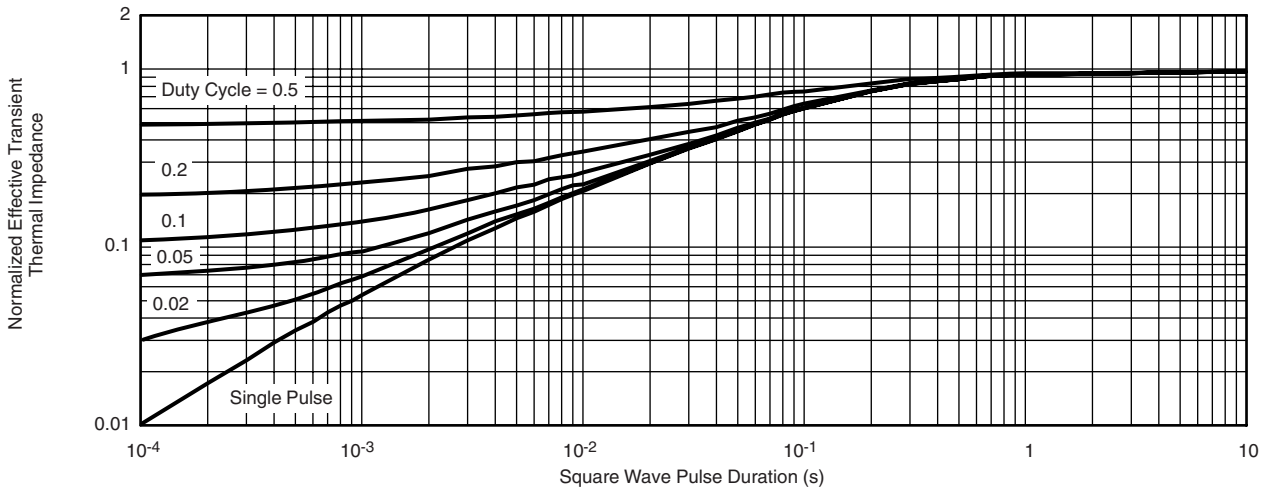

Normalized Thermal Transient Impedance, Junction-to-Foot

Vishay Siliconix maintains worldwide manufacturing capability. Products may be manufactured at one of several qualified locations. Reliability data for Silicon Technology and Package Reliability represent a composite of all qualified locations. For related documents such as package/tape drawings, part marking, and reliability data, see [www.vishay.com/ppg?70979](http://www.vishay.com/ppg?70979).



## **Disclaimer**

ALL PRODUCT, PRODUCT SPECIFICATIONS AND DATA ARE SUBJECT TO CHANGE WITHOUT NOTICE TO IMPROVE RELIABILITY, FUNCTION OR DESIGN OR OTHERWISE.

Vishay Intertechnology, Inc., its affiliates, agents, and employees, and all persons acting on its or their behalf (collectively, "Vishay"), disclaim any and all liability for any errors, inaccuracies or incompleteness contained in any datasheet or in any other disclosure relating to any product.

Vishay makes no warranty, representation or guarantee regarding the suitability of the products for any particular purpose or the continuing production of any product. To the maximum extent permitted by applicable law, Vishay disclaims (i) any and all liability arising out of the application or use of any product, (ii) any and all liability, including without limitation special, consequential or incidental damages, and (iii) any and all implied warranties, including warranties of fitness for particular purpose, non-infringement and merchantability.

Statements regarding the suitability of products for certain types of applications are based on Vishay's knowledge of typical requirements that are often placed on Vishay products in generic applications. Such statements are not binding statements about the suitability of products for a particular application. It is the customer's responsibility to validate that a particular product with the properties described in the product specification is suitable for use in a particular application. Parameters provided in datasheets and / or specifications may vary in different applications and performance may vary over time. All operating parameters, including typical parameters, must be validated for each customer application by the customer's technical experts. Product specifications do not expand or otherwise modify Vishay's terms and conditions of purchase, including but not limited to the warranty expressed therein.

Except as expressly indicated in writing, Vishay products are not designed for use in medical, life-saving, or life-sustaining applications or for any other application in which the failure of the Vishay product could result in personal injury or death. Customers using or selling Vishay products not expressly indicated for use in such applications do so at their own risk. Please contact authorized Vishay personnel to obtain written terms and conditions regarding products designed for such applications.

No license, express or implied, by estoppel or otherwise, to any intellectual property rights is granted by this document or by any conduct of Vishay. Product names and markings noted herein may be trademarks of their respective owners.

单击下面可查看定价，库存，交付和生命周期等信息

[>>Vishay\(威世\)](#)