

## Standard Avalanche Surface Mount Rectifiers

### eSMP® Series

**SMP (DO-220AA)**

Cathode Anode

### ADDITIONAL RESOURCES

[3D Models](#)

PRIMARY CHARACTERISTICS	
$I_{F(AV)}$	1.5 A
$V_{RRM}$	200 V, 400 V, 600 V, 800 V, 1000 V
$I_{FSM}$	30 A
$I_R$	0.3 $\mu$ A
$V_F$ at $I_F = 1.5$ A	0.89 V
$E_{AS}$	20 mJ
$T_J$ max.	175 °C
Package	SMP (DO-220AA)
Circuit configuration	Single

### FEATURES

- Glass passivated pellet chip junction
- Very low profile - typical height of 1.0 mm
- Ideal for automated placement
- Controlled avalanche characteristics
- Low forward voltage drop
- Low leakage current
- Meets MSL level 1, per J-STD-020; LF maximum peak of 260 °C
- AEC-Q101 qualified
- Material categorization: for definitions of compliance please see [www.vishay.com/doc?99912](http://www.vishay.com/doc?99912)

**RoHS**  
 COMPLIANT  
 HALOGEN  
**FREE**

### TYPICAL APPLICATIONS

For use in general purpose rectification of power supplies, inverters, converters, and freewheeling diodes for consumer, automotive, and telecommunication.

### MECHANICAL DATA

#### Case: SMP (DO-220AA)

Molding compound meets UL 94 V-0 flammability rating  
 Base P/N-M3 - halogen-free, RoHS-compliant, and commercial grade

Base P/NHM3 - halogen-free, RoHS-compliant, and automotive grade

**Terminals:** matte tin plated leads, solderable per J-STD-002 and JESD 22-B102

M3 suffix meets JESD 201 class 1A whisker test, HM3 suffix meets JESD 201 class 2 whisker test

**Polarity:** color band denotes cathode end

MAXIMUM RATINGS ( $T_A = 25$ °C unless otherwise noted)							
PARAMETER	SYMBOL	AS1PD	AS1PG	AS1PJ	AS1PK	AS1PM	UNIT
Device marking code		ASD	ASG	ASJ	ASK	ASM	
Max. repetitive peak reverse voltage	$V_{RRM}$	200	400	600	800	1000	V
Max. DC forward current (see fig. 1)	$I_F^{(1)}$	1.5					A
Peak forward surge current 10 ms single half sine-wave superimposed on rated load	$I_{FSM}$	30					A
Non-repetitive avalanche energy at $I_{AS} = 1.0$ A, $T_A = 25$ °C	$E_{AS}$	20					mJ
Operating junction and storage temperature range	$T_J, T_{STG}$	-55 to +175					°C

#### Note

(1) Mounted on 5 mm x 5 mm pad areas PCB



ELECTRICAL CHARACTERISTICS (T <sub>A</sub> = 25 °C unless otherwise noted)					
PARAMETER	TEST CONDITIONS	SYMBOL	TYP.	MAX.	UNIT
Instantaneous forward voltage	I <sub>F</sub> = 1.0 A	T <sub>A</sub> = 25 °C	0.95	-	V
		T <sub>A</sub> = 125 °C	0.84	-	
	I <sub>F</sub> = 1.5 A	T <sub>A</sub> = 25 °C	0.99	1.15	
		T <sub>A</sub> = 125 °C	0.89	1.0	
Reverse current	Rated V <sub>R</sub>	T <sub>A</sub> = 25 °C	0.3	5	μA
		T <sub>A</sub> = 125 °C	35	100	
Typical reverse recovery time	I <sub>F</sub> = 0.5 A, I <sub>R</sub> = 1.0 A, I <sub>rr</sub> = 0.25 A	t <sub>rr</sub>	1.5	-	μs
Typical junction capacitance	4.0 V, 1 MHz	C <sub>J</sub>	10.4	-	pF

**Notes**

- (1) Pulse test: 300 μs pulse width, 1 % duty cycle
- (2) Pulse test: Pulse width ≤ 40 ms

THERMAL CHARACTERISTICS (T <sub>A</sub> = 25 °C unless otherwise noted)							
PARAMETER	SYMBOL	AS1PD	AS1PG	AS1PJ	AS1PK	AS1PM	UNIT
Typical thermal resistance	R <sub>θJA</sub> (1)	115					°C/W
	R <sub>θJM</sub> (1)	15					

**Note**

- (1) Unit mounted on PCB with 5 mm x 5 mm copper pad areas. Thermal resistance R<sub>θJA</sub> - junction to ambient, R<sub>θJM</sub> - junction to mount at the terminal of cathode band

ORDERING INFORMATION (Example)				
PREFERRED P/N	UNIT WEIGHT (g)	PREFERRED PACKAGE CODE	BASE QUANTITY	DELIVERY MODE
AS1PJ-M3/84A	0.024	84A	3000	7" diameter plastic tape and reel
AS1PJ-M3/85A	0.024	85A	10 000	13" diameter plastic tape and reel
AS1PJHM3/84A (1)	0.024	84A	3000	7" diameter plastic tape and reel
AS1PJHM3/85A (1)	0.024	85A	10 000	13" diameter plastic tape and reel

**Note**

- (1) AEC-Q101 qualified

**RATINGS AND CHARACTERISTICS CURVES (T<sub>A</sub> = 25 °C unless otherwise noted)**

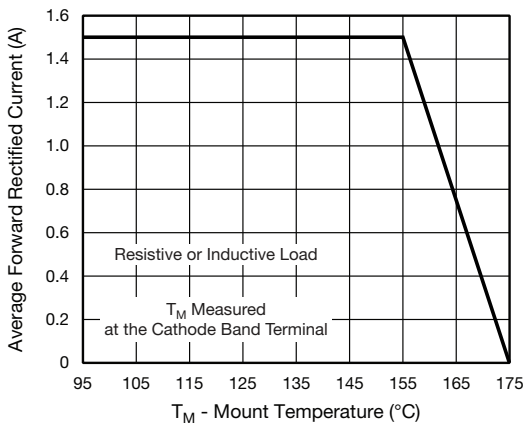

Fig. 1 - Max. Forward Current Derating Curve

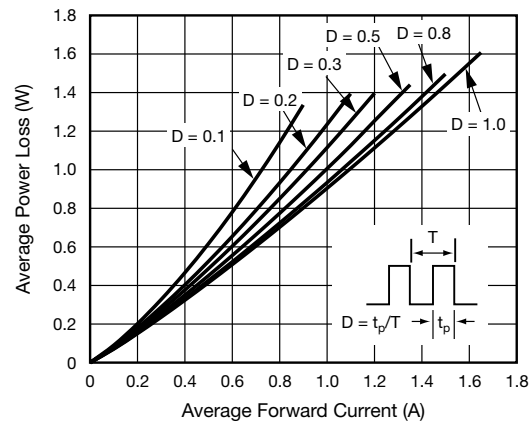

Fig. 2 - Forward Power Loss Characteristics

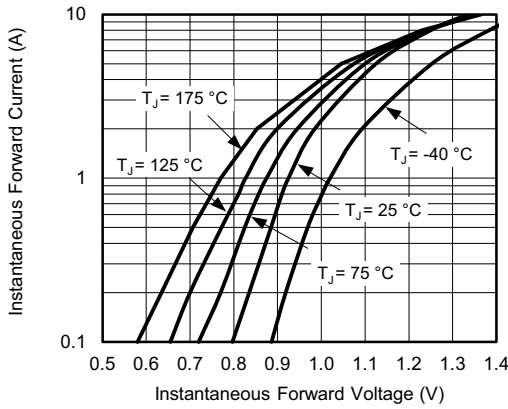

Fig. 3 - Typical Instantaneous Forward Characteristics

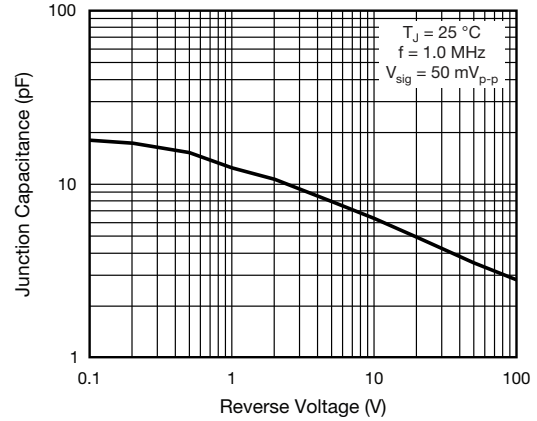

Fig. 5 - Typical Junction Capacitance

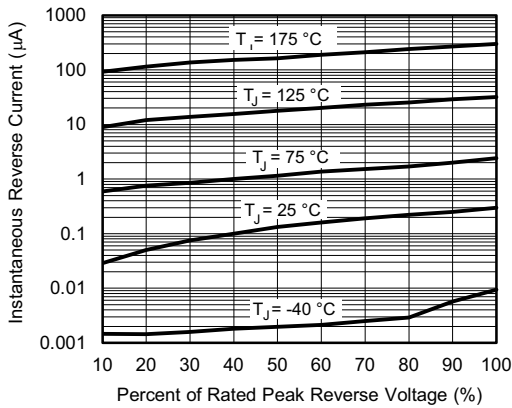

Fig. 4 - Typical Reverse Characteristics

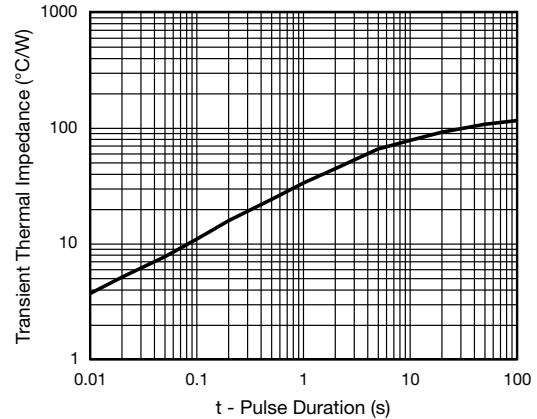
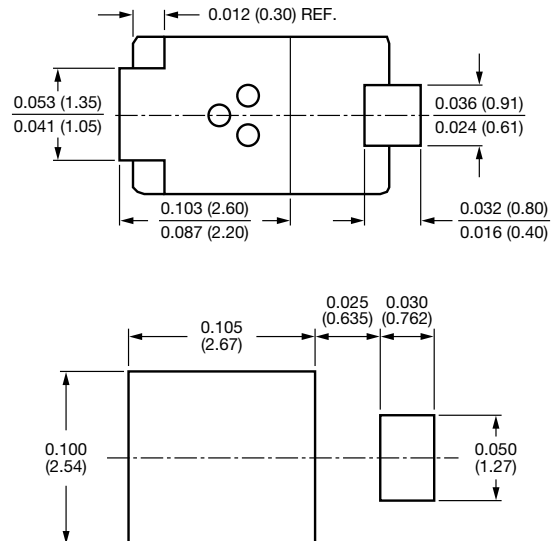
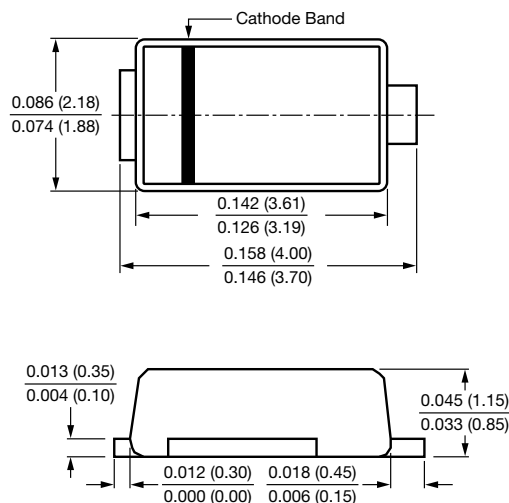

Fig. 6 - Typical Transient Thermal Impedance

## PACKAGE OUTLINE DIMENSIONS in inches (millimeters)

### SMP (DO-220AA)





## Disclaimer

ALL PRODUCT, PRODUCT SPECIFICATIONS AND DATA ARE SUBJECT TO CHANGE WITHOUT NOTICE TO IMPROVE RELIABILITY, FUNCTION OR DESIGN OR OTHERWISE.

Vishay Intertechnology, Inc., its affiliates, agents, and employees, and all persons acting on its or their behalf (collectively, "Vishay"), disclaim any and all liability for any errors, inaccuracies or incompleteness contained in any datasheet or in any other disclosure relating to any product.

Vishay makes no warranty, representation or guarantee regarding the suitability of the products for any particular purpose or the continuing production of any product. To the maximum extent permitted by applicable law, Vishay disclaims (i) any and all liability arising out of the application or use of any product, (ii) any and all liability, including without limitation special, consequential or incidental damages, and (iii) any and all implied warranties, including warranties of fitness for particular purpose, non-infringement and merchantability.

Statements regarding the suitability of products for certain types of applications are based on Vishay's knowledge of typical requirements that are often placed on Vishay products in generic applications. Such statements are not binding statements about the suitability of products for a particular application. It is the customer's responsibility to validate that a particular product with the properties described in the product specification is suitable for use in a particular application. Parameters provided in datasheets and / or specifications may vary in different applications and performance may vary over time. All operating parameters, including typical parameters, must be validated for each customer application by the customer's technical experts. Product specifications do not expand or otherwise modify Vishay's terms and conditions of purchase, including but not limited to the warranty expressed therein.

Hyperlinks included in this datasheet may direct users to third-party websites. These links are provided as a convenience and for informational purposes only. Inclusion of these hyperlinks does not constitute an endorsement or an approval by Vishay of any of the products, services or opinions of the corporation, organization or individual associated with the third-party website. Vishay disclaims any and all liability and bears no responsibility for the accuracy, legality or content of the third-party website or for that of subsequent links.

Except as expressly indicated in writing, Vishay products are not designed for use in medical, life-saving, or life-sustaining applications or for any other application in which the failure of the Vishay product could result in personal injury or death. Customers using or selling Vishay products not expressly indicated for use in such applications do so at their own risk. Please contact authorized Vishay personnel to obtain written terms and conditions regarding products designed for such applications.

No license, express or implied, by estoppel or otherwise, to any intellectual property rights is granted by this document or by any conduct of Vishay. Product names and markings noted herein may be trademarks of their respective owners.

单击下面可查看定价，库存，交付和生命周期等信息

[>>Vishay\(威世\)](#)