

Small Signal Zener Diodes

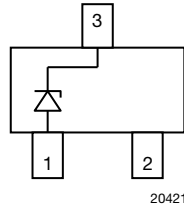

LINKS TO ADDITIONAL RESOURCES



MARKING (example only)

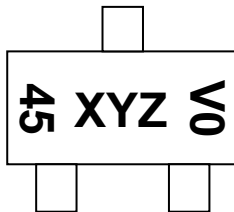

XYZ = type code
 45 = working week
 0 = year
 V = Vishay

FEATURES

- Silicon planar Zener diodes
- The Zener voltages are graded according to the international E24 standard. Standard Zener voltage tolerance is $\pm 5\%$, indicated by the "C" in the ordering code. Replace "C" with "B" for $\pm 2\%$ tolerance.
- AEC-Q101 qualified available
- ESD capability acc. to AEC-Q101:
 human body model: > 8 kV,
 machine model: > 800 V
- Base P/N-E3 - RoHS-compliant, commercial grade
- Base P/N-HE3_A - RoHS-compliant, AEC-Q101 qualified
- Material categorization: for definitions of compliance please see www.vishay.com/doc?99912



PRIMARY CHARACTERISTICS		
PARAMETER	VALUE	UNIT
V_Z range nom.	2.2 to 75	V
Test current I_{ZT}	2; 5	mA
V_Z specification	Pulse current	
Circuit configuration	Single	

ORDERING INFORMATION					
DEVICE NAME	ORDERING CODE	ZENER VOLTAGE TOLERANCE	AEC-Q101 QUALIFIED	TAPED UNITS PER REEL	MINIMUM ORDER QUANTITY
BZX84 series	BZX84C2V4-E3-08 to BZX84C75-E3-08	5 %	no	3000 (8 mm tape on 7" reel)	15 000
	BZX84B2V4-E3-08 to BZX84B75-E3-08	2 %	no		
	BZX84C2V4-HE3_A-08 to BZX84C75-HE3_A-08	5 %	yes		
	BZX84B2V4-HE3_A-08 to BZX84B75-HE3_A-08	2 %	yes		
	BZX84C2V4-E3-18 to BZX84C75-E3-18	5 %	no	10 000 (8 mm tape on 13" reel)	10 000
	BZX84B2V4-E3-18 to BZX84B75-E3-18	2 %	no		
	BZX84C2V4-HE3_A-18 to BZX84C75-HE3_A-18	5 %	yes		
	BZX84B2V4-HE3_A-18 to BZX84B75-HE3_A-18	2 %	yes		

PACKAGE				
PACKAGE NAME	WEIGHT	MOLDING COMPOUND FLAMMABILITY RATING	MOISTURE SENSITIVITY LEVEL	SOLDERING CONDITIONS
SOT-23	9.2 mg	UL 94 V-0	MSL level 1 (according J-STD-020)	Peak temperature max. 260 °C



ABSOLUTE MAXIMUM RATINGS					
PARAMETER	TEST CONDITION		SYMBOL	VALUE	UNIT
Power dissipation	R _{thJL} = 250 K/W		P _{tot}	500	mW
	On FR-4 board with recommended soldering footprint		P _{tot}	300	mW
Thermal resistance junction to lead			R _{thJL}	250	K/W
Thermal resistance junction to ambient	According to JEDEC® 51-3 on FR-4 board with recommended soldering footprint		R _{thJA}	420	K/W
Junction temperature			T _j	150	°C
Storage temperature range			T _{stg}	-65 to +150	°C
Operating temperature range			T _{op}	-55 to +150	°C

ELECTRICAL CHARACTERISTICS (T _{amb} = 25 °C, unless otherwise specified)												
PART NUMBER	MARKING CODE	ZENER VOLTAGE RANGE			TEST CURRENT		REVERSE LEAKAGE CURRENT		DYNAMIC RESISTANCE f = 1 kHz		TEMPERATURE COEFFICIENT	
		V _Z at I _{ZT1}			I _{ZT1}	I _{ZT2}	I _R at V _R		Z _Z at I _{ZT1}	Z _{ZK} at I _{ZT2}	α _{VZ} at I _{ZT1}	
		V			mA		μA	V	Ω		10 ⁻⁴ /°C	
		MIN.	NOM.	MAX.					MAX.	MAX.	MIN.	MAX.
BZX84C2V2	G49	2.09	2.2	2.31	5	1	100	1	120	600	-9	-4
BZX84C2V4	G50	2.28	2.4	2.52	5	1	50	1	100	600	-9	-4
BZX84C2V7	G51	2.57	2.7	2.84	5	1	20	1	100	600	-9	-4
BZX84C3V0	G52	2.85	3.0	3.15	5	1	10	1	95	600	-9	-3
BZX84C3V3	G53	3.14	3.3	3.47	5	1	5	1	95	600	-8	-3
BZX84C3V6	G54	3.42	3.6	3.78	5	1	5	1	90	600	-8	-3
BZX84C3V9	G55	3.71	3.9	4.10	5	1	3	1	90	600	-7	-3
BZX84C4V3	G56	4.09	4.3	4.52	5	1	3	1	90	600	-6	-1
BZX84C4V7	G57	4.47	4.7	4.94	5	1	3	2	80	500	-5	2
BZX84C5V1	G58	4.85	5.1	5.36	5	1	2	2	60	480	-3	4
BZX84C5V6	G59	5.32	5.6	5.88	5	1	1	2	40	400	-2	6
BZX84C6V2	G60	5.89	6.2	6.51	5	1	3	4	10	150	-1	7
BZX84C6V8	G61	6.46	6.8	7.14	5	1	2	4	15	80	2	7
BZX84C7V5	G62	7.13	7.5	7.88	5	1	1	5	15	80	3	7
BZX84C8V2	G63	7.79	8.2	8.61	5	1	0.7	5	15	80	4	7
BZX84C9V1	G64	8.65	9.1	9.56	5	1	0.5	6	15	100	5	8
BZX84C10	G65	9.50	10	10.50	5	1	0.2	7	20	150	5	8
BZX84C11	G66	10.45	11	11.55	5	1	0.1	8	20	150	5	9
BZX84C12	G67	11.40	12	12.60	5	1	0.1	8	25	150	6	9
BZX84C13	G68	12.40	13	13.65	5	1	0.1	8	30	170	7	9
BZX84C15	G69	14.25	15	15.60	5	1	0.05	10.5	30	200	7	9
BZX84C16	G70	15.30	16	16.80	5	1	0.05	11.2	40	200	8	9.5
BZX84C18	G71	17.10	18	18.90	5	1	0.05	12.6	45	225	8	9.5
BZX84C20	G72	19.00	20	21.00	5	1	0.05	14.0	55	225	8	10
BZX84C22	G73	20.90	22	23.10	5	1	0.05	15.4	55	250	8	10
BZX84C24	G74	22.80	24	25.20	5	1	0.05	16.8	70	250	8	10
BZX84C27	G75	25.65	27	28.35	2	0.5	0.05	18.9	80	300	8	10
BZX84C30	G76	28.50	30	31.50	2	0.5	0.05	21.0	80	300	8	10
BZX84C33	G77	31.35	33	34.65	2	0.5	0.05	23.1	80	325	8	10
BZX84C36	G78	34.20	36	37.80	2	0.5	0.05	25.2	90	350	8	10
BZX84C39	G79	37.05	39	40.95	2	0.5	0.05	27.3	130	350	10	12
BZX84C43	G80	40.85	43	45.15	2	0.5	0.05	30.1	150	375	10	12
BZX84C47	G81	44.65	47	49.35	2	0.5	0.05	32.9	170	375	10	12
BZX84C51	G82	48.45	51	53.55	2	0.5	0.05	35.7	180	400	10	12
BZX84C56	G83	53.20	56	58.80	2	0.5	0.05	39.2	200	425	9	11
BZX84C62	G84	58.90	62	65.10	2	0.5	0.05	43.4	215	450	9	12
BZX84C68	G85	64.60	68	71.40	2	0.5	0.05	47.6	240	475	10	12
BZX84C75	G86	71.25	75	78.75	2	0.5	0.05	52.5	255	500	10	12



ELECTRICAL CHARACTERISTICS (T _{amb} = 25 °C, unless otherwise specified)												
PART NUMBER	MARKING CODE	ZENER VOLTAGE RANGE			TEST CURRENT		REVERSE LEAKAGE CURRENT		DYNAMIC RESISTANCE f = 1 kHz		TEMPERATURE COEFFICIENT	
		V _Z at I _{ZT1}			I _{ZT1}	I _{ZT2}	I _R at V _R		Z _Z at I _{ZT1}	Z _{ZK} at I _{ZT2}	α _{VZ} at I _{ZT1}	
		V			mA		μA	V	Ω		10 ⁻⁴ /°C	
		MIN.	NOM.	MAX.					MAX.	MAX.	MIN.	MAX.
BZX84B2V2	H49	2.16	2.2	2.24	5	1	100	1	120	600	-9	-4
BZX84B2V4	H50	2.35	2.4	2.45	5	1	50	1	100	600	-9	-4
BZX84B2V7	H51	2.65	2.7	2.75	5	1	20	1	100	600	-9	-4
BZX84B3V0	H52	2.94	3.0	3.06	5	1	10	1	95	600	-9	-3
BZX84B3V3	H53	3.23	3.3	3.37	5	1	5	1	95	600	-8	-3
BZX84B3V6	H54	3.53	3.6	3.67	5	1	5	1	90	600	-8	-3
BZX84B3V9	H55	3.82	3.9	3.98	5	1	3	1	90	600	-7	-3
BZX84B4V3	H56	4.21	4.3	4.39	5	1	3	1	90	600	-6	-1
BZX84B4V7	H57	4.61	4.7	4.79	5	1	3	2	80	500	-5	2
BZX84B5V1	H58	5.00	5.1	5.20	5	1	2	2	60	480	-3	4
BZX84B5V6	H59	5.49	5.6	5.71	5	1	1	2	40	400	-2	6
BZX84B6V2	H60	6.08	6.2	6.32	5	1	3	4	10	150	-1	7
BZX84B6V8	H61	6.66	6.8	6.94	5	1	2	4	15	80	2	7
BZX84B7V5	H62	7.35	7.5	7.65	5	1	1	5	15	80	3	7
BZX84B8V2	H63	8.04	8.2	8.36	5	1	0.7	5	15	80	4	7
BZX84B9V1	H64	8.92	9.1	9.28	5	1	0.5	6	15	100	5	8
BZX84B10	H65	9.80	10	10.20	5	1	0.2	7	20	150	5	8
BZX84B11	H66	10.78	11	11.22	5	1	0.1	8	20	150	5	9
BZX84B12	H67	11.76	12	12.24	5	1	0.1	8	25	150	6	9
BZX84B13	H68	12.74	13	13.26	5	1	0.1	8	30	170	7	9
BZX84B15	H69	14.70	15	15.30	5	1	0.05	10.5	30	200	7	9
BZX84B16	H70	15.68	16	16.32	5	1	0.05	11.2	40	200	8	9.5
BZX84B18	H71	17.64	18	18.36	5	1	0.05	12.6	45	225	8	9.5
BZX84B20	H72	19.60	20	20.40	5	1	0.05	14	55	225	8	10
BZX84B22	H73	21.56	22	22.44	5	1	0.05	15.4	55	250	8	10
BZX84B24	H74	23.52	24	24.48	5	1	0.05	16.8	70	250	8	10
BZX84B27	H75	26.46	27	27.54	2	0.5	0.05	18.9	80	300	8	10
BZX84B30	H76	29.40	30	30.60	2	0.5	0.05	21	80	300	8	10
BZX84B33	H77	32.34	33	33.66	2	0.5	0.05	23.1	80	325	8	10
BZX84B36	H78	35.28	36	36.72	2	0.5	0.05	25.2	90	350	8	10
BZX84B39	H79	38.22	39	39.78	2	0.5	0.05	27.3	130	350	10	12
BZX84B43	H80	42.14	43	43.86	2	0.5	0.05	30.1	150	375	10	12
BZX84B47	H81	46.06	47	47.94	2	0.5	0.05	32.9	170	375	10	12
BZX84B51	H82	49.98	51	52.02	2	0.5	0.05	35.7	180	400	10	12
BZX84B56	H83	54.88	56	57.12	2	0.5	0.05	39.2	200	425	9	11
BZX84B62	H84	60.76	62	63.24	2	0.5	0.05	43.4	215	450	9	12
BZX84B68	H85	66.64	68	69.36	2	0.5	0.05	47.6	240	475	10	12
BZX84B75	H86	73.50	75	76.50	2	0.5	0.05	52.5	255	500	10	12



TYPICAL CHARACTERISTICS (T_{amb} = 25 °C, unless otherwise specified)

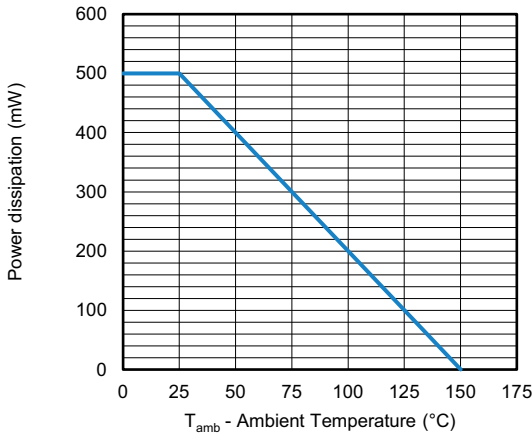

Fig. 1 - Admissible Power Dissipation vs. Ambient Temperature

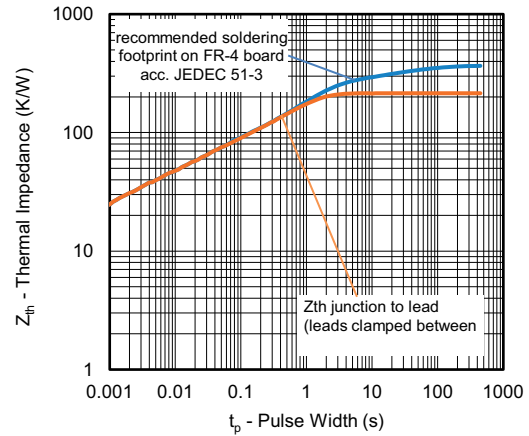
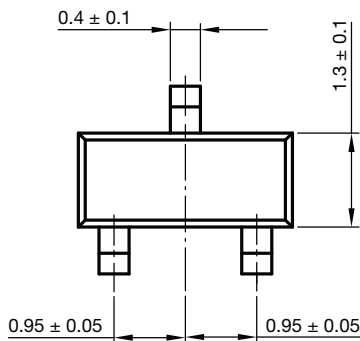
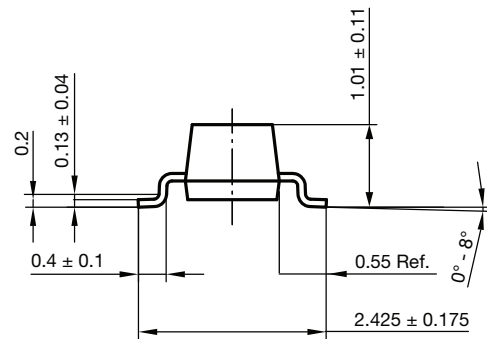
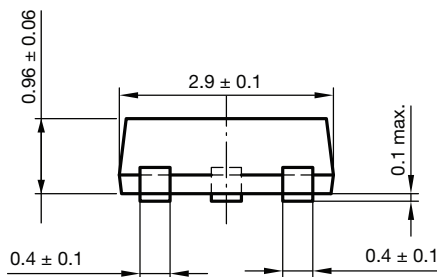
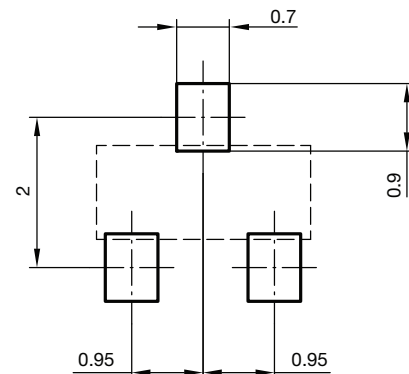

Fig. 2 - Thermal Impedance vs. Time

PACKAGE DIMENSIONS in millimeters (inches): SOT-23



Foot print recommendation:



Document no.: S8-V-3929.01-009 (4)
 Created - Date: 18. Oct. 2021
 Rev. 01 - Date: 18. Jan. 2022



ORIENTATION IN CARRIER TAPE



S8-V-3929.01-006 (4)
 Created Date: 04.02.2010
 Rev. 02 Date: 07.11.2022

CARRIER TAPE



B-B Section

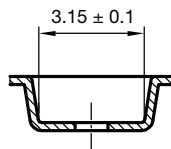

Document no.: S8-V-3929.01-005 (4)
 Created - Date: 04. Feb. 2010



Disclaimer

ALL PRODUCT, PRODUCT SPECIFICATIONS AND DATA ARE SUBJECT TO CHANGE WITHOUT NOTICE TO IMPROVE RELIABILITY, FUNCTION OR DESIGN OR OTHERWISE.

Vishay Intertechnology, Inc., its affiliates, agents, and employees, and all persons acting on its or their behalf (collectively, "Vishay"), disclaim any and all liability for any errors, inaccuracies or incompleteness contained in any datasheet or in any other disclosure relating to any product.

Vishay makes no warranty, representation or guarantee regarding the suitability of the products for any particular purpose or the continuing production of any product. To the maximum extent permitted by applicable law, Vishay disclaims (i) any and all liability arising out of the application or use of any product, (ii) any and all liability, including without limitation special, consequential or incidental damages, and (iii) any and all implied warranties, including warranties of fitness for particular purpose, non-infringement and merchantability.

Statements regarding the suitability of products for certain types of applications are based on Vishay's knowledge of typical requirements that are often placed on Vishay products in generic applications. Such statements are not binding statements about the suitability of products for a particular application. It is the customer's responsibility to validate that a particular product with the properties described in the product specification is suitable for use in a particular application. Parameters provided in datasheets and / or specifications may vary in different applications and performance may vary over time. All operating parameters, including typical parameters, must be validated for each customer application by the customer's technical experts. Product specifications do not expand or otherwise modify Vishay's terms and conditions of purchase, including but not limited to the warranty expressed therein.

Hyperlinks included in this datasheet may direct users to third-party websites. These links are provided as a convenience and for informational purposes only. Inclusion of these hyperlinks does not constitute an endorsement or an approval by Vishay of any of the products, services or opinions of the corporation, organization or individual associated with the third-party website. Vishay disclaims any and all liability and bears no responsibility for the accuracy, legality or content of the third-party website or for that of subsequent links.

Except as expressly indicated in writing, Vishay products are not designed for use in medical, life-saving, or life-sustaining applications or for any other application in which the failure of the Vishay product could result in personal injury or death. Customers using or selling Vishay products not expressly indicated for use in such applications do so at their own risk. Please contact authorized Vishay personnel to obtain written terms and conditions regarding products designed for such applications.

No license, express or implied, by estoppel or otherwise, to any intellectual property rights is granted by this document or by any conduct of Vishay. Product names and markings noted herein may be trademarks of their respective owners.

单击下面可查看定价，库存，交付和生命周期等信息

[>>Vishay\(威世\)](#)