

Fast Soft Recovery Rectifier Diode, 80 A

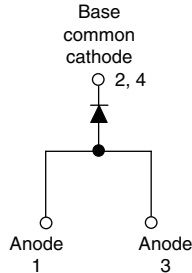

TO-247AC



FEATURES/DESCRIPTION

The 80EPF..PbF fast soft recovery rectifier series has been optimized for combined short reverse recovery time and low forward voltage drop.



RoHS* COMPLIANT

The glass passivation ensures stable reliable operation in the most severe temperature and power cycling conditions.

This product series has been designed and qualified for industrial level and lead (Pb)-free.

APPLICATIONS

- Output rectification and freewheeling in inverters, choppers and converters
- Input rectifications where severe restrictions on conducted EMI should be met

PRODUCT SUMMARY

V_F at 40 A	< 1.2 V
t_{rr}	90 ns
V_{RRM}	1000/1200 V

MAJOR RATINGS AND CHARACTERISTICS

SYMBOL	TEST CONDITIONS	VALUES	UNITS
V_{RRM}		1000/1200	V
$I_{F(AV)}$	Sinusoidal waveform	80	A
I_{FSM}		1100	
t_{rr}	1 A, - 100 A/ μ s	90	ns
V_F	40 A, $T_J = 25^\circ\text{C}$	1.2	V
T_J		- 40 to 150	$^\circ\text{C}$

VOLTAGE RATINGS

PART NUMBER	V_{RRM} , MAXIMUM PEAK REVERSE VOLTAGE V	V_{RSM} , MAXIMUM NON-REPETITIVE PEAK REVERSE VOLTAGE V	I_{RRM} AT 150 $^\circ\text{C}$ mA
80EPF10PbF	1000	1100	12
80EPF12PbF	1200	1300	

ABSOLUTE MAXIMUM RATINGS

PARAMETER	SYMBOL	TEST CONDITIONS	VALUES	UNITS
Maximum average forward current	$I_{F(AV)}$	$T_C = 92^\circ\text{C}$, 180 $^\circ$ conduction half sine wave	80	A
Maximum peak one cycle non-repetitive surge current	I_{FSM}	10 ms sine pulse, rated V_{RRM} applied	1100	
		10 ms sine pulse, no voltage reapplied	1250	
Maximum I^2t for fusing	I^2t	10 ms sine pulse, rated V_{RRM} applied	5000	A^2s
		10 ms sine pulse, no voltage reapplied	7000	
Maximum $I^2\sqrt{t}$ for fusing	$I^2\sqrt{t}$	$t = 0.1$ to 10 ms, no voltage reapplied	70 000	$\text{A}^2\sqrt{\text{s}}$

* Pb containing terminations are not RoHS compliant, exemptions may apply

80EPF..PbF Soft Recovery Series



Vishay High Power Products

Fast Soft Recovery
Rectifier Diode, 80 A

ELECTRICAL SPECIFICATIONS					
PARAMETER	SYMBOL	TEST CONDITIONS		VALUES	UNITS
Maximum forward voltage drop	V_{FM}	80 A, $T_J = 25\text{ }^\circ\text{C}$		1.35	V
Forward slope resistance	r_t	$T_J = 150\text{ }^\circ\text{C}$		4.03	$\text{m}\Omega$
Threshold voltage	$V_{F(TO)}$			0.87	V
Maximum reverse leakage current	I_{RM}	$T_J = 25\text{ }^\circ\text{C}$	$V_R = \text{Rated } V_{RRM}$	0.1	mA
		$T_J = 150\text{ }^\circ\text{C}$		12	

RECOVERY CHARACTERISTICS				
PARAMETER	SYMBOL	TEST CONDITIONS	VALUES	UNITS
Reverse recovery time	t_{rr}	I_F at 80 Apk 25 A/ μs 25 $^\circ\text{C}$	480	ns
Reverse recovery current	I_{rr}		7.1	A
Reverse recovery charge	Q_{rr}		2.1	μC
Snap factor	S		0.5	

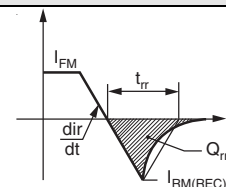

THERMAL - MECHANICAL SPECIFICATIONS				
PARAMETER	SYMBOL	TEST CONDITIONS	VALUES	UNITS
Maximum junction and storage temperature range	T_J, T_{Stg}		- 40 to 150	$^\circ\text{C}$
Maximum thermal resistance, junction to case	R_{thJC}	DC operation	0.35	$^\circ\text{C/W}$
Maximum thermal resistance, junction to ambient	R_{thJA}		40	
Typical thermal resistance, case to heatsink	R_{thCS}	Mounting surface, smooth and greased	0.2	
Approximate weight			6	g
			0.21	oz.
Mounting torque	minimum		6 (5)	kgf · cm (lbf · in)
	maximum		12 (10)	
Marking device		Case style TO-247AC (JEDEC)	80EPF10	
			80EPF12	

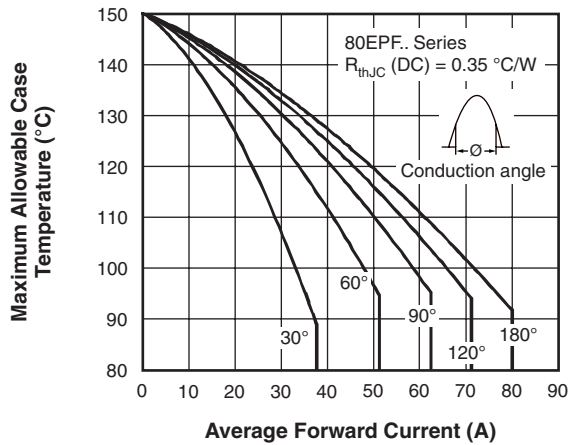

Fig. 1 - Current Rating Characteristics

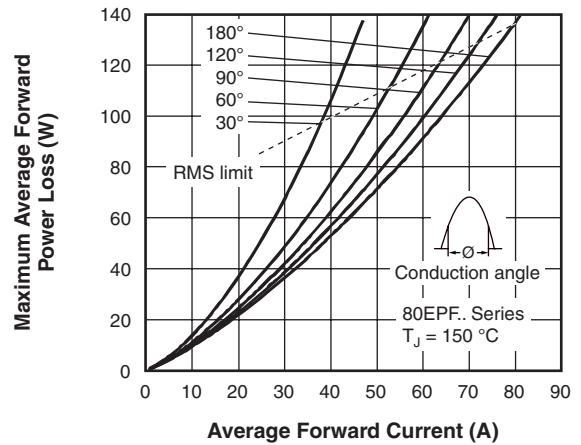

Fig. 4 - Forward Power Loss Characteristics

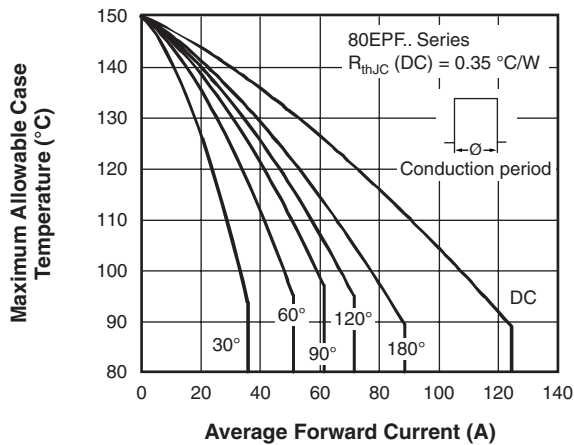

Fig. 2 - Current Rating Characteristics

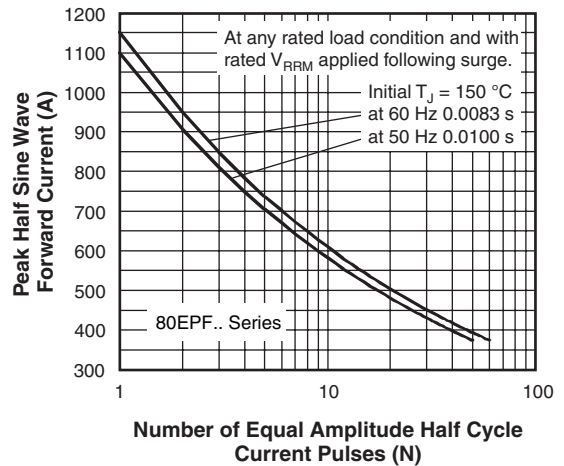

Fig. 5 - Maximum Non-Repetitive Surge Current

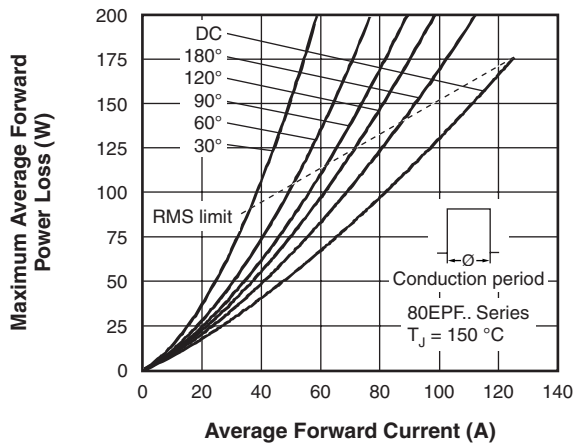

Fig. 3 - Forward Power Loss Characteristics

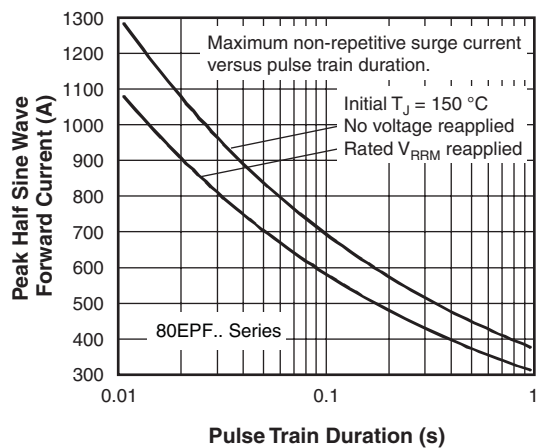

Fig. 6 - Maximum Non-Repetitive Surge Current

80EPF..PbF Soft Recovery Series



Vishay High Power Products

Fast Soft Recovery Rectifier Diode, 80 A

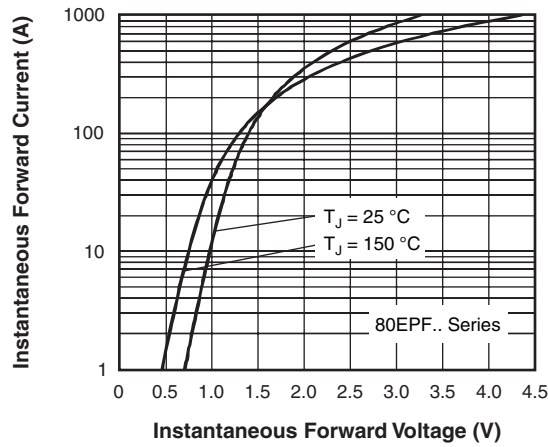

Fig. 7 - Forward Voltage Drop Characteristics

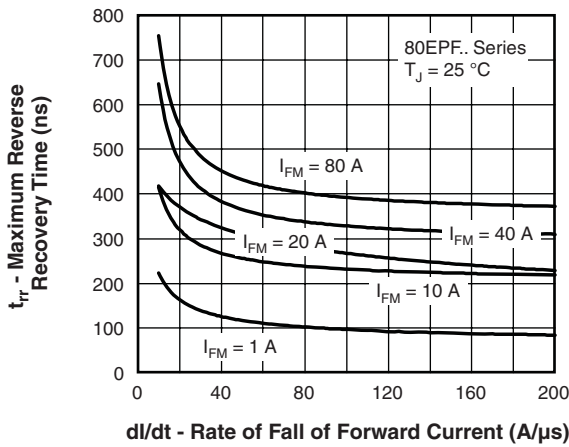

Fig. 8 - Recovery Time Characteristics, $T_J = 25\text{ °C}$

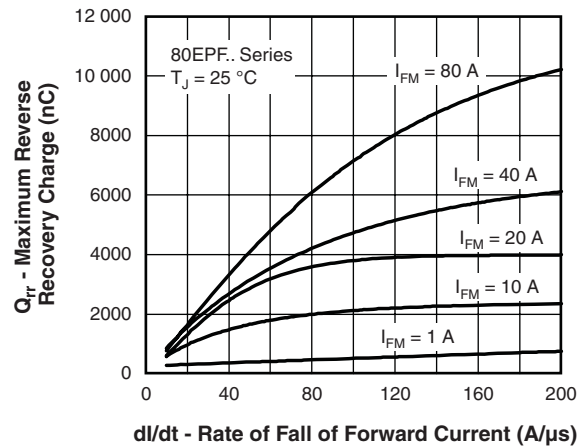

Fig. 10 - Recovery Charge Characteristics, $T_J = 25\text{ °C}$

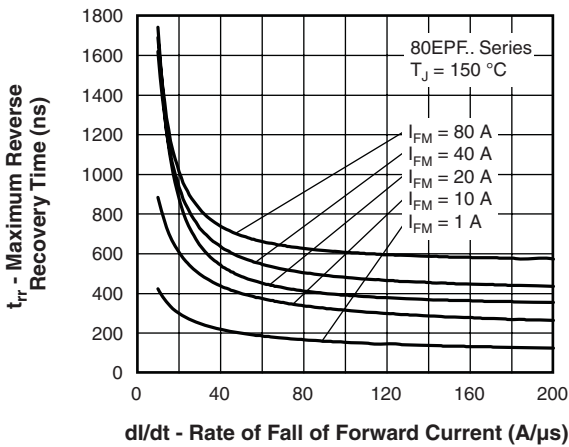

Fig. 9 - Recovery Time Characteristics, $T_J = 150\text{ °C}$

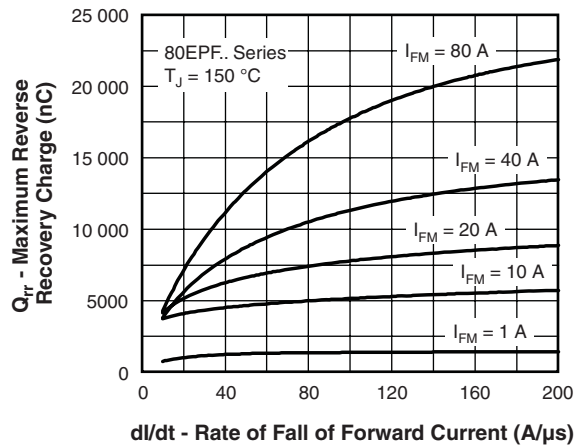

Fig. 11 - Recovery Charge Characteristics, $T_J = 150\text{ °C}$



80EPF..PbF Soft Recovery Series

Fast Soft Recovery
Rectifier Diode, 80 A

Vishay High Power Products

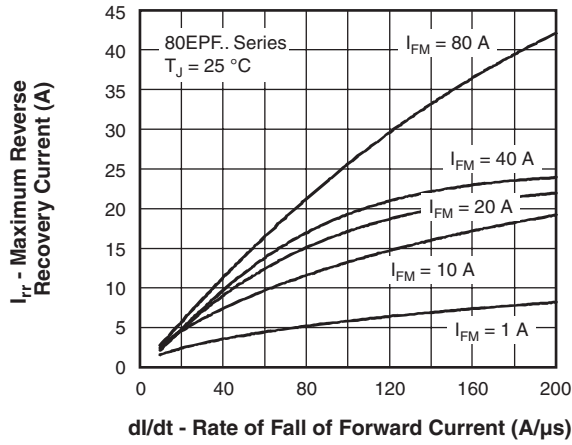

Fig. 12 - Recovery Current Characteristics, $T_J = 25\text{ }^\circ\text{C}$

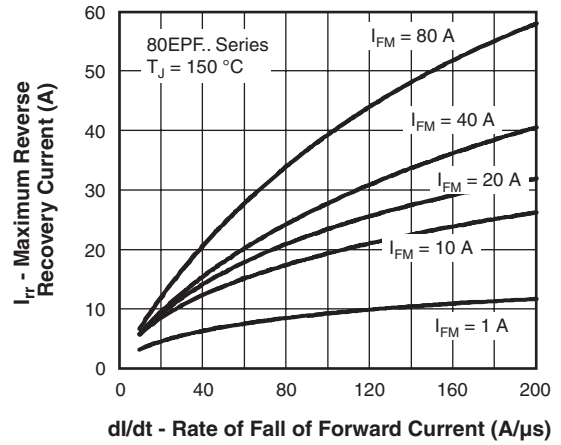

Fig. 13 - Recovery Current Characteristics, $T_J = 150\text{ }^\circ\text{C}$

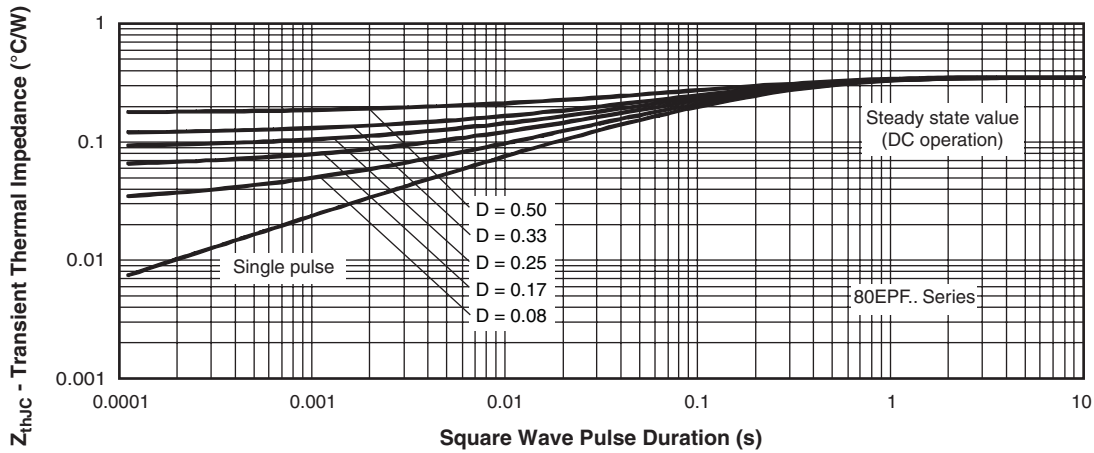

Fig. 14 - Thermal Impedance Z_{thJC} Characteristics

80EPF..PbF Soft Recovery Series



Vishay High Power Products

Fast Soft Recovery
Rectifier Diode, 80 A

ORDERING INFORMATION TABLE

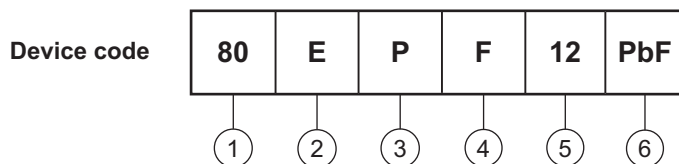

- 1** - Current rating (80 = 80 A)
- 2** - Circuit configuration:
E = Single diode
- 3** - Package:
P = TO-247AC
- 4** - Type of silicon:
F = Fast diode
- 5** - Voltage code x 100 = V_{RRM}
- 6** -
 - None = Standard production
 - PbF = Lead (Pb)-free

10 = 1000 V
12 = 1200 V

LINKS TO RELATED DOCUMENTS	
Dimensions	http://www.vishay.com/doc?95223
Part marking information	http://www.vishay.com/doc?95226



DIMENSIONS in millimeters and inches

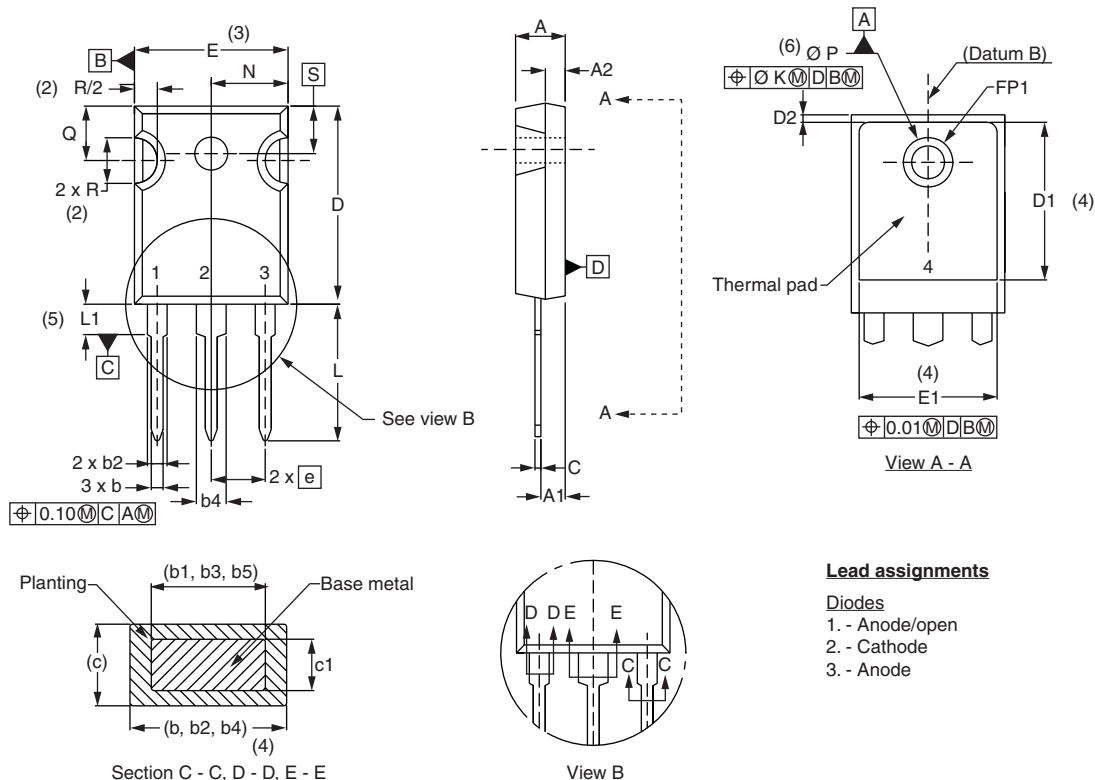

SYMBOL	MILLIMETERS		INCHES		NOTES	SYMBOL	MILLIMETERS		INCHES		NOTES
	MIN.	MAX.	MIN.	MAX.			MIN.	MAX.	MIN.	MAX.	
A	4.65	5.31	0.183	0.209		D2	0.51	1.30	0.020	0.051	
A1	2.21	2.59	0.087	0.102		E	15.29	15.87	0.602	0.625	3
A2	1.50	2.49	0.059	0.098		E1	13.72	-	0.540	-	
b	0.99	1.40	0.039	0.055		e	5.46 BSC		0.215 BSC		
b1	0.99	1.35	0.039	0.053		FK	2.54		0.010		
b2	1.65	2.39	0.065	0.094		L	14.20	16.10	0.559	0.634	
b3	1.65	2.37	0.065	0.094		L1	3.71	4.29	0.146	0.169	
b4	2.59	3.43	0.102	0.135		N	7.62 BSC		0.3		
b5	2.59	3.38	0.102	0.133		ΦP	3.56	3.66	0.14	0.144	
c	0.38	0.86	0.015	0.034		ΦP1	-	6.98	-	0.275	
c1	0.38	0.76	0.015	0.030		Q	5.31	5.69	0.209	0.224	
D	19.71	20.70	0.776	0.815	3	R	4.52	5.49	1.78	0.216	
D1	13.08	-	0.515	-	4	S	5.51 BSC		0.217 BSC		

Notes

- (1) Dimensioning and tolerancing per ASME Y14.5M-1994
- (2) Contour of slot optional
- (3) Dimension D and E do not include mold flash. Mold flash shall not exceed 0.127 mm (0.005") per side. These dimensions are measured at the outermost extremes of the plastic body
- (4) Thermal pad contour optional with dimensions D1 and E1
- (5) Lead finish uncontrolled in L1
- (6) Ø P to have a maximum draft angle of 1.5 to the top of the part with a maximum hole diameter of 3.91 mm (0.154")
- (7) Outline conforms to JEDEC outline TO-247 with exception of dimension c



Disclaimer

ALL PRODUCT, PRODUCT SPECIFICATIONS AND DATA ARE SUBJECT TO CHANGE WITHOUT NOTICE TO IMPROVE RELIABILITY, FUNCTION OR DESIGN OR OTHERWISE.

Vishay Intertechnology, Inc., its affiliates, agents, and employees, and all persons acting on its or their behalf (collectively, "Vishay"), disclaim any and all liability for any errors, inaccuracies or incompleteness contained in any datasheet or in any other disclosure relating to any product.

Vishay makes no warranty, representation or guarantee regarding the suitability of the products for any particular purpose or the continuing production of any product. To the maximum extent permitted by applicable law, Vishay disclaims (i) any and all liability arising out of the application or use of any product, (ii) any and all liability, including without limitation special, consequential or incidental damages, and (iii) any and all implied warranties, including warranties of fitness for particular purpose, non-infringement and merchantability.

Statements regarding the suitability of products for certain types of applications are based on Vishay's knowledge of typical requirements that are often placed on Vishay products in generic applications. Such statements are not binding statements about the suitability of products for a particular application. It is the customer's responsibility to validate that a particular product with the properties described in the product specification is suitable for use in a particular application. Parameters provided in datasheets and/or specifications may vary in different applications and performance may vary over time. All operating parameters, including typical parameters, must be validated for each customer application by the customer's technical experts. Product specifications do not expand or otherwise modify Vishay's terms and conditions of purchase, including but not limited to the warranty expressed therein.

Except as expressly indicated in writing, Vishay products are not designed for use in medical, life-saving, or life-sustaining applications or for any other application in which the failure of the Vishay product could result in personal injury or death. Customers using or selling Vishay products not expressly indicated for use in such applications do so at their own risk and agree to fully indemnify and hold Vishay and its distributors harmless from and against any and all claims, liabilities, expenses and damages arising or resulting in connection with such use or sale, including attorneys fees, even if such claim alleges that Vishay or its distributor was negligent regarding the design or manufacture of the part. Please contact authorized Vishay personnel to obtain written terms and conditions regarding products designed for such applications.

No license, express or implied, by estoppel or otherwise, to any intellectual property rights is granted by this document or by any conduct of Vishay. Product names and markings noted herein may be trademarks of their respective owners.

单击下面可查看定价，库存，交付和生命周期等信息

[>>Vishay\(威世\)](#)