

## TELUX LED

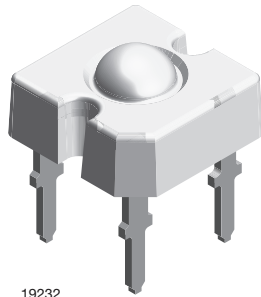

19232

### DESCRIPTION

The TELUX series is a clear, non-diffused LED for applications where supreme luminous flux is required.

It is designed in an industry standard 7.62 mm square package utilizing highly developed AlInGaP technology.

The supreme heat dissipation of TELUX allows applications at high ambient temperatures.

All packing units are binned for luminous flux, forward voltage, and color to achieve the most homogenous light appearance in application.

SAE and ECE color requirements for automobile application are available for color red.

### PRODUCT GROUP AND PACKAGE DATA

- Product group: LED
- Package: TELUX
- Product series: standard
- Angle of half intensity:  $\pm 30^\circ$

### FEATURES

- High luminous flux
- Supreme heat dissipation:  $R_{thJP}$  is 90 K/W
- High operating temperature:  
 $T_{amb} = -40\text{ }^\circ\text{C}$  to  $+110\text{ }^\circ\text{C}$
- Meets SAE and ECE color requirements for the automobile industry for color red
- Packed in tubes for automatic insertion
- Luminous flux, forward voltage, and color categorized for each tube
- Small mechanical tolerances allow precise usage of external reflectors or lightguides
- Compatible with wave solder processes according to CECC 00802 and J-STD-020
- ESD-withstand voltage: up to 2 kV according to JESD22-A114-B
- AEC-Q101 qualified
- Material categorization: for definitions of compliance please see [www.vishay.com/doc?99912](http://www.vishay.com/doc?99912)

AUTOMOTIVE GRADE

**RoHS**  
 COMPLIANT  
 HALOGEN  
**FREE**  
**GREEN**  
 (5-2008)

### APPLICATIONS

- Exterior lighting
- Dashboard illumination
- Tail-, stop-, and turn signals of motor vehicles
- Replaces small incandescent lamps
- Traffic signals and signs

### PARTS TABLE

PART	COLOR	LUMINOUS FLUX (mIm)			at $I_F$ (mA)	WAVELENGTH (nm)			at $I_F$ (mA)	FORWARD VOLTAGE (V)			at $I_F$ (mA)	TECHNOLOGY
		MIN.	TYP.	MAX.		MIN.	TYP.	MAX.		MIN.	TYP.	MAX.		
TLWR7600	Red	1500	2800	-	70	611	618	634	70	1.83	2.2	2.67	70	AllInGaP on GaAs
TLWY7600	Yellow	1000	2800	-	70	585	592	597	70	1.83	2.1	2.67	70	AllInGaP on GaAs

### ABSOLUTE MAXIMUM RATINGS ( $T_{amb} = 25\text{ }^\circ\text{C}$ , unless otherwise specified) TLWR7600, TLWY7600

PARAMETER	TEST CONDITION	SYMBOL	VALUE	UNIT
Reverse voltage <sup>(1)</sup>	$I_R = 100\text{ }\mu\text{A}$	$V_R$	10	V
DC forward current	$T_{amb} \leq 85\text{ }^\circ\text{C}$	$I_F$	70	mA
Surge forward current	$t_p \leq 10\text{ }\mu\text{s}$	$I_{FSM}$	1	A
Power dissipation		$P_V$	187	mW
Junction temperature		$T_j$	125	$^\circ\text{C}$
Operating temperature range		$T_{amb}$	-40 to +110	$^\circ\text{C}$
Storage temperature range		$T_{stg}$	-55 to +110	$^\circ\text{C}$
Soldering temperature	$t \leq 5\text{ s}$ , 1.5 mm from body preheat temperature $100\text{ }^\circ\text{C} / 30\text{ s}$	$T_{sd}$	260	$^\circ\text{C}$
Thermal resistance junction / ambient	With cathode heatsink of $70\text{ mm}^2$	$R_{thJA}$	200	K/W
Thermal resistance junction / pin		$R_{thJP}$	90	K/W

#### Note

<sup>(1)</sup> Driving the LED in reverse direction is suitable for a short term application



<b>OPTICAL AND ELECTRICAL CHARACTERISTICS</b> ( $T_{amb} = 25\text{ }^{\circ}\text{C}$ , unless otherwise specified) <b>TLWR7600, RED</b>						
PARAMETER	TEST CONDITION	SYMBOL	MIN.	TYP.	MAX.	UNIT
Total flux	$I_F = 70\text{ mA}$ , $R_{thJA} = 200\text{ K/W}$	$\phi_V$	1500	2800	-	mlm
Luminous intensity/total flux	$I_F = 70\text{ mA}$ , $R_{thJA} = 200\text{ K/W}$	$I_V/\phi_V$	-	0.8	-	mcd/mlm
Dominant wavelength	$I_F = 70\text{ mA}$ , $R_{thJA} = 200\text{ K/W}$	$\lambda_d$	611	618	634	nm
Peak wavelength	$I_F = 70\text{ mA}$ , $R_{thJA} = 200\text{ K/W}$	$\lambda_p$	-	626	-	nm
Angle of half intensity	$I_F = 70\text{ mA}$ , $R_{thJA} = 200\text{ K/W}$	$\phi$	-	$\pm 30$	-	deg
Total included angle	90 % of total flux captured	$\phi_{0.9V}$	-	75	-	deg
Forward voltage	$I_F = 70\text{ mA}$ , $R_{thJA} = 200\text{ K/W}$	$V_F$	1.83	2.2	2.67	V
Reverse voltage	$I_R = 10\text{ }\mu\text{A}$	$V_R$	10	20	-	V
Junction capacitance	$V_R = 0\text{ V}$ , $f = 1\text{ MHz}$	$C_j$	-	17	-	pF
Temperature coefficient of $\lambda_{dom}$	$I_F = 50\text{ mA}$	$T_C\lambda_{dom}$	-	0.05	-	nm/K

<b>OPTICAL AND ELECTRICAL CHARACTERISTICS</b> ( $T_{amb} = 25\text{ }^{\circ}\text{C}$ , unless otherwise specified) <b>TLWY7600, YELLOW</b>						
PARAMETER	TEST CONDITION	SYMBOL	MIN.	TYP.	MAX.	UNIT
Total flux	$I_F = 70\text{ mA}$ , $R_{thJA} = 200\text{ K/W}$	$\phi_V$	1000	2800	-	mlm
Luminous intensity/total flux	$I_F = 70\text{ mA}$ , $R_{thJA} = 200\text{ K/W}$	$I_V/\phi_V$	-	0.8	-	mcd/mlm
Dominant wavelength	$I_F = 70\text{ mA}$ , $R_{thJA} = 200\text{ K/W}$	$\lambda_d$	585	592	597	nm
Peak wavelength	$I_F = 70\text{ mA}$ , $R_{thJA} = 200\text{ K/W}$	$\lambda_p$	-	595	-	nm
Angle of half intensity	$I_F = 70\text{ mA}$ , $R_{thJA} = 200\text{ K/W}$	$\phi$	-	$\pm 30$	-	deg
Total included angle	90 % of total flux captured	$\phi_{0.9V}$	-	75	-	deg
Forward voltage	$I_F = 70\text{ mA}$ , $R_{thJA} = 200\text{ K/W}$	$V_F$	1.83	2.1	2.67	V
Reverse voltage	$I_R = 10\text{ }\mu\text{A}$	$V_R$	10	15	-	V
Junction capacitance	$V_R = 0\text{ V}$ , $f = 1\text{ MHz}$	$C_j$	-	32	-	pF
Temperature coefficient of $\lambda_{dom}$	$I_F = 50\text{ mA}$	$T_C\lambda_{dom}$	-	0.1	-	nm/K

<b>LUMINOUS FLUX CLASSIFICATION</b>		
GROUP	LUMINOUS FLUX (mlm)	
	MIN.	MAX.
STANDARD		
B	1000	1800
C	1500	2400
D	2000	3000
E	2500	3600
F	3000	4200
G	3500	4800
H	4000	6100
I	5000	7300

<b>COLOR CLASSIFICATION</b>				
GROUP	DOM. WAVELENGTH (nm)			
	YELLOW		RED	
	MIN.	MAX.	MIN.	MAX.
0	585	588		
1	587	591	611	618
2	589	594	614	622
3	592	597	616	634

**Note**

- Wavelengths are tested at a current pulse duration of 25 ms and an accuracy of  $\pm 1\text{ nm}$ .

**Note**

- Luminous flux is tested at a current pulse duration of 25 ms and an accuracy of  $\pm 11\%$ .  
The above type numbers represent the order groups which include only a few brightness groups. Only one group will be shipped on each tube (there will be no mixing of two groups on each tube).  
In order to ensure availability, single brightness groups will not be orderable.  
In a similar manner for colors where wavelength groups are measured and binned, single wavelength groups will be shipped in any one tube.  
In order to ensure availability, single wavelength groups will not be orderable.

FORWARD VOLTAGE CLASSIFICATION		
GROUP	FORWARD VOLTAGE (V)	
	MIN.	MAX.
Y	1.83	2.07
Z	1.95	2.19
0	2.07	2.31
1	2.19	2.43
2	2.31	2.55
3	2.43	2.67

**Note**

- Voltages are tested at a current pulse duration of 1 ms.

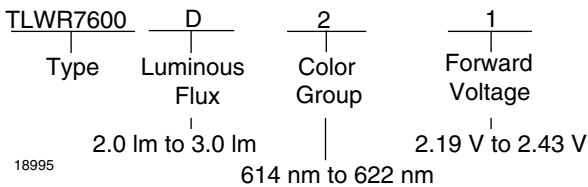

**TYPICAL CHARACTERISTICS** ( $T_{amb} = 25\text{ }^{\circ}\text{C}$ , unless otherwise specified)

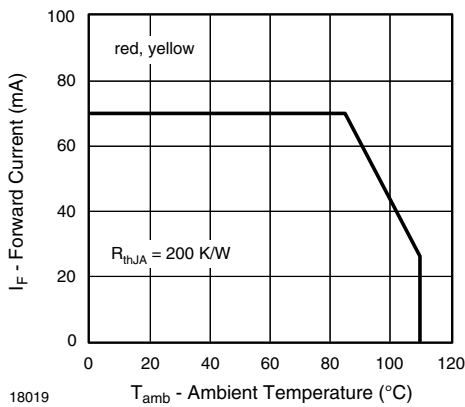

Fig. 1 - Forward Current vs. Ambient Temperature

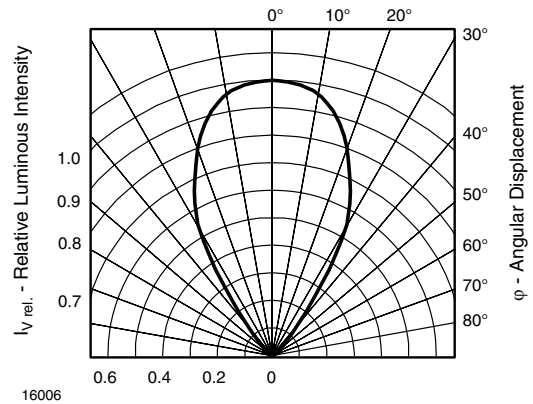

Fig. 3 - Relative Luminous Intensity vs. Angular Displacement

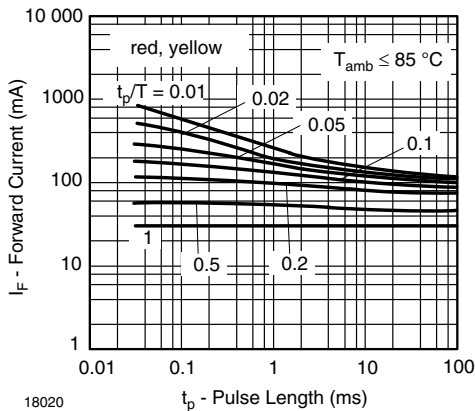

Fig. 2 - Forward Current vs. Pulse Length

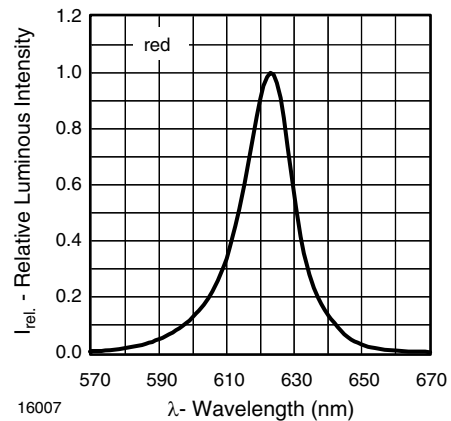

Fig. 4 - Relative Intensity vs. Wavelength

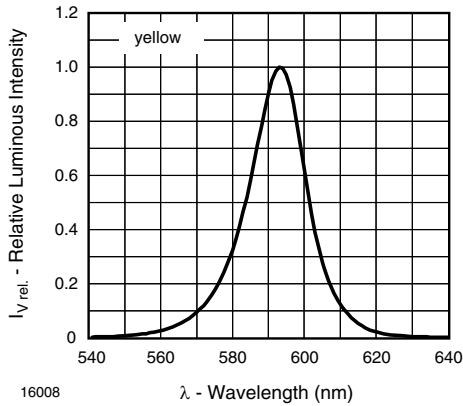

Fig. 5 - Relative Intensity vs. Wavelength

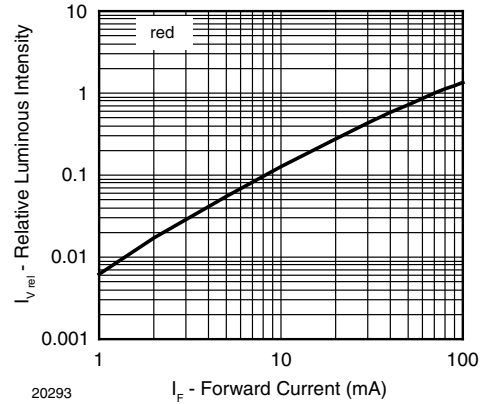

Fig. 8 - Relative Luminous Intensity vs. Forward Current

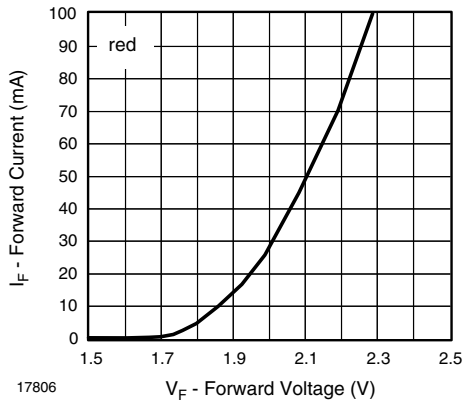

Fig. 6 - Forward Current vs. Forward Voltage

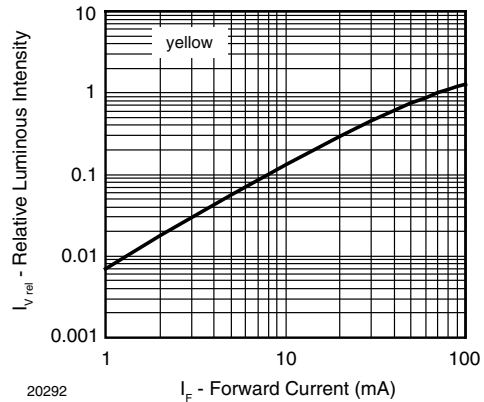

Fig. 9 - Relative Luminous Intensity vs. Forward Current



Fig. 7 - Forward Current vs. Forward Voltage

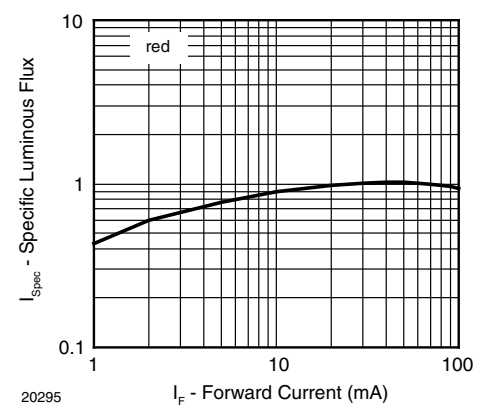

Fig. 10 - Specific Luminous Flux vs. Forward Current

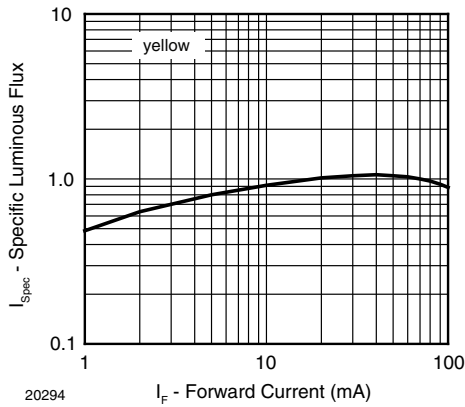

Fig. 11 - Specific Luminous Flux vs. Forward Current



Fig. 14 - Thermal Resistance Junction Ambient vs. Cathode Pads Size

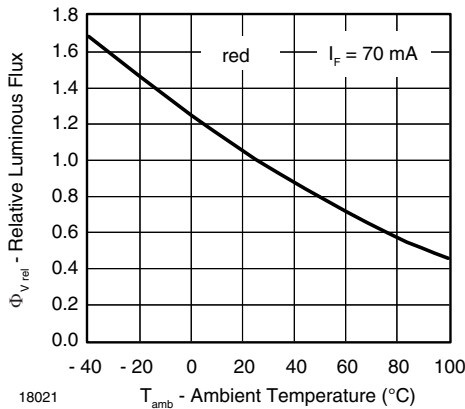

Fig. 12 - Relative Luminous Flux vs. Ambient Temperature

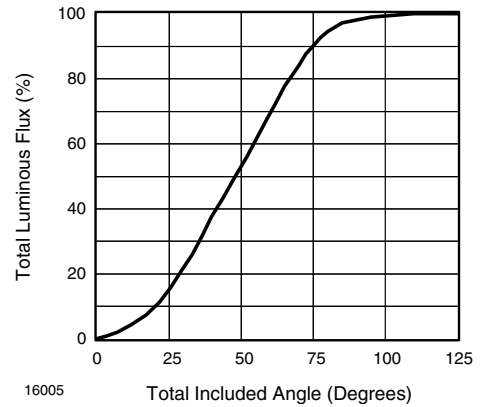

Fig. 15 - Percentage Total Luminous Flux vs. Total Included Angle for 90° Emission Angle

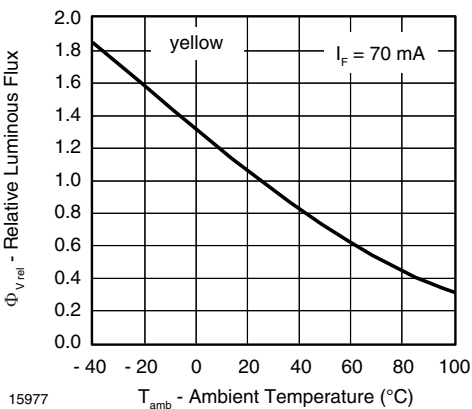
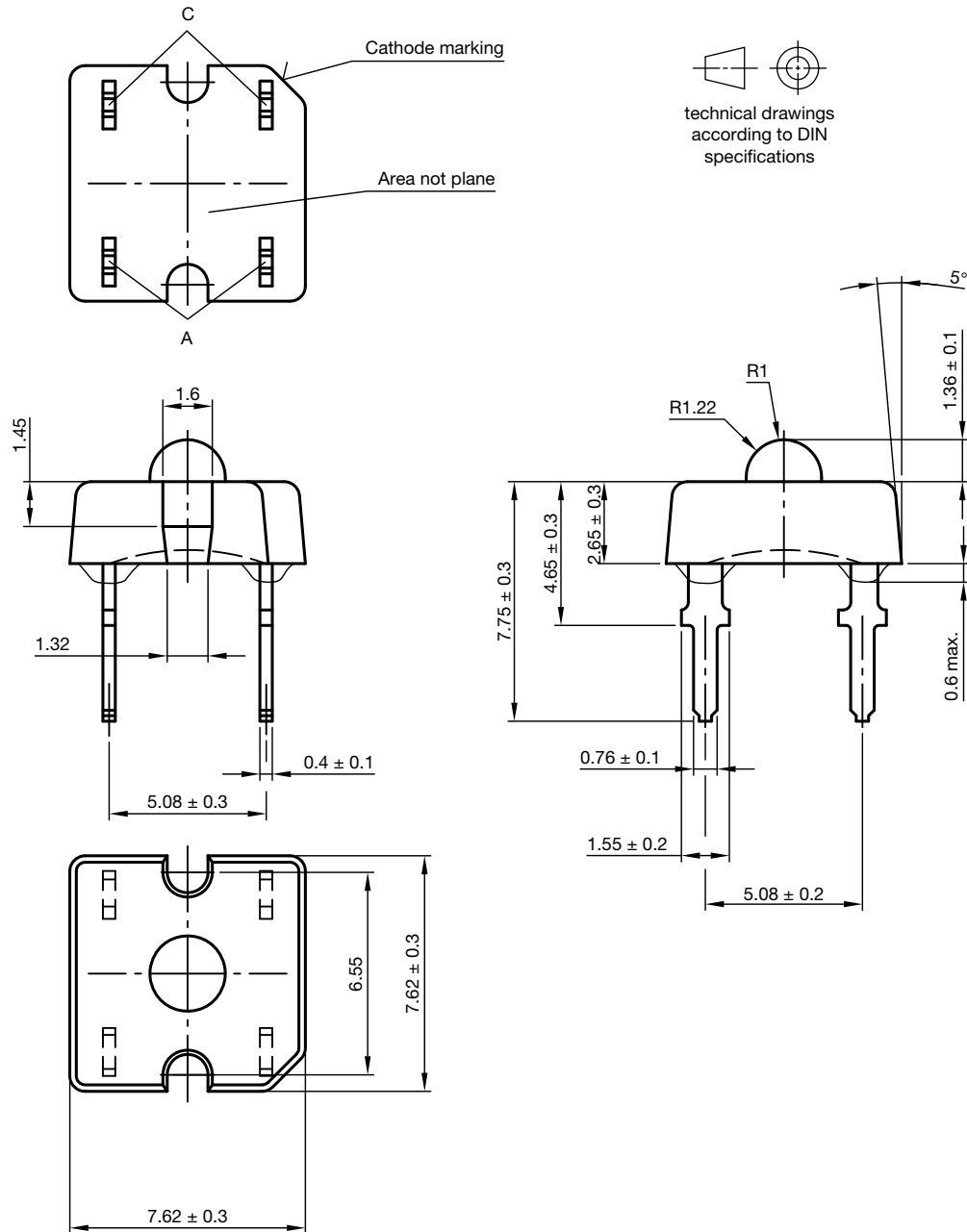

Fig. 13 - Relative Luminous Flux vs. Ambient Temperature



## PACKAGE DIMENSIONS in millimeters



Drawing-No.: 6.544-5321.02-4

Issue: 4; 25.07.14



FAN FOLD BOX DIMENSIONS in millimeters



LABEL OF FAN FOLD BOX (example)

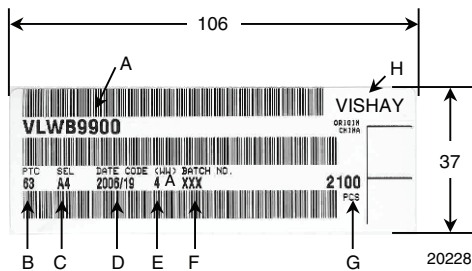

- A. Type of component
- B. Manufacturing plant
- C. SEL - selection code (bin):  
e.g.: A = code for luminous intensity group  
4 = code for color group
- D. Date code year / week
- E. Day code (e.g. 4: Thursday, A: early shift)
- F. Batch: no.
- G. Total quantity
- H. Company code

EXAMPLE FOR TELUX TUBE LABEL DIMENSIONS in millimeters

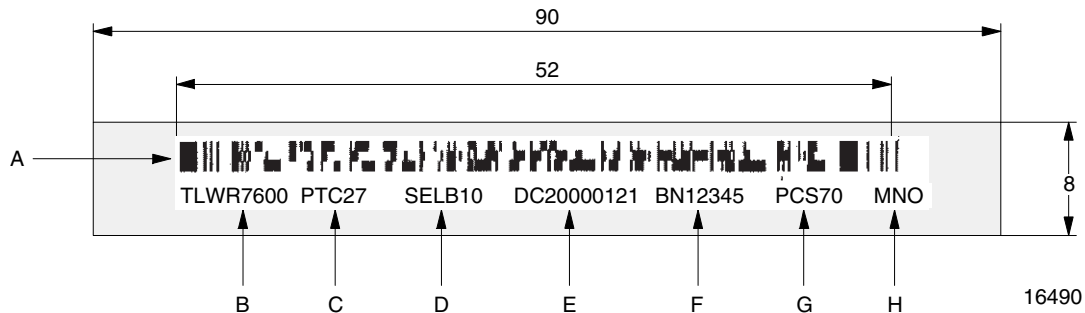

- A. Bar code
- B. Type of component
- C. Manufacturing plant
- D. SEL - selection code (bin):  
digit 1 - code for luminous flux group  
digit 2 - code for dominant wavelength group  
digit 3 - code for forward voltage group
- E. Date code
- F. Batch: no.
- G. Total quantity
- H. Company code

**TUBE WITH BAR CODE LABEL DIMENSIONS** in millimeters

"X"

90° gedreht / 90° turned



Wanddicke/wall thickness: 0.6±0.1  
 Geradheit/Straightness 2  
 Schnittwinkel/cut 90° ±1°

Geprüft nach/approved to: LV 5145

Bestücken mit 1 Stopper / equip with 1 stopper



Druck / Printing for tubes  
 1.400-5548.0-3 Version 1

Siebdruck von dieser Seite lesbar  
 Screen printing readable from this side

Drawing-No.: 9.700-5223.0-4

Rev. 2; Date: 23.08.99

20438

Drawing Proportions not Scaled





## Disclaimer

ALL PRODUCT, PRODUCT SPECIFICATIONS AND DATA ARE SUBJECT TO CHANGE WITHOUT NOTICE TO IMPROVE RELIABILITY, FUNCTION OR DESIGN OR OTHERWISE.

Vishay Intertechnology, Inc., its affiliates, agents, and employees, and all persons acting on its or their behalf (collectively, "Vishay"), disclaim any and all liability for any errors, inaccuracies or incompleteness contained in any datasheet or in any other disclosure relating to any product.

Vishay makes no warranty, representation or guarantee regarding the suitability of the products for any particular purpose or the continuing production of any product. To the maximum extent permitted by applicable law, Vishay disclaims (i) any and all liability arising out of the application or use of any product, (ii) any and all liability, including without limitation special, consequential or incidental damages, and (iii) any and all implied warranties, including warranties of fitness for particular purpose, non-infringement and merchantability.

Statements regarding the suitability of products for certain types of applications are based on Vishay's knowledge of typical requirements that are often placed on Vishay products in generic applications. Such statements are not binding statements about the suitability of products for a particular application. It is the customer's responsibility to validate that a particular product with the properties described in the product specification is suitable for use in a particular application. Parameters provided in datasheets and / or specifications may vary in different applications and performance may vary over time. All operating parameters, including typical parameters, must be validated for each customer application by the customer's technical experts. Product specifications do not expand or otherwise modify Vishay's terms and conditions of purchase, including but not limited to the warranty expressed therein.

Hyperlinks included in this datasheet may direct users to third-party websites. These links are provided as a convenience and for informational purposes only. Inclusion of these hyperlinks does not constitute an endorsement or an approval by Vishay of any of the products, services or opinions of the corporation, organization or individual associated with the third-party website. Vishay disclaims any and all liability and bears no responsibility for the accuracy, legality or content of the third-party website or for that of subsequent links.

Except as expressly indicated in writing, Vishay products are not designed for use in medical, life-saving, or life-sustaining applications or for any other application in which the failure of the Vishay product could result in personal injury or death. Customers using or selling Vishay products not expressly indicated for use in such applications do so at their own risk. Please contact authorized Vishay personnel to obtain written terms and conditions regarding products designed for such applications.

No license, express or implied, by estoppel or otherwise, to any intellectual property rights is granted by this document or by any conduct of Vishay. Product names and markings noted herein may be trademarks of their respective owners.

单击下面可查看定价，库存，交付和生命周期等信息

[>>Vishay\(威世\)](#)