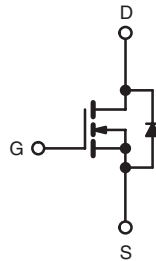
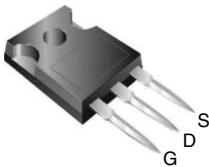

Power MOSFET

| PRODUCT SUMMARY | | |
|---------------------------|-----------------|------|
| V_{DS} (V) | 500 | |
| $R_{DS(on)}$ (Ω) | $V_{GS} = 10$ V | 0.24 |
| Q_g (Max.) (nC) | 124 | |
| Q_{gs} (nC) | 40 | |
| Q_{gd} (nC) | 57 | |
| Configuration | Single | |

TO-247

N-Channel MOSFET

FEATURES

- Low Gate Charge Q_g Results in Simple Drive Requirement
- Improved Gate, Avalanche and Dynamic dV/dt Ruggedness
- Fully Characterized Capacitance and Avalanche Voltage and Current
- Effective C_{OSS} Specified
- Lead (Pb)-free Available

RoHS*
COMPLIANT

APPLICATIONS

- Switch Mode Power Supply (SMPS)
- Uninterruptible Power Supply
- High Speed Power Switching

TYPICAL SMPS TOPOLOGIES

- Full Bridge
- Power Factor Correction Boost

| ORDERING INFORMATION | |
|----------------------|--------------|
| Package | TO-247 |
| Lead (Pb)-free | IRFP460NPbF |
| | SiHFP460N-E3 |
| SnPb | IRFP460N |
| | SiHFP460N |

| ABSOLUTE MAXIMUM RATINGS $T_C = 25^\circ\text{C}$, unless otherwise noted | | | | |
|--|--------------------------|---------------------------|---------------------|---|
| PARAMETER | SYMBOL | LIMIT | UNIT | |
| Drain-Source Voltage | V_{DS} | 500 | V | |
| Gate-Source Voltage | V_{GS} | ± 30 | | |
| Continuous Drain Current | V_{GS} at 10 V | $T_C = 25^\circ\text{C}$ | 20 | A |
| | | $T_C = 100^\circ\text{C}$ | 13 | |
| Pulsed Drain Current ^a | I_{DM} | 80 | | |
| Linear Derating Factor | | 2.2 | W/ $^\circ\text{C}$ | |
| Single Pulse Avalanche Energy ^b | E_{AS} | 340 | mJ | |
| Repetitive Avalanche Current ^a | I_{AR} | 20 | A | |
| Repetitive Avalanche Energy ^a | E_{AR} | 28 | mJ | |
| Maximum Power Dissipation | $T_C = 25^\circ\text{C}$ | P_D | 280 | W |
| Peak Diode Recovery dV/dt^c | dV/dt | 5.0 | V/ns | |
| Operating Junction and Storage Temperature Range | T_J, T_{stg} | - 55 to + 150 | $^\circ\text{C}$ | |
| Soldering Recommendations (Peak Temperature) | for 10 s | 300 ^d | | |
| Mounting Torque | 6-32 or M3 screw | 10 | lbf · in | |
| | | 1.1 | N · m | |

Notes

- Repetitive rating; pulse width limited by maximum junction temperature (see fig. 11).
- Starting $T_J = 25^\circ\text{C}$, $L = 1.8$ mH, $R_G = 25 \Omega$, $I_{AS} = 20$ A (see fig. 12).
- $I_{SD} \leq 20$ A, $dI/dt \leq 140$ A/ μs , $V_{DD} \leq V_{DS}$, $T_J \leq 150^\circ\text{C}$.
- 1.6 mm from case.

* Pb containing terminations are not RoHS compliant, exemptions may apply

| THERMAL RESISTANCE RATINGS | | | | |
|-------------------------------------|------------|------|------|------|
| PARAMETER | SYMBOL | TYP. | MAX. | UNIT |
| Maximum Junction-to-Ambient | R_{thJA} | - | 40 | °C/W |
| Case-to-Sink, Flat, Greased Surface | R_{thCS} | 0.24 | - | |
| Maximum Junction-to-Case (Drain) | R_{thJC} | - | 0.45 | |

| SPECIFICATIONS $T_J = 25\text{ }^\circ\text{C}$, unless otherwise noted | | | | | | | |
|--|-----------------------|--|---|------|-----------|---------------|----|
| PARAMETER | SYMBOL | TEST CONDITIONS | MIN. | TYP. | MAX. | UNIT | |
| Static | | | | | | | |
| Drain-Source Breakdown Voltage | V_{DS} | $V_{GS} = 0\text{ V}$, $I_D = 250\text{ }\mu\text{A}$ | 500 | - | - | V | |
| V_{DS} Temperature Coefficient | $\Delta V_{DS}/T_J$ | Reference to $25\text{ }^\circ\text{C}$, $I_D = 1\text{ mA}$ | - | 580 | - | mV/°C | |
| Gate-Source Threshold Voltage | $V_{GS(th)}$ | $V_{DS} = V_{GS}$, $I_D = 250\text{ }\mu\text{A}$ | 3.0 | - | 5.0 | V | |
| Gate-Source Leakage | I_{GSS} | $V_{GS} = \pm 30\text{ V}$ | - | - | ± 100 | nA | |
| Zero Gate Voltage Drain Current | I_{DSS} | $V_{DS} = 500\text{ V}$, $V_{GS} = 0\text{ V}$ | - | - | 25 | μA | |
| | | $V_{DS} = 400\text{ V}$, $V_{GS} = 0\text{ V}$, $T_J = 125\text{ }^\circ\text{C}$ | - | - | 250 | | |
| Drain-Source On-State Resistance | $R_{DS(on)}$ | $V_{GS} = 10\text{ V}$, $I_D = 12\text{ A}^b$ | - | - | 0.24 | Ω | |
| Forward Transconductance | g_{fs} | $V_{DS} = 50\text{ V}$, $I_D = 12\text{ A}$ | 10 | - | - | S | |
| Dynamic | | | | | | | |
| Input Capacitance | C_{iss} | $V_{GS} = 0\text{ V}$, $V_{DS} = 25\text{ V}$, $f = 1.0\text{ MHz}$, see fig. 5 | - | 3540 | - | pF | |
| Output Capacitance | C_{oss} | | - | 350 | - | | |
| Reverse Transfer Capacitance | C_{rss} | | - | 30 | - | | |
| Output Capacitance | C_{oss} | $V_{GS} = 0\text{ V}$ | $V_{DS} = 1.0\text{ V}$, $f = 1.0\text{ MHz}$ | - | 3930 | - | |
| Effective Output Capacitance | $C_{oss\text{ eff.}}$ | | $V_{DS} = 400\text{ V}$, $f = 1.0\text{ MHz}$ | - | 95 | - | |
| Total Gate Charge | Q_g | $V_{GS} = 10\text{ V}$ | $I_D = 20\text{ A}$, $V_{DS} = 400\text{ V}$ see fig. 6 and 13 ^b | - | - | 124 | nC |
| Gate-Source Charge | Q_{gs} | | | - | - | 40 | |
| Gate-Drain Charge | Q_{gd} | | | - | - | 57 | |
| Turn-On Delay Time | $t_{d(on)}$ | $V_{DD} = 250\text{ V}$, $I_D = 20\text{ A}$ $R_G = 4.3\text{ }\Omega$, $R_D = 13\text{ }\Omega$, see fig. 10 ^b | - | 23 | - | ns | |
| Rise Time | t_r | | - | 87 | - | | |
| Turn-Off Delay Time | $t_{d(off)}$ | | - | 34 | - | | |
| Fall Time | t_f | | - | 33 | - | | |
| Drain-Source Body Diode Characteristics | | | | | | | |
| Continuous Source-Drain Diode Current | I_S | MOSFET symbol showing the integral reverse p - n junction diode  | - | - | 20 | A | |
| Pulsed Diode Forward Current ^a | I_{SM} | | - | - | 80 | | |
| Body Diode Voltage | V_{SD} | $T_J = 25\text{ }^\circ\text{C}$, $I_S = 20\text{ A}$, $V_{GS} = 0\text{ V}^b$ | - | - | 1.8 | V | |
| Body Diode Reverse Recovery Time | t_{rr} | $T_J = 25\text{ }^\circ\text{C}$, $I_F = 20\text{ A}$, $dI/dt = 100\text{ A}/\mu\text{s}^b$ | - | 550 | 825 | ns | |
| Body Diode Reverse Recovery Charge | Q_{rr} | | - | 7.2 | 10.8 | μC | |
| Forward Turn-On Time | t_{on} | Intrinsic turn-on time is negligible (turn-on is dominated by L_S and L_D) | | | | | |

Notes

- a. Repetitive rating; pulse width limited by maximum junction temperature (see fig. 11).
- b. Pulse width $\leq 300\text{ }\mu\text{s}$; duty cycle $\leq 2\%$.
- c. $C_{oss\text{ eff.}}$ is a fixed capacitance that gives the same charging time as C_{oss} while V_{DS} is rising from 0 to 80 % V_{DS} .

TYPICAL CHARACTERISTICS 25 °C, unless otherwise noted

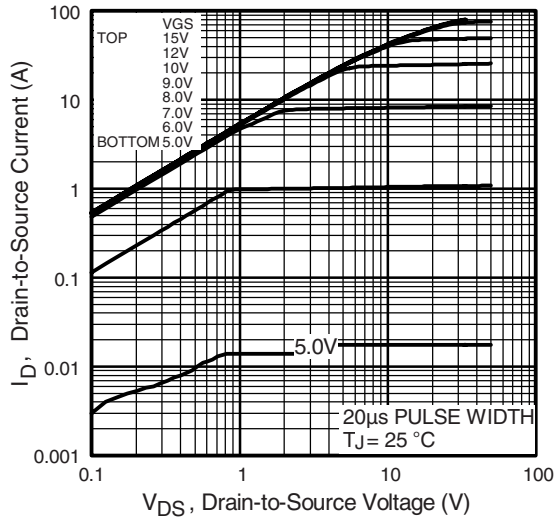

Fig. 1 - Typical Output Characteristics

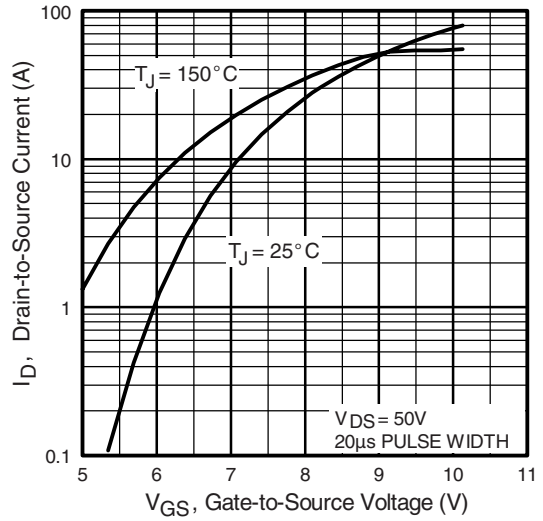

Fig. 3 - Typical Transfer Characteristics

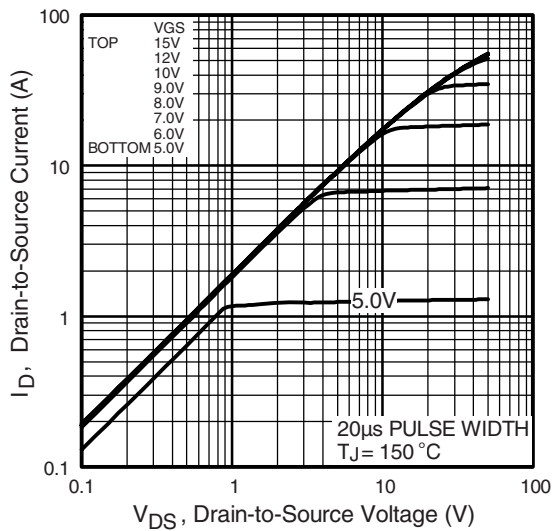

Fig. 2 - Typical Output Characteristics

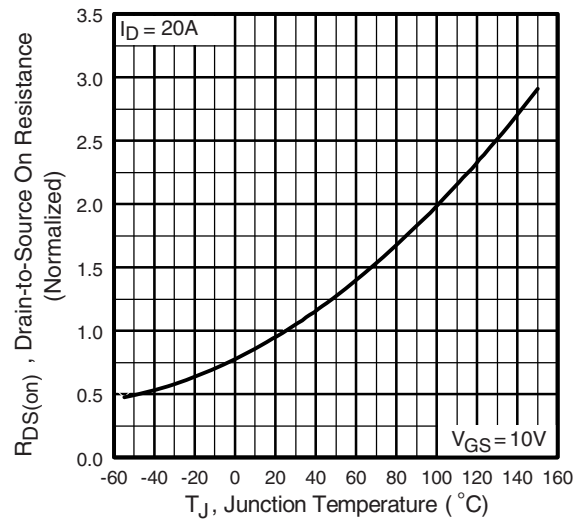

Fig. 4 - Normalized On-Resistance vs. Temperature

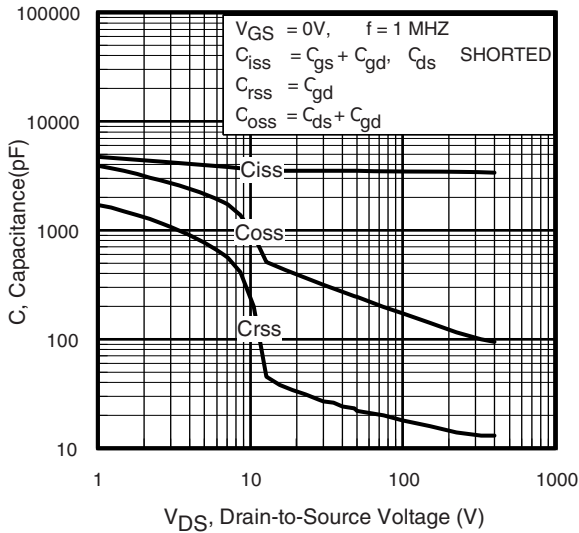

Fig. 5 - Typical Capacitance vs. Drain-to-Source Voltage

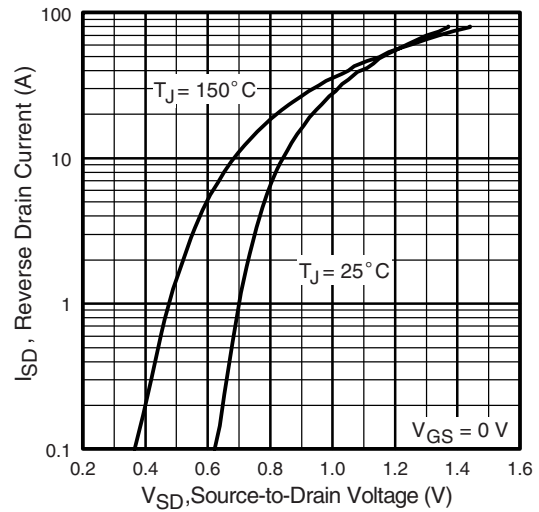

Fig. 7 - Typical Source-Drain Diode Forward Voltage

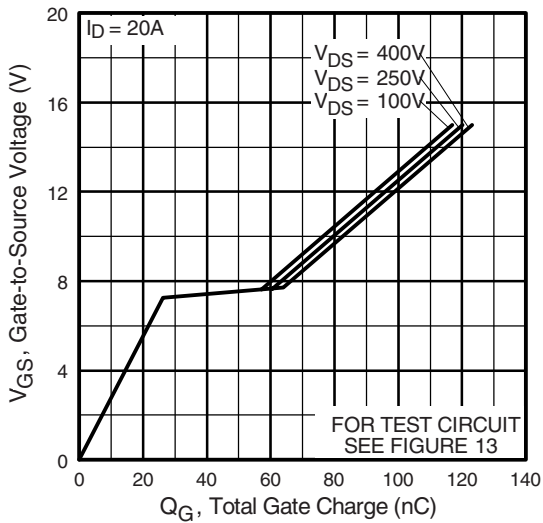

Fig. 6 - Typical Gate Charge vs. Gate-to-Source Voltage

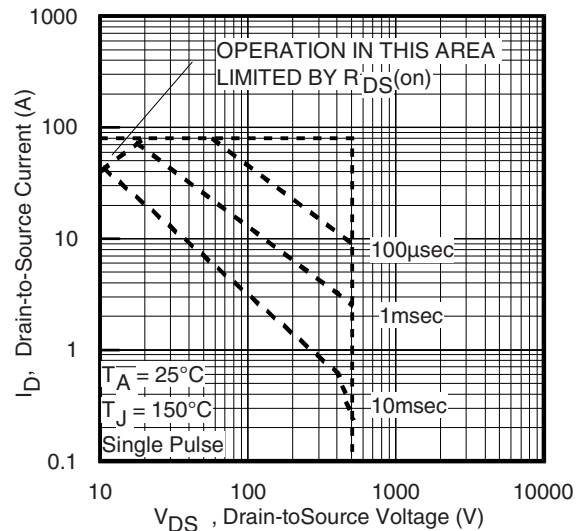

Fig. 8 - Maximum Safe Operating Area

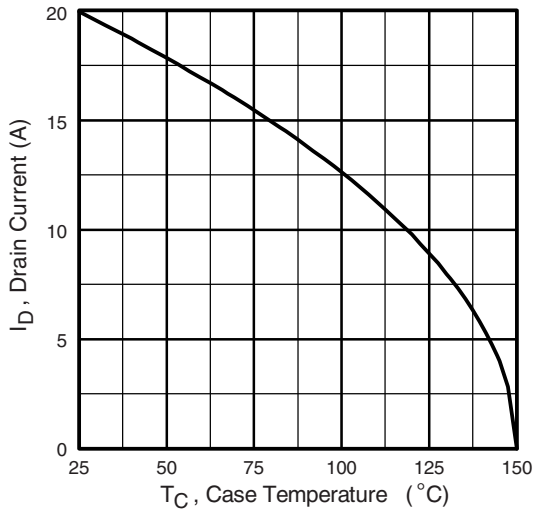

Fig. 9 - Maximum Drain Current vs. Case Temperature

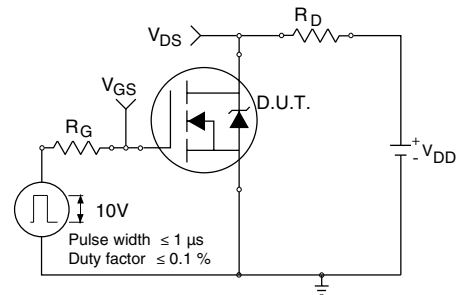

Fig. 10a - Switching Time Test Circuit

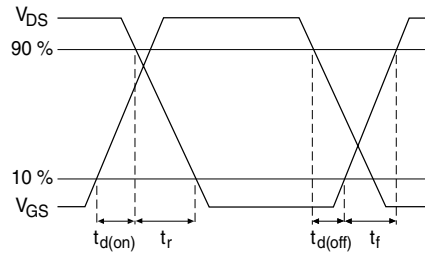

Fig. 10b - Switching Time Waveforms

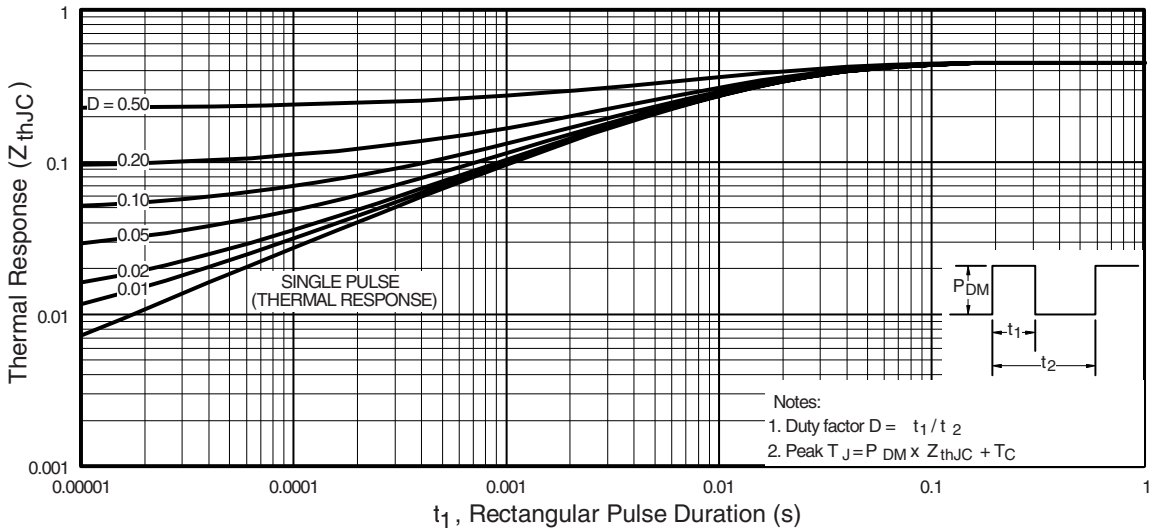

Fig. 11 - Maximum Effective Transient Thermal Impedance, Junction-to-Case

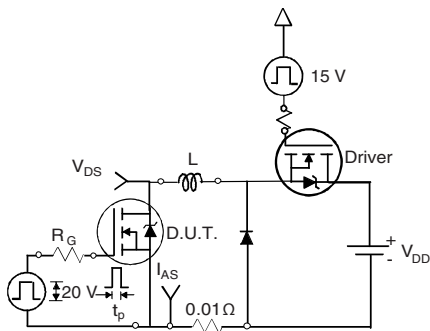

Fig. 12a - Unclamped Inductive Test Circuit

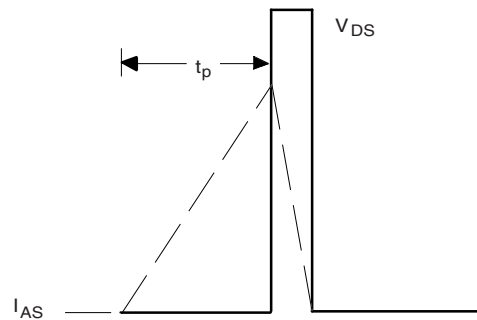

Fig. 12b - Unclamped Inductive Waveforms

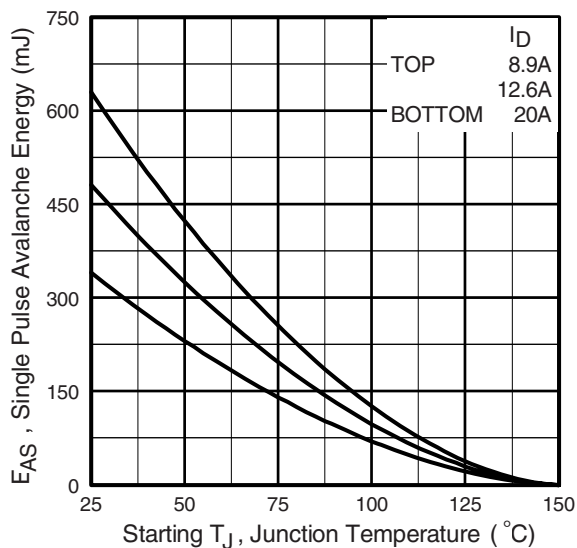

Fig. 12c - Maximum Avalanche Energy vs. Drain Current

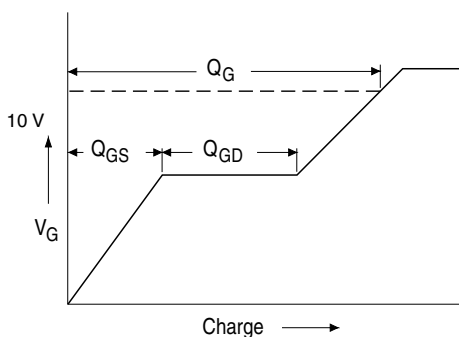

Fig. 13a - Basic Gate Charge Waveform

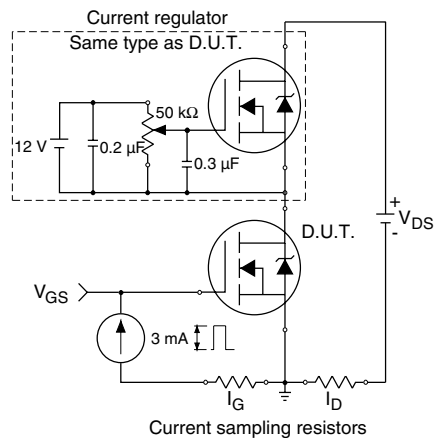
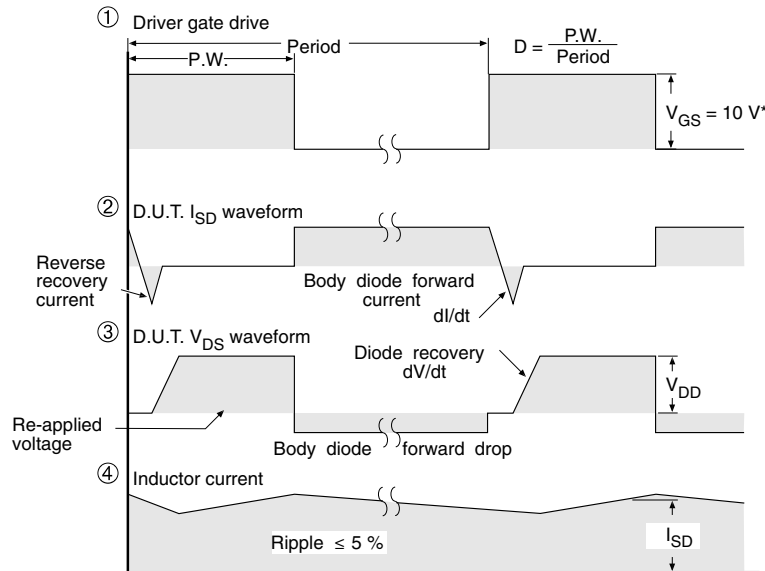
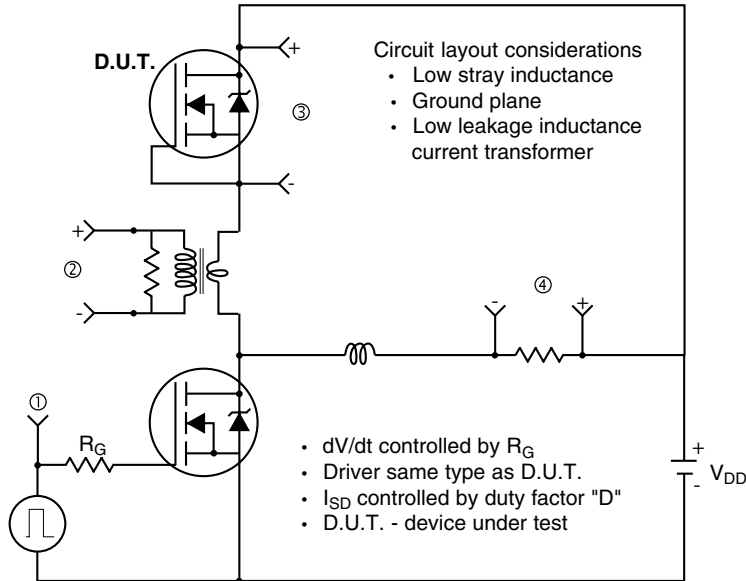

Fig. 13b - Gate Charge Test Circuit

Peak Diode Recovery dV/dt Test Circuit



* $V_{GS} = 5 V$ for logic level devices

Fig. 14 - For N-Channel

Vishay Siliconix maintains worldwide manufacturing capability. Products may be manufactured at one of several qualified locations. Reliability data for Silicon Technology and Package Reliability represent a composite of all qualified locations. For related documents such as package/tape drawings, part marking, and reliability data, see www.vishay.com/ppg?91236



Disclaimer

All product specifications and data are subject to change without notice.

Vishay Intertechnology, Inc., its affiliates, agents, and employees, and all persons acting on its or their behalf (collectively, "Vishay"), disclaim any and all liability for any errors, inaccuracies or incompleteness contained herein or in any other disclosure relating to any product.

Vishay disclaims any and all liability arising out of the use or application of any product described herein or of any information provided herein to the maximum extent permitted by law. The product specifications do not expand or otherwise modify Vishay's terms and conditions of purchase, including but not limited to the warranty expressed therein, which apply to these products.

No license, express or implied, by estoppel or otherwise, to any intellectual property rights is granted by this document or by any conduct of Vishay.

The products shown herein are not designed for use in medical, life-saving, or life-sustaining applications unless otherwise expressly indicated. Customers using or selling Vishay products not expressly indicated for use in such applications do so entirely at their own risk and agree to fully indemnify Vishay for any damages arising or resulting from such use or sale. Please contact authorized Vishay personnel to obtain written terms and conditions regarding products designed for such applications.

Product names and markings noted herein may be trademarks of their respective owners.

单击下面可查看定价，库存，交付和生命周期等信息

[>>Vishay\(威世\)](#)