

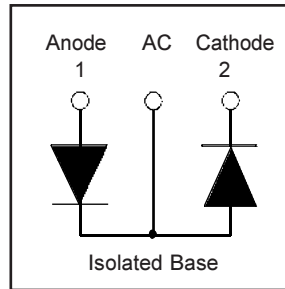
# HFA140MD60D

HEXFRED™

Ultrafast, Soft Recovery Diode

## Features

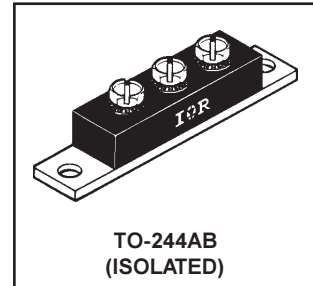
- Reduced RFI and EMI
- Reduced Snubbing
- Extensive Characterization of Recovery Parameters



$V_R = 600V$
$V_F(\text{typ.})^{\textcircled{2}} = 1.2V$
$I_{F(AV)} = 140A$
$Q_{rr}(\text{typ.}) = 360nC$
$I_{RRM}(\text{typ.}) = 8.0A$
$t_{rr}(\text{typ.}) = 35ns$
$di_{(rec)}/dt(\text{typ.})^{\textcircled{2}} = 230A/\mu s$

## Description

HEXFRED™ diodes are optimized to reduce losses and EMI/RFI in high frequency power conditioning systems. An extensive characterization of the recovery behavior for different values of current, temperature and di/dt simplifies the calculations of losses in the operating conditions. The softness of the recovery eliminates the need for a snubber in most applications. These devices are ideally suited for power converters, motors drives and other applications where switching losses are significant portion of the total losses.



## Absolute Maximum Ratings (per Leg)

	Parameter	Max.	Units
$V_R$	Cathode-to-Anode Voltage	600	V
$I_F @ T_C = 25^\circ C$	Continuous Forward Current	99	A
$I_F @ T_C = 100^\circ C$	Continuous Forward Current	48	
$I_{FSM}$	Single Pulse Forward Current <sup>①</sup>	600	
$P_D @ T_C = 25^\circ C$	Maximum Power Dissipation	227	W
$P_D @ T_C = 100^\circ C$	Maximum Power Dissipation	91	
$T_J$ $T_{STG}$	Operating Junction and Storage Temperature Range	-55 to +150	C

## Thermal - Mechanical Characteristics

	Parameter	Min.	Typ.	Max.	Units
$R_{thJC}$	Junction-to-Case, Single Leg Conducting	—	—	0.55	°C/W K/W
	Junction-to-Case, Both Legs Conducting	—	—	0.275	
$R_{thCS}$	Case-to-Sink, Flat , Greased Surface	—	0.10	—	
$Wt$	Weight	—	79 (2.8)	—	g (oz)
	Mounting Torque <sup>③</sup>	30 (3.4)	—	40 (4.6)	lbf•in (N•m)
	Terminal Torque	30 (3.4)	—	40 (4.6)	
	Vertical Pull	—	—	80	lbf•in
	2 inch Lever Pull	—	—	35	

Note: <sup>①</sup> Limited by junction temperature  
<sup>②</sup> 125°C

<sup>③</sup> Mounting surface must be smooth, flat, free or burrs or other protrusions. Apply a thin even film or thermal grease to mounting surface. Gradually tighten each mounting bolt in 5-10 lbf•in steps until desired or maximum torque limits are reached. Module

# HFA140MD60D

PD-40010 01/99

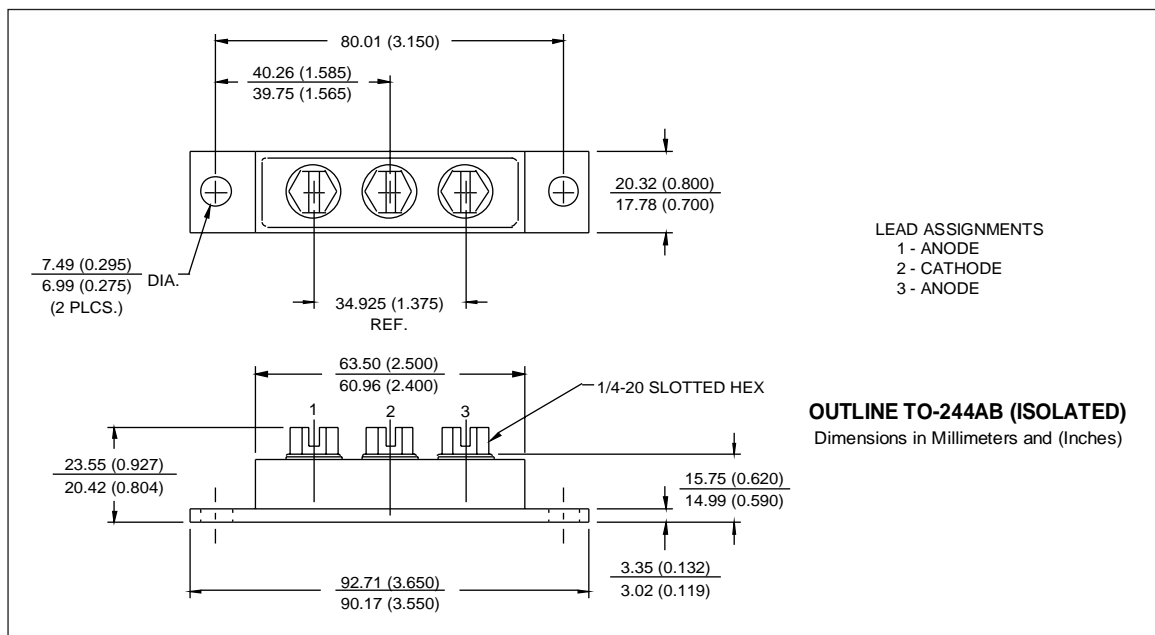
International  
**IOR** Rectifier

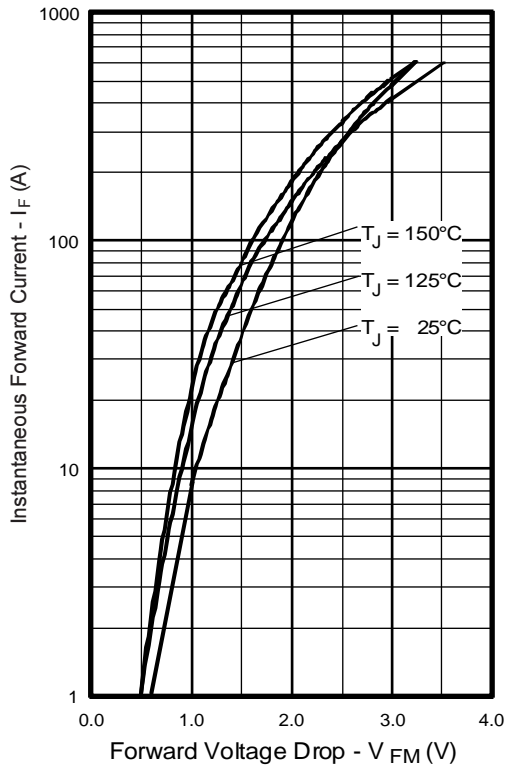
## Electrical Characteristics (per Leg) @ $T_J = 25^\circ\text{C}$ (unless otherwise specified)

	Parameter	Min.	Typ.	Max.	Units	Test Conditions
$V_{BR}$	Cathode Anode Breakdown Voltage	600	—	—	V	$I_R = 100\mu\text{A}$
$V_{FM}$	Max Forward Voltage	—	1.3	1.7	V	$I_F = 70\text{A}$ $I_F = 140\text{A}$ $I_F = 70\text{A}, T_J = 125^\circ\text{C}$ See Fig. 1
		—	1.5	2.0		
		—	1.2	1.5		
$I_{RM}$	Max Reverse Leakage Current	—	3.9	15	$\mu\text{A}$	$V_R = V_R$ Rated $T_J = 125^\circ\text{C}, V_R = 480\text{V}$ See Fig. 2
		—	1300	4300		
$C_T$	Junction Capacitance	—	200	300	pF	$V_R = 200\text{V}$ See Fig. 3
$L_S$	Series Inductance	—	6.0	—	nH	From top of terminal hole to mounting plane

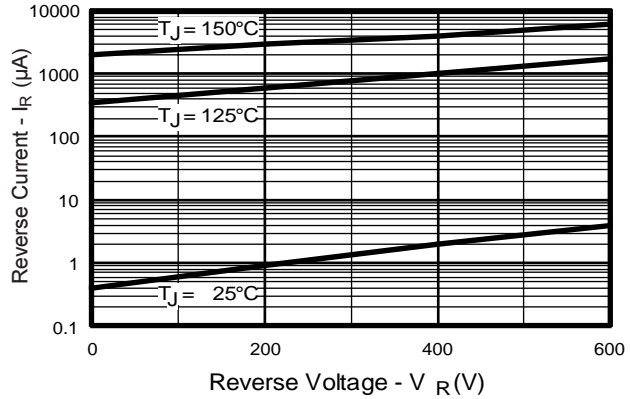
## Dynamic Recovery Characteristics (per Leg) @ $T_J = 25^\circ\text{C}$ (unless otherwise specified)

	Parameter	Min.	Typ.	Max.	Units	Test Conditions
$t_{rr}$	Reverse Recovery Time	—	35	—	ns	$I_F = 1.0\text{A}, di_F/dt = 200\text{A}/\mu\text{s}, V_R = 30\text{V}$ $T_J = 25^\circ\text{C}$ $T_J = 125^\circ\text{C}$ $I_F = 70\text{A}$ $V_R = 200\text{V}$ $di_F/dt = 200\text{A}/\mu\text{s}$
$t_{rr1}$	See Fig. 5, 10	—	90	140		
$t_{rr2}$		—	155	230		
$I_{RRM1}$	Peak Recovery Current	—	8.0	15	A	$T_J = 25^\circ\text{C}$ $T_J = 125^\circ\text{C}$ $V_R = 200\text{V}$
$I_{RRM2}$	See Fig. 6	—	14	25		
$Q_{rr1}$	Reverse Recovery Charge	—	360	1100	nC	$T_J = 25^\circ\text{C}$ $T_J = 125^\circ\text{C}$ $di_F/dt = 200\text{A}/\mu\text{s}$
$Q_{rr2}$	See Fig. 7	—	1100	2900		
$di_{(rec)M}/dt1$	Peak Rate of Fall of Recovery Current	—	300	—	A/ $\mu\text{s}$	$T_J = 25^\circ\text{C}$ $T_J = 125^\circ\text{C}$
$di_{(rec)M}/dt2$	During $t_b$ See Fig. 8	—	230	—		

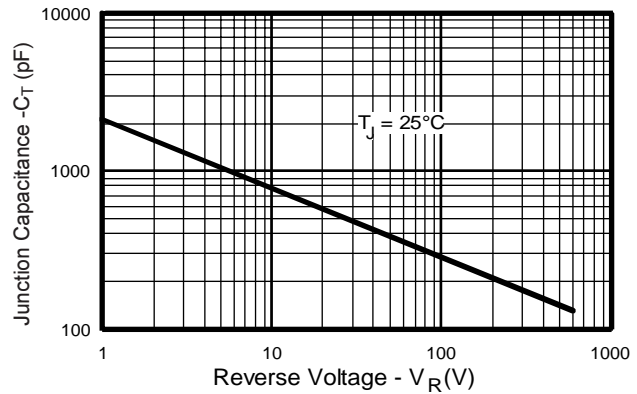




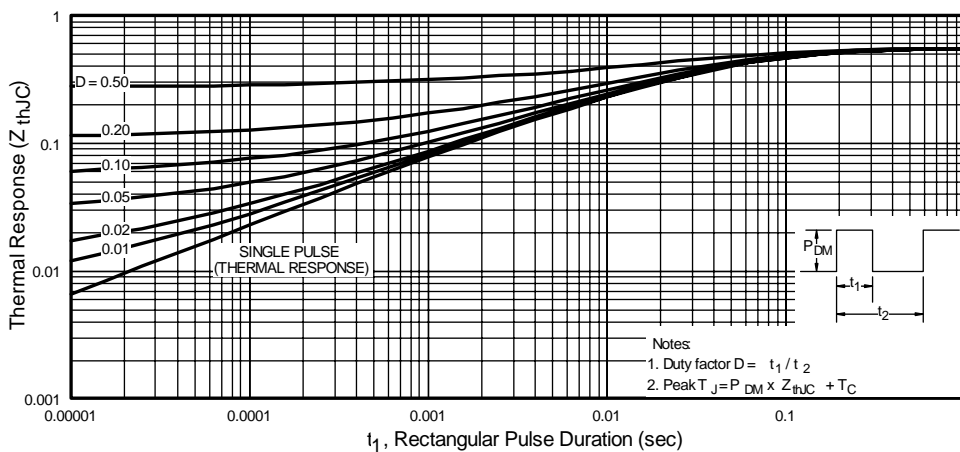
**Fig. 1** - Maximum Forward Voltage Drop vs. Instantaneous Forward Current, (per Leg)



**Fig. 2** - Typical Reverse Current vs. Reverse Voltage, (per Leg)



**Fig. 3** - Typical Junction Capacitance vs. Reverse Voltage, (per Leg)

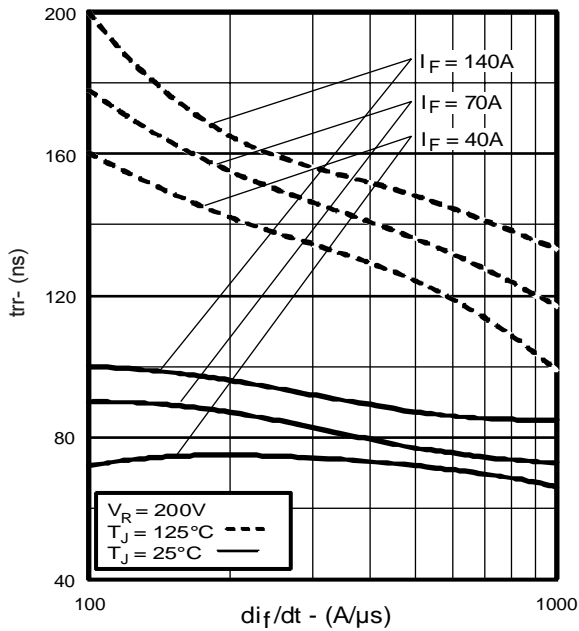


**Fig. 4** - Maximum Thermal Impedance  $Z_{thJC}$  Characteristics, (per Leg)

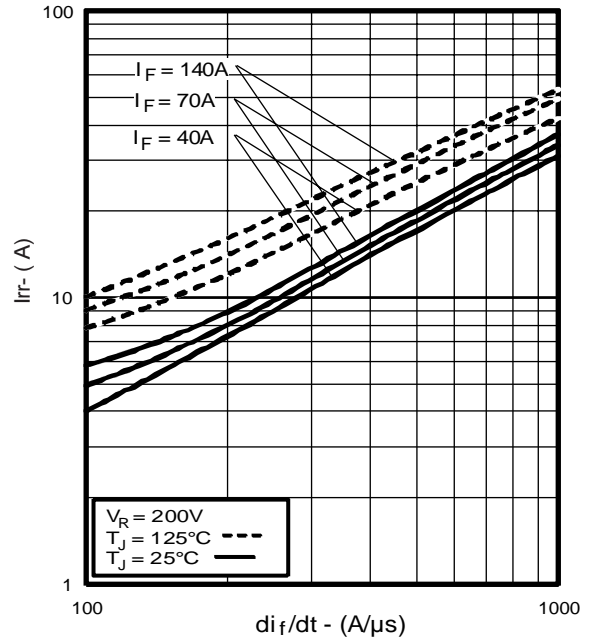
# HFA140MD60D

PD-40010 01/99

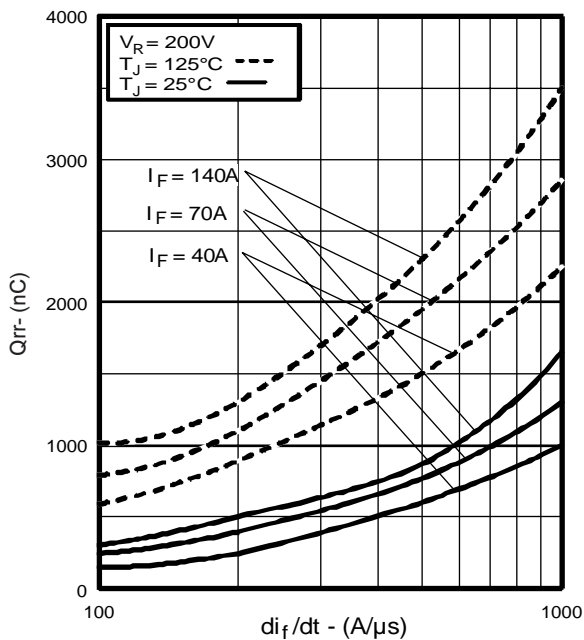
International  
**IOR** Rectifier



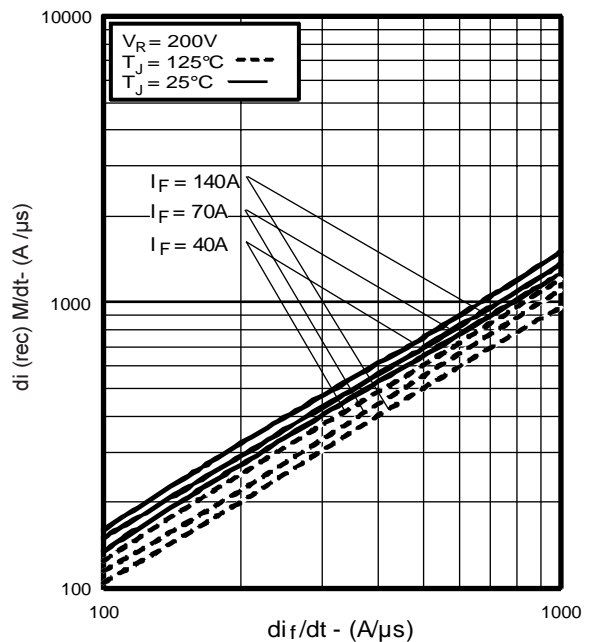
**Fig. 5** - Typical Reverse Recovery Time vs.  $di_f/dt$ , (per Leg)



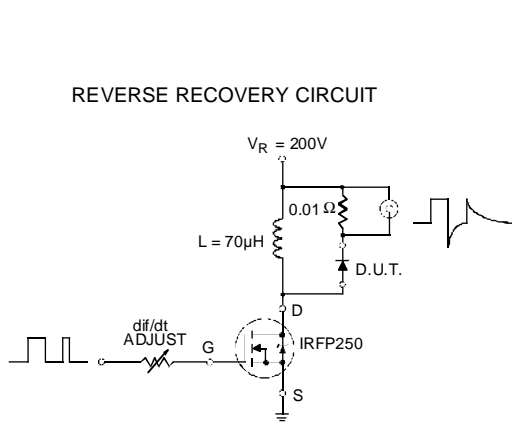
**Fig. 6** - Typical Recovery Current vs.  $di_f/dt$ , (per Leg)



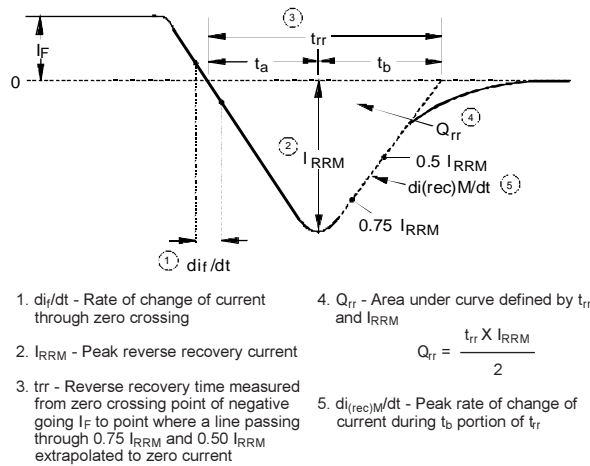
**Fig. 7** - Typical Stored Charge vs.  $di_f/dt$ , (per Leg)



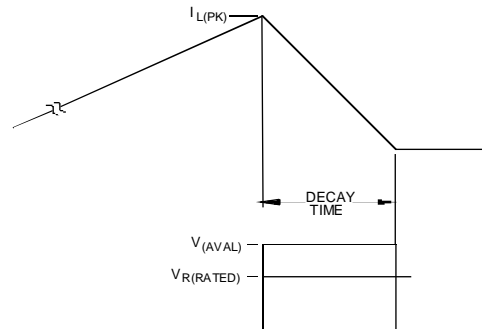
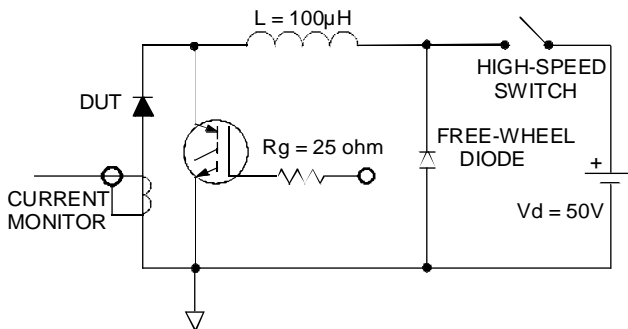
**Fig. 8** - Typical  $di_{(rec)}M/dt$  vs.  $di_f/dt$ , (per Leg)



**Fig. 9** - Reverse Recovery Parameter Test Circuit



**Fig. 10** - Reverse Recovery Waveform and Definitions



**Fig. 11** - Avalanche Test Circuit and Waveforms

单击下面可查看定价，库存，交付和生命周期等信息

[>>Vishay\(威世\)](#)