

Single-Line ESD-Protection Diode in SOD-523

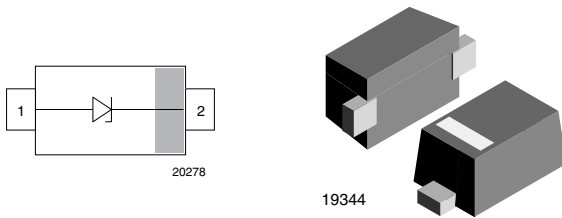

MARKING (example only)



Bar = cathode marking
 X = date code
 Y = type code (see table below)

FEATURES

- Compact SOD-523 package
- Low package height < 0.7 mm
- 1-line unidirectional ESD-protection
- AEC-Q101 qualified available
- Working range 1 V to 33 V
- ESD immunity acc. IEC 61000-4-2
 ±15 kV to ±30 kV contact discharge
 ±15 kV to ±30 kV air discharge
- Lead plating: Sn (e3)
 - soldering can be checked by standard vision inspection
 - AOI = Automated Optical Inspection
- Material categorization: for definitions of compliance please see www.vishay.com/doc?99912



LINKS TO ADDITIONAL RESOURCES



ORDERING INFORMATION					
PART NUMBER (EXAMPLE)	AEC-Q101 QUALIFIED	ENVIRONMENTAL AND QUALITY CODE			ORDERING CODE (EXAMPLE)
		RoHS COMPLIANT + LEAD (Pb)-FREE TERMINATIONS	TIN PLATED	8K PER 7" REEL (8 mm TAPE)	
		GREEN		MOQ = 8K/BOX	
VESD05C1-02V	-	G	3	-08	VESD05C1-02V-G3-08
VESD05C1-02V	H	G	3	-08	VESD05C1-02VHG3-08

PACKAGE DATA						
DEVICE NAME	PACKAGE NAME	TYPE CODE	WEIGHT	MOLDING COMPOUND FLAMMABILITY RATING	MOISTURE SENSITIVITY LEVEL	SOLDERING CONDITIONS
VESD01C1-02V	SOD-523	. V	1.32 mg	UL 94 V-0	MSL level 1 (according J-STD-020)	Peak temperature max. 260 °C
VESD03C1-02V		. B				
VESD05C1-02V		. C				
VESD08C1-02V		. D				
VESD12C1-02V		. E				
VESD16C1-02V		. F				
VESD26C1-02V		. X				
VESD33C1-02V		A				



ABSOLUTE MAXIMUM RATINGS VESD01C1-02V (T _{amb} = 25 °C, unless otherwise specified)				
PARAMETER	TEST CONDITIONS	SYMBOL	VALUE	UNIT
Peak pulse current	Acc. IEC 61000-4-5, 8/20 μs/single shot	I _{PPM}	14.6	A
Peak pulse power	Acc. IEC 61000-4-5, 8/20 μs/single shot	P _{PP}	100	W
ESD immunity	Contact discharge acc. IEC 61000-4-2; 10 pulses	V _{ESD}	30	kV
	Air discharge acc. IEC 61000-4-2; 10 pulses		30	kV
Operating temperature	Junction temperature	T _J	-55 to +150	°C
Storage temperature		T _{stg}	-55 to +150	°C

ABSOLUTE MAXIMUM RATINGS VESD03C1-02V (T _{amb} = 25 °C, unless otherwise specified)				
PARAMETER	TEST CONDITIONS	SYMBOL	VALUE	UNIT
Peak pulse current	Acc. IEC 61000-4-5, 8/20 μs/single shot	I _{PPM}	11.6	A
Peak pulse power	Acc. IEC 61000-4-5, 8/20 μs/single shot	P _{PP}	100	W
ESD immunity	Contact discharge acc. IEC 61000-4-2; 10 pulses	V _{ESD}	30	kV
	Air discharge acc. IEC 61000-4-2; 10 pulses		30	kV
Operating temperature	Junction temperature	T _J	-55 to +150	°C
Storage temperature		T _{stg}	-55 to +150	°C

ABSOLUTE MAXIMUM RATINGS VESD05C1-02V (T _{amb} = 25 °C, unless otherwise specified)				
PARAMETER	TEST CONDITIONS	SYMBOL	VALUE	UNIT
Peak pulse current	Acc. IEC 61000-4-5, 8/20 μs/single shot	I _{PPM}	8.7	A
Peak pulse power	Acc. IEC 61000-4-5, 8/20 μs/single shot	P _{PP}	100	W
ESD immunity	Contact discharge acc. IEC 61000-4-2; 10 pulses	V _{ESD}	30	kV
	Air discharge acc. IEC 61000-4-2; 10 pulses		30	kV
Operating temperature	Junction temperature	T _J	-55 to +150	°C
Storage temperature		T _{stg}	-55 to +150	°C

ABSOLUTE MAXIMUM RATINGS VESD08C1-02V (T _{amb} = 25 °C, unless otherwise specified)				
PARAMETER	TEST CONDITIONS	SYMBOL	VALUE	UNIT
Peak pulse current	Acc. IEC 61000-4-5, 8/20 μs/single shot	I _{PPM}	6.60	A
Peak pulse power	Acc. IEC 61000-4-5, 8/20 μs/single shot	P _{PP}	100	W
ESD immunity	Contact discharge acc. IEC 61000-4-2; 10 pulses	V _{ESD}	30	kV
	Air discharge acc. IEC 61000-4-2; 10 pulses		30	kV
Operating temperature	Junction temperature	T _J	-55 to +150	°C
Storage temperature		T _{stg}	-55 to +150	°C

**ABSOLUTE MAXIMUM RATINGS VESD12C1-02V**(T_{amb} = 25 °C, unless otherwise specified)

PARAMETER	TEST CONDITIONS	SYMBOL	VALUE	UNIT
Peak pulse current	Acc. IEC 61000-4-5, 8/20 µs/single shot	I _{PPM}	4.4	A
Peak pulse power	Acc. IEC 61000-4-5, 8/20 µs/single shot	P _{PP}	100	W
ESD immunity	Contact discharge acc. IEC 61000-4-2; 10 pulses	V _{ESD}	30	kV
	Air discharge acc. IEC 61000-4-2; 10 pulses		30	kV
Operating temperature	Junction temperature	T _J	-55 to +150	°C
Storage temperature		T _{stg}	-55 to +150	°C

ABSOLUTE MAXIMUM RATINGS VESD16C1-02V(T_{amb} = 25 °C, unless otherwise specified)

PARAMETER	TEST CONDITIONS	SYMBOL	VALUE	UNIT
Peak pulse current	Acc. IEC 61000-4-5, 8/20 µs/single shot	I _{PPM}	3.6	A
Peak pulse power	Acc. IEC 61000-4-5, 8/20 µs/single shot	P _{PP}	100	W
ESD immunity	Contact discharge acc. IEC 61000-4-2; 10 pulses	V _{ESD}	30	kV
	Air discharge acc. IEC 61000-4-2; 10 pulses		30	kV
Operating temperature	Junction temperature	T _J	-55 to +150	°C
Storage temperature		T _{stg}	-55 to +150	°C

ABSOLUTE MAXIMUM RATINGS VESD26C1-02V(T_{amb} = 25 °C, unless otherwise specified)

PARAMETER	TEST CONDITIONS	SYMBOL	VALUE	UNIT
Peak pulse current	Acc. IEC 61000-4-5, 8/20 µs/single shot	I _{PPM}	2.1	A
Peak pulse power	Acc. IEC 61000-4-5, 8/20 µs/single shot	P _{PP}	100	W
ESD immunity	Contact discharge acc. IEC 61000-4-2; 10 pulses	V _{ESD}	20	kV
	Air discharge acc. IEC 61000-4-2; 10 pulses		20	kV
Operating temperature	Junction temperature	T _J	-55 to +150	°C
Storage temperature		T _{stg}	-55 to +150	°C

ABSOLUTE MAXIMUM RATINGS VESD33C1-02V(T_{amb} = 25 °C, unless otherwise specified)

PARAMETER	TEST CONDITIONS	SYMBOL	VALUE	UNIT
Peak pulse current	Acc. IEC 61000-4-5, 8/20 µs/single shot	I _{PPM}	1.6	A
Peak pulse power	Acc. IEC 61000-4-5, 8/20 µs/single shot	P _{PP}	100	W
ESD immunity	Contact discharge acc. IEC 61000-4-2; 10 pulses	V _{ESD}	15	kV
	Air discharge acc. IEC 61000-4-2; 10 pulses		15	kV
Operating temperature	Junction temperature	T _J	-55 to +150	°C
Storage temperature		T _{stg}	-55 to +150	°C

**ELECTRICAL CHARACTERISTICS VESD01C1-02V**(T_{amb} = 25 °C, unless otherwise specified)

PARAMETER	TEST CONDITIONS / REMARKS	SYMBOL	MIN.	TYP.	MAX.	UNIT
Protection paths	Number of lines which can be protected	N _{channel}	-	-	1	lines
Reverse stand off voltage	Max. reverse working voltage	V _{RWM}	-	-	1	V
Reverse voltage	at I _R = 100 μA	V _R	1	1.2	-	V
Reverse current	at V _R = 1 V	I _R	-	20	100	μA
Reverse breakdown voltage	at I _R = 1 mA	V _{BR}	1.5	-	-	V
	at I _R = 20 mA	V _{BR}	2.5	2.65	2.8	V
Reverse clamping voltage	at I _{PP} = I _{PPM} = 14.6 A, t _p = 8/20 μs	V _C	-	6.2	6.9	V
Forward clamping voltage	at I _{PP} = 1 A, t _p = 300 μs	V _F	0.9	1.1	1.2	V
	at I _{PP} = I _{PPM} = 14.6 A, t _p = 8/20 μs	V _F	-	3	3.92	V
Dynamic resistance	t _p = 100 ns (TLP; pin 2-1)	r _{dyn}	-	0.13	-	Ω
Capacitance	at V _R = 0 V; f = 1 MHz	C _D	153	192	230	pF

ELECTRICAL CHARACTERISTICS VESD03C1-02V(T_{amb} = 25 °C, unless otherwise specified)

PARAMETER	TEST CONDITIONS / REMARKS	SYMBOL	MIN.	TYP.	MAX.	UNIT
Protection paths	Number of lines which can be protected	N _{channel}	-	-	1	lines
Reverse stand off voltage	Max. reverse working voltage	V _{RWM}	-	-	3	V
Reverse voltage	at I _R = 20 μA	V _R	3	-	-	V
Reverse current	at V _R = 3 V	I _R	-	8	20	μA
Reverse breakdown voltage	at I _R = 1 mA	V _{BR}	4.4	4.65	4.9	V
Reverse clamping voltage	at I _{PP} = I _{PPM} = 11.6 A, t _p = 8/20 μs	V _C	-	7.8	8.70	V
Forward clamping voltage	at I _{PP} = 1 A, t _p = 300 μs	V _F	0.9	1.1	1.2	V
	at I _{PP} = I _{PPM} = 11.6 A, t _p = 8/20 μs	V _F	-	2.6	3.32	V
Dynamic resistance	t _p = 100 ns (TLP; pin 2-1)	r _{dyn}	-	0.19	-	Ω
Capacitance	at V _R = 0 V; f = 1 MHz	C _D	89	112	135	pF

ELECTRICAL CHARACTERISTICS VESD05C1-02V(T_{amb} = 25 °C, unless otherwise specified)

PARAMETER	TEST CONDITIONS / REMARKS	SYMBOL	MIN.	TYP.	MAX.	UNIT
Protection paths	Number of lines which can be protected	N _{channel}	-	-	1	lines
Reverse stand off voltage	Max. reverse working voltage	V _{RWM}	-	-	5	V
Reverse voltage	at I _R = 1 μA	V _R	5	-	-	V
Reverse current	at V _R = 5 V	I _R	-	0.01	0.1	μA
Reverse breakdown voltage	at I _R = 1 mA	V _{BR}	6.85	7.26	7.65	V
Reverse clamping voltage	at I _{PP} = I _{PPM} = 8.7 A, t _p = 8/20 μs	V _C	-	10.3	11.5	V
Forward clamping voltage	at I _{PP} = 1 A, t _p = 300 μs	V _F	0.9	1.1	1.2	V
	at I _{PP} = I _{PPM} = 8.7 A, t _p = 8/20 μs	V _F	-	2.2	2.74	V
Dynamic resistance	t _p = 100 ns (TLP; pin 2-1)	r _{dyn}	-	0.2	-	Ω
Capacitance	at V _R = 0 V; f = 1 MHz	C _D	53	67	81	pF

**ELECTRICAL CHARACTERISTICS VESD08C1-02V**(T_{amb} = 25 °C, unless otherwise specified)

PARAMETER	TEST CONDITIONS / REMARKS	SYMBOL	MIN.	TYP.	MAX.	UNIT
Protection paths	Number of lines which can be protected	N _{channel}	-	-	1	lines
Reverse stand off voltage	Max. reverse working voltage	V _{RWM}	-	-	8	V
Reverse voltage	at I _R = 0.1 μA	V _R	8	-	-	V
Reverse current	at V _R = 8 V	I _R	-	0.01	0.1	μA
Reverse breakdown voltage	at I _R = 1 mA	V _{BR}	9.5	10	10.5	V
Reverse clamping voltage	at I _{PP} = I _{PPM} = 6.6 A, t _p = 8/20 μs	V _C	-	13.7	15.3	V
Forward clamping voltage	at I _{PP} = 1 A, t _p = 300 μs	V _F	0.9	1.1	1.2	V
	at I _{PP} = I _{PPM} = 6.6 A, t _p = 8/20 μs	V _F	-	1.9	2.32	V
Dynamic resistance	t _p = 100 ns (TLP; pin 2-1)	r _{dyn}	-	0.23	-	Ω
Capacitance	at V _R = 0 V; f = 1 MHz	C _D	37	47	57	pF

ELECTRICAL CHARACTERISTICS VESD12C1-02V(T_{amb} = 25 °C, unless otherwise specified)

PARAMETER	TEST CONDITIONS / REMARKS	SYMBOL	MIN.	TYP.	MAX.	UNIT
Protection paths	Number of lines which can be protected	N _{channel}	-	-	1	lines
Reverse stand off voltage	Max. reverse working voltage	V _{RWM}	-	-	12	V
Reverse voltage	at I _R = 0.1 μA	V _R	12	-	-	V
Reverse current	at V _R = 12 V	I _R	-	0.01	0.1	μA
Reverse breakdown voltage	at I _R = 1 mA	V _{BR}	13.9	14.7	15.5	V
Reverse clamping voltage	at I _{PP} = I _{PPM} = 4.4 A, t _p = 8/20 μs	V _C	-	20.5	22.7	V
Forward clamping voltage	at I _{PP} = 1 A, t _p = 300 μs	V _F	0.9	1.1	1.2	V
	at I _{PP} = I _{PPM} = 4.4 A, t _p = 8/20 μs	V _F	-	1.6	1.88	V
Dynamic resistance	t _p = 100 ns (TLP; pin 2-1)	r _{dyn}	-	0.4	-	Ω
Capacitance	at V _R = 0 V; f = 1 MHz	C _D	26	33	40	pF

ELECTRICAL CHARACTERISTICS VESD16C1-02V(T_{amb} = 25 °C, unless otherwise specified)

PARAMETER	TEST CONDITIONS / REMARKS	SYMBOL	MIN.	TYP.	MAX.	UNIT
Protection paths	Number of lines which can be protected	N _{channel}	-	-	1	lines
Reverse stand off voltage	Max. reverse working voltage	V _{RWM}	-	-	16	V
Reverse voltage	at I _R = 0.1 μA	V _R	16	-	-	V
Reverse current	at V _R = 16 V	I _R	-	0.01	0.1	μA
Reverse breakdown voltage	at I _R = 1 mA	V _{BR}	17	17.9	18.8	V
Reverse clamping voltage	at I _{PP} = I _{PPM} = 3.6 A, t _p = 8/20 μs	V _C	-	25.3	28	V
Forward clamping voltage	at I _{PP} = 1 A, t _p = 300 μs	V _F	0.9	1.1	1.2	V
	at I _{PP} = I _{PPM} = 3.6 A, t _p = 8/20 μs	V _F	-	1.5	1.72	V
Dynamic resistance	t _p = 100 ns (TLP; pin 2-1)	r _{dyn}	-	0.53	-	Ω
Capacitance	at V _R = 0 V; f = 1 MHz	C _D	21	27	33	pF

**ELECTRICAL CHARACTERISTICS VESD26C1-02V**(T_{amb} = 25 °C, unless otherwise specified)

PARAMETER	TEST CONDITIONS / REMARKS	SYMBOL	MIN.	TYP.	MAX.	UNIT
Protection paths	Number of lines which can be protected	N _{channel}	-	-	1	lines
Reverse stand off voltage	Max. reverse working voltage	V _{RWM}	-	-	26	V
Reverse voltage	at I _R = 0.1 μA	V _R	26	-	-	V
Reverse current	at V _R = 26 V	I _R	-	< 0.01	0.1	μA
Reverse breakdown voltage	at I _R = 1 mA	V _{BR}	27.6	29.1	30.6	V
Reverse clamping voltage	at I _{PP} = I _{PPM} = 2.1 A, t _p = 8/20 μs	V _C	-	43	48	V
Forward clamping voltage	at I _{PP} = 1 A, t _p = 300 μs	V _F	0.9	1.1	1.2	V
	at I _{PP} = I _{PPM} = 2.1 A, t _p = 8/20 μs	V _F	-	1.3	1.42	V
Dynamic resistance	t _p = 100 ns (TLP; pin 2-1)	r _{dyn}	-	1.9	-	Ω
Capacitance	at V _R = 0 V; f = 1 MHz	C _D	14	17.5	21	pF

ELECTRICAL CHARACTERISTICS VESD33C1-02V(T_{amb} = 25 °C, unless otherwise specified)

PARAMETER	TEST CONDITIONS / REMARKS	SYMBOL	MIN.	TYP.	MAX.	UNIT
Protection paths	Number of lines which can be protected	N _{channel}	-	-	1	lines
Reverse stand off voltage	Max. reverse working voltage	V _{RWM}	-	-	33	V
Reverse voltage	at I _R = 0.1 μA	V _R	33	-	-	V
Reverse current	at V _R = 33 V	I _R	-	< 0.01	0.1	μA
Reverse breakdown voltage	at I _R = 1 mA	V _{BR}	35.5	37.4	39.3	V
Reverse clamping voltage	at I _{PP} = I _{PPM} = 1.6 A, t _p = 8/20 μs	V _C	-	56	62.5	V
Forward clamping voltage	at I _{PP} = 1 A, t _p = 300 μs	V _F	0.9	1.1	1.2	V
	at I _{PP} = I _{PPM} = 1.6 A, t _p = 8/20 μs	V _F	-	1.22	1.32	V
Dynamic resistance	t _p = 100 ns (TLP; pin 2-1)	r _{dyn}	-	3.6	-	Ω
Capacitance	at V _R = 0 V; f = 1 MHz	C _D	12	15	18	pF

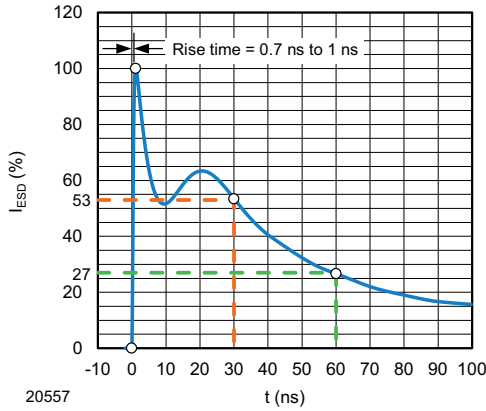

Fig. 1 - ESD Discharge Current Wave Form acc. IEC 61000-4-2 (330 Ω / 150 pF)

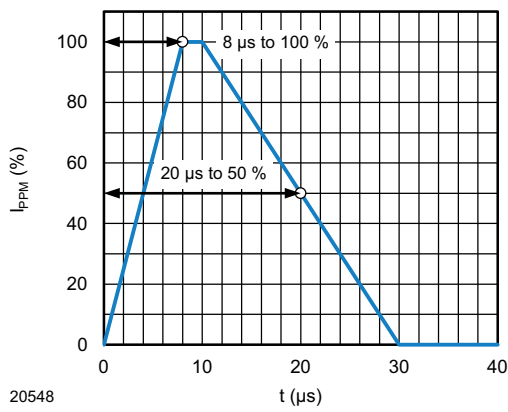

Fig. 2 - 8/20 μs Peak Pulse Current Wave Form acc. IEC 61000-4-5

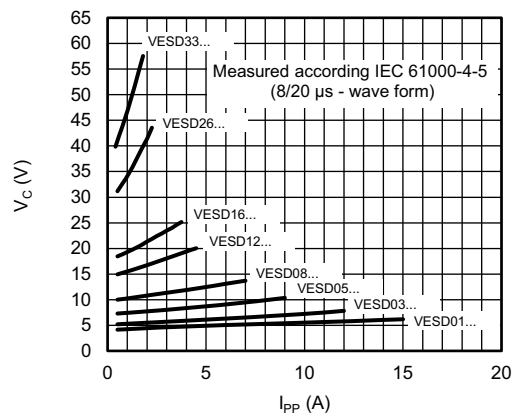

Fig. 3 - Typical Peak Clamping Voltage vs. Peak Pulse Current

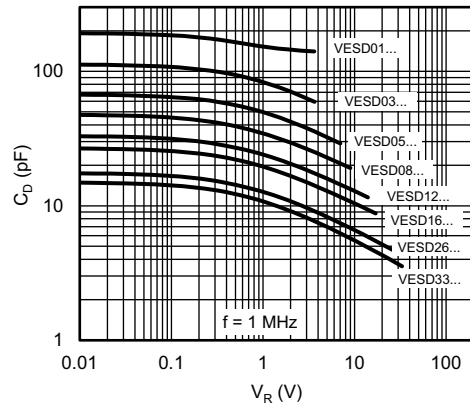

Fig. 4 - Typical Capacitance vs. Reverse Voltage

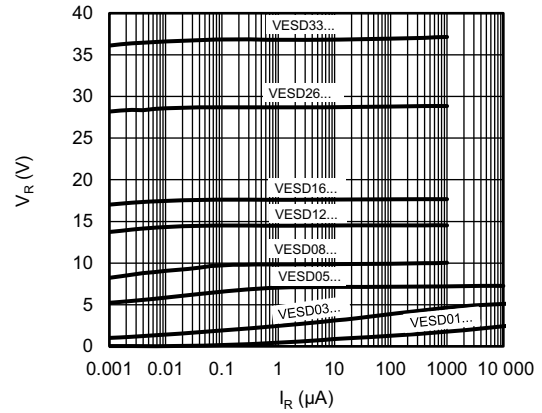

Fig. 5 - Typical Reverse Voltage vs. Reverse Current

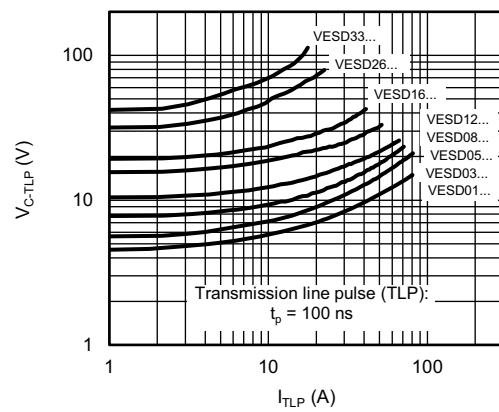

Fig. 6 - Typical Clamping Voltage vs. Peak Pulse Current

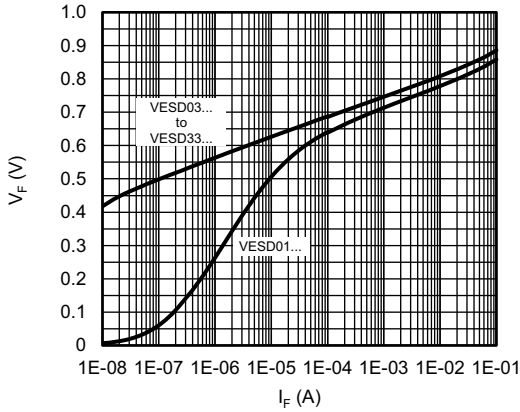

Fig. 7 - Typical Forward Voltage vs. Forward Current

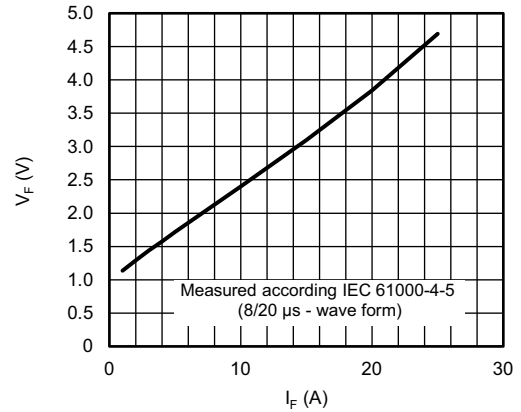
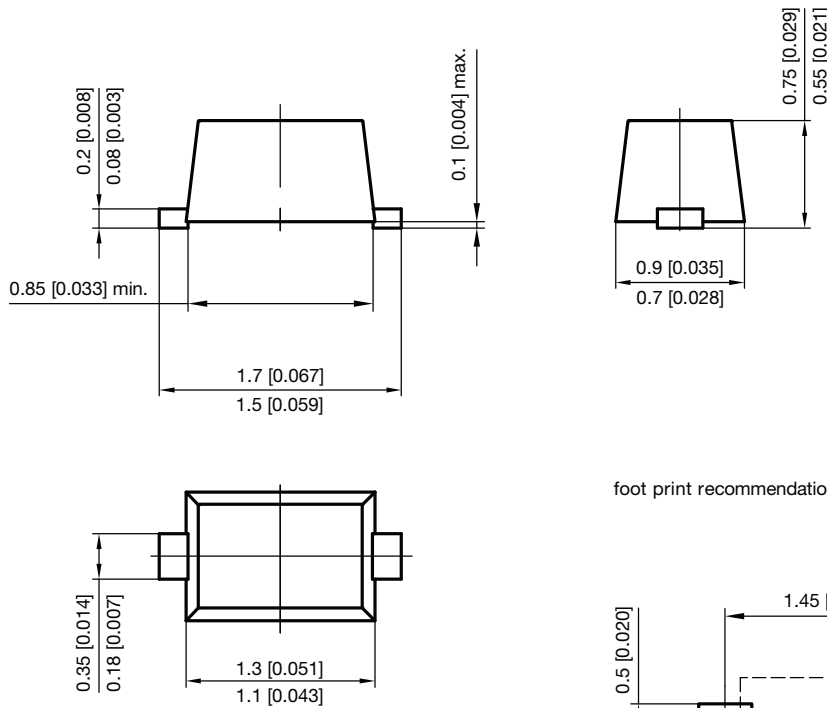

Fig. 8 - Typical Forward Voltage vs. Forward Current

PACKAGE DIMENSIONS in millimeters (Inches): SOD-523



foot print recommendation:

Document no.: S8-V-3880.02-003 (4)
 Created - Date: 04. April 2017
 Rev. 3 - Date: 27. May 2019
 23093



CARRIER TAPE SOD-523

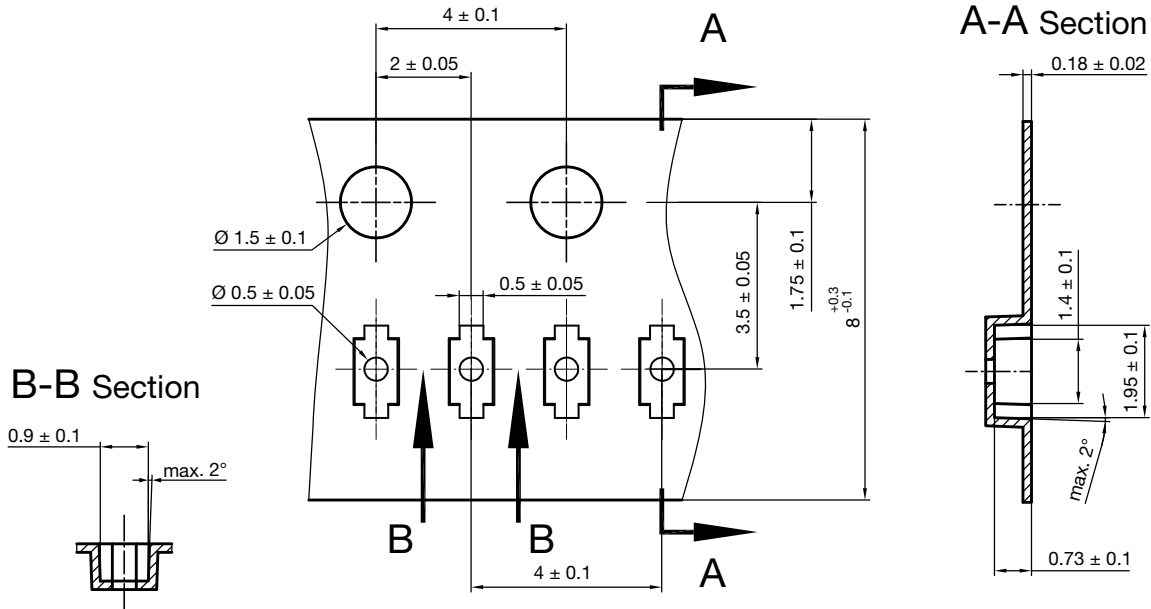

S8-V-3717.03-005 (4)
05.07.2018
22959

ORIENTATION IN CARRIER TAPE SOD-523

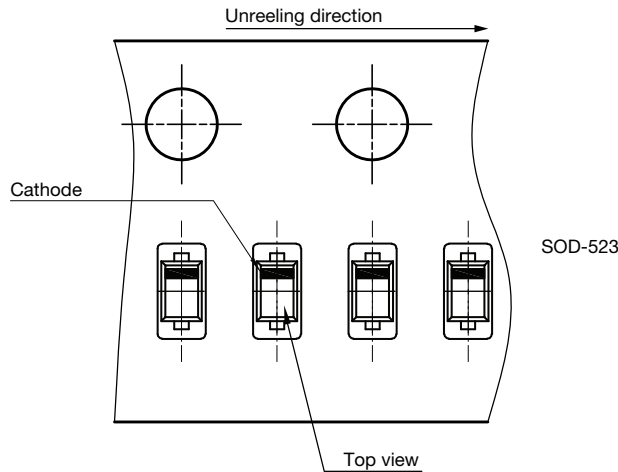

S8-V-3717.03-006 (4)
05.07.2018
22958



Disclaimer

ALL PRODUCT, PRODUCT SPECIFICATIONS AND DATA ARE SUBJECT TO CHANGE WITHOUT NOTICE TO IMPROVE RELIABILITY, FUNCTION OR DESIGN OR OTHERWISE.

Vishay Intertechnology, Inc., its affiliates, agents, and employees, and all persons acting on its or their behalf (collectively, "Vishay"), disclaim any and all liability for any errors, inaccuracies or incompleteness contained in any datasheet or in any other disclosure relating to any product.

Vishay makes no warranty, representation or guarantee regarding the suitability of the products for any particular purpose or the continuing production of any product. To the maximum extent permitted by applicable law, Vishay disclaims (i) any and all liability arising out of the application or use of any product, (ii) any and all liability, including without limitation special, consequential or incidental damages, and (iii) any and all implied warranties, including warranties of fitness for particular purpose, non-infringement and merchantability.

Statements regarding the suitability of products for certain types of applications are based on Vishay's knowledge of typical requirements that are often placed on Vishay products in generic applications. Such statements are not binding statements about the suitability of products for a particular application. It is the customer's responsibility to validate that a particular product with the properties described in the product specification is suitable for use in a particular application. Parameters provided in datasheets and / or specifications may vary in different applications and performance may vary over time. All operating parameters, including typical parameters, must be validated for each customer application by the customer's technical experts. Product specifications do not expand or otherwise modify Vishay's terms and conditions of purchase, including but not limited to the warranty expressed therein.

Except as expressly indicated in writing, Vishay products are not designed for use in medical, life-saving, or life-sustaining applications or for any other application in which the failure of the Vishay product could result in personal injury or death. Customers using or selling Vishay products not expressly indicated for use in such applications do so at their own risk. Please contact authorized Vishay personnel to obtain written terms and conditions regarding products designed for such applications.

No license, express or implied, by estoppel or otherwise, to any intellectual property rights is granted by this document or by any conduct of Vishay. Product names and markings noted herein may be trademarks of their respective owners.

单击下面可查看定价，库存，交付和生命周期等信息

[>>Vishay\(威世\)](#)