

Ultra High Precision, Surface Mount 4-Terminal Precision Resistor with Increased Power to 5W (40A max), Resistance Values from 3 mΩ to 100 mΩ, and TCR to ± 15 ppm/°C

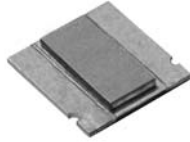

INTRODUCTION

The CSM3637P is a low value current sense resistor, providing power and precision in a four terminal, surface mount configuration. Its all welded construction is made up of a Bulk Metal[®] resistive element with plated copper terminations.

There are many current sense resistors on the market. Until now the combination of very stable and precise resistors with low TCR of ± 15 ppm/°C maximum, tight tolerance of ± 0.1 % and load life stability of ± 0.2 % (2000 h, + 70 °C at rated power) was not easily available.

The key performance of the new CSM3637P is its high rated power up to 5W. This option became available due to a special design which consists of a heat sink on the top of the resistive element, thus allowing a better heat dissipation.

These specifications are based on tests performed in accordance with methods prescribed by appropriate MIL-PRF standards (MIL-PRF-55342 and MIL-PRF-49465).

The four terminal device separates the current leads from the voltage sensing leads. This configuration eliminates the effect of the lead wire resistance from points A to B and C to D.

In addition, a key feature of the CSM3637P is its low thermal EMF design (very important for low ohmic value DC applications). The welded terminals make intimate contact with the chip thereby minimizing temperature differentials.

Our application engineering department is available to advise and make recommendations.

For non-standard technical requirements and special applications, please contact: foil@vpgsensors.com

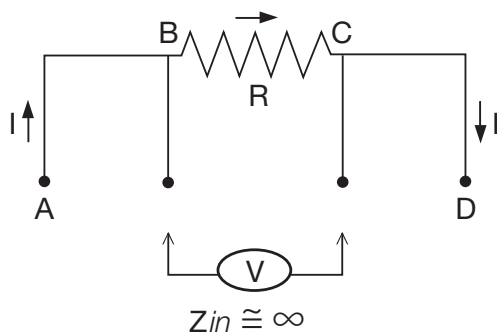

FEATURES

- Resistance range: 3 mΩ to 100 mΩ
- Temperature coefficient of resistance (TCR): 3 mΩ to 100mΩ : 15 ppm/°C maximum
- Load life stability: ± 0.2 % (70 °C, 2000 h at rated power)
- **Power rating: to 5 W (see Table 1)**
- Resistance tolerance: to ± 0.1 %
- Vishay Foil Resistors (VFR) are not restricted to standard values; specific "as required" values can be supplied at no extra cost or delivery (e.g. 10.2345 mΩ vs. 10 mΩ)
- Short time overload: ± 0.2 % typical
- Proprietary processing technique produces extremely low resistance values with improved stability
- All welded construction
- Solderable terminations
- Very low inductance 0.5 nH
- Excellent frequency response to 50 MHz
- Low thermal EMF < 3 μV/°C (DC offset error, significant for low values)
- **Maximum current: up to 40 A**
- Four terminal (Kelvin) design: allows for precise and accurate measurements
- Terminal finishes available: lead (Pb)-free, tin/lead alloy
- Prototype quantities available in just 5 working days or sooner. For more information, please contact foil@vpgsensors.com
- For better performances, please contact us



RoHS*
COMPLIANT

FIGURE 1 - POWER DERATING CURVE

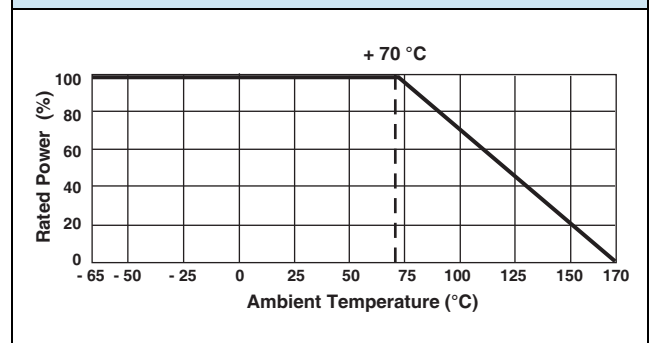

* This datasheet provides information about parts that are RoHS-compliant and/or parts that are non-RoHS-compliant. For example, parts with lead (Pb) terminations are not RoHS-compliant. Please see the information/tables in this datasheet for details.

ABOUT CSM3637P

This new high-precision Bulk Metal[®] surface-mount Power Metal Strip[®] resistor features an improved load-life stability of $\pm 0.2\%$ at $+70\text{ }^{\circ}\text{C}$ for 2000 h at rated power, an absolute TCR of $\pm 15\text{ ppm}/^{\circ}\text{C}$ maximum from $-55\text{ }^{\circ}\text{C}$ to $+125\text{ }^{\circ}\text{C}$, $+25\text{ }^{\circ}\text{C}$ ref., and a tolerance of $\pm 0.1\%$.

Typical current sensing resistors exhibit 2000 hour load-life changes more than 5 times greater than the CSM3637P. The improved resistance stability of the CSM Series makes it ideal for tightened-stability voltage division and precision current sensing applications in switching linear power supplies, power amplifiers, measurement instrumentation, bridge networks, and medical and test equipment.

Traditional Passive current sensors and shunts generate heat under power, which changes their resistance, and thus their voltage output. The CSM's low absolute TCR of $\pm 15\text{ ppm}/^{\circ}\text{C}$ reduces errors due to temperature changes, thus reducing a major source of uncertainty in current measurement. The CSM can withstand unconventional environmental conditions, including the extremely high temperatures and radiation-rich environments of down-hole oil exploration and well logging, or the deep-sea underwater repeaters in cross-ocean communications.

The stability of the CSM3637P can be further enhanced by post-manufacturing operations (PMO), such as temperature cycling, short-time overload, and accelerated load life which are uniquely applicable to Bulk Metal[®] Foil Technology.

The device features a low thermal electromotive force (EMF) that is critical in many precision DC applications. The CSM's all-welded construction is composed of a Bulk Metal[®] resistive element with welded copper terminations, plated for soldering. The terminations make true ohmic contact with the resistive layer along the entire side of the resistive element, thereby minimizing temperature variations. Also, the resistor element is designed to uniformly dissipate power without creating hot spots, and the welded terminations material is compatible with the element material.

These design factors result in a very low thermal-EMF ($3\text{ }\mu\text{V}/^{\circ}\text{C}$) resistor because, in addition to the low thermal EMF compatibility of the metals, the uniformity and thermal efficiency of the design minimizes the temperature differential across the resistor, thereby assuring low thermal EMF generation at the leads. This further reduces the "battery effect" exhibited by most current-sensing or voltage-reference resistors. Thus, the parasitic voltage generated at the junction of two dissimilar metals, which is especially important in low-value DC current-sensing resistors, is minimized, while the pure current-to-voltage

conversion is protected from such interference in DC applications.

The stability problems associated with analog circuits are very pervasive, but knowledgeable selection of a few high-quality resistors, networks, or trimming potentiometers in critical locations can greatly improve circuit performance, long-term application-related performance, as well as the designer's peace-of-mind.

Additionally, the overall system cost is often reduced when a knowledgeable designer concentrates costs in a few exceptionally stable components whose proven minimal-deviation load and environmental stability can often eliminate the necessity of additional compensating circuitry or temperature-controlling systems. The higher reliability and better overall system performances also achieve excellent product results in the field, enhancing market acceptance and product reputation.

Designers often unnecessarily pay for tighter tolerances than required simply to accommodate the resistance stability shifts they know to be imminent in an application due to the large application-related changes in the components they selected. Selection of a high-stability component like the CSM in these applications eliminates the need for shift allowance due to "planned instability" and allows the use of looser initial tolerances than would be necessary with current-sensing resistors based on other technologies.

The Key Applications

Applications requiring accuracy and repeatability under stress conditions such as the following:

- Switching and linear power supplies
- Precision current-sensing
- Power management systems
- Feedback circuits
- Power amplifiers
- Measurement instrumentation
- Precision instrumentation amplifiers
- Medical and automatic test equipment
- Satellites and aerospace systems
- Commercial and Military avionics
- Test and measurement equipment
- Electronic scales

TABLE 1 - SPECIFICATIONS

PARAMETER	CSM3637P
Resistance Range	3 mΩ to 100 mΩ
Power Rating at 70 °C in free air	5W (3mΩ to 10mΩ) 4W (>10mΩ to 100mΩ)
Maximum Current	40 A
Tightest Tolerance	± 0.1 %
Temperature Coefficient Of Resistance (TCR) (- 55 °C to + 125 °C, + 25 °C ref.)	3 mΩ to 100mΩ :15 ppm/°C maximum
Thermal EMF	< 3 μV/°C
Operating Temperature Range	- 65 °C to + 170 °C
Weight (maximum)	0.38 g

FIGURE 2 - DIMENSIONS AND IMPRINTING in inches (millimeters)

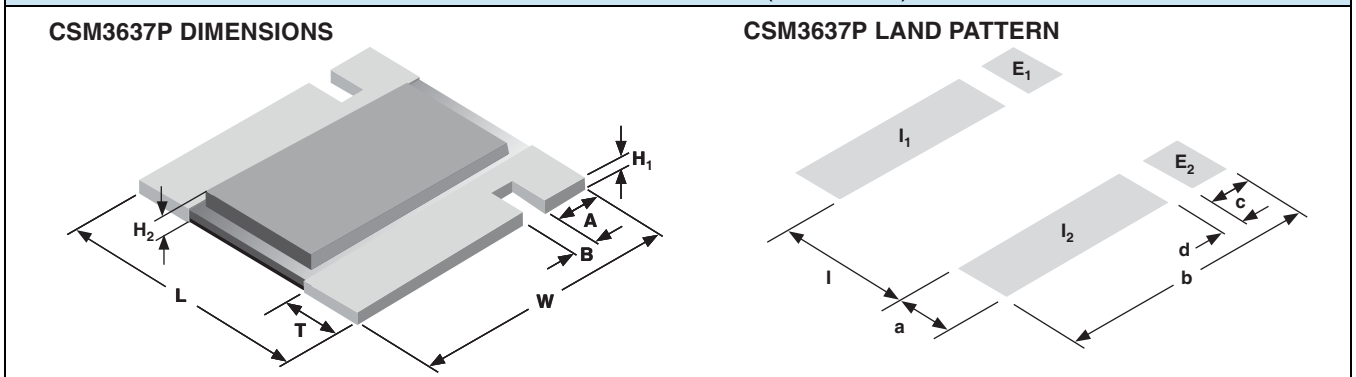

DIMENSIONS - TOLERANCES ± 0.010 (± 0.254)

RESISTANCE RANGE (mΩ)	L	W	H ₁	H ₂	T	A	B
3 to 100	0.360 (9.144)	0.370 (9.398)	0.025 (0.635)	0.060 (1.524) max	0.086 (2.184)	0.061 (1.549)	0.032 (0.813)

LAND PATTERN DIMENSIONS - TOLERANCES ± 0.003 (± 0.076)

RESISTANCE RANGE (mΩ)	l	b			a	c	d
3 to 100	0.178 (4.52)	0.390 (9.91)	-	-	0.116 (2.95)	0.066 (1.68)	0.024 (0.610)

CSM3637P CONSTRUCTION

1. Resistive element
2. Copper terminal with solderable finish
3. Terminal-to-element weld
4. Thermal conductive adhesive
5. Anodized aluminum heat sink

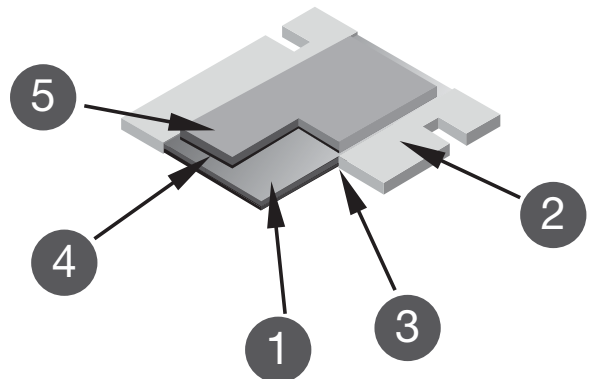

TABLE 2 - CSM3637P ENVIRONMENTAL PERFORMANCE COMPARISON 3 mΩ to 100 mΩ				
TEST	CONDITIONS	MIL-PRF-49465B ΔR LIMITS	TYPICAL ΔR LIMITS	MAXIMUM ΔR LIMITS ⁽¹⁾
Thermal Cycling	- 55 °C to + 125 °C, 1000 cycles, 15 min at each extreme	± (0.5 % + 0.0005R)	0.1 %	0.3 %
Load Life Stability	2000 h, 70 °C at rated power	± (1.0 % + 0.0005R)	0.2 %	0.6 %
Bias Humidity	85 °C, 85 % humidity, 10 % bias, 1000 h	± (0.5 % + 0.0005R)	0.05 %	0.2 %
Short Time Overload	2.5 x rated power for 5 s	± (0.5 % + 0.0005R)	0.2 %	0.5 %
High Temperature Exposure	1000 h, 170 °C	± (1.0 % + 0.0005R)	0.2 %	0.3 %
Low Temperature Storage	MIL-PRF-49465	± (0.5 % + 0.0005R)	0.05 %	0.1 %
Moisture Resistance	MIL-STD-202, method 106, 0 % power, 7a and 7b not required	± (0.5 % + 0.0005R)	0.02 %	0.05 %
Shock	100 g, 6 ms	± (0.1 % + 0.0005R)	0.02 %	0.05 %
Vibration	(10 Hz to 2000 Hz) 20 g	± (0.1 % + 0.0005R)	0.02 %	0.05 %
Resistance to Soldering Heat	10 s to 12 s at + 260 °C	± (0.25 % + 0.0005R)	0.05 %	0.1 %
Solderability	MIL-STD-202	95 % coverage	-	

(1) Add 0.0005R as per MIL-PRF-49465B

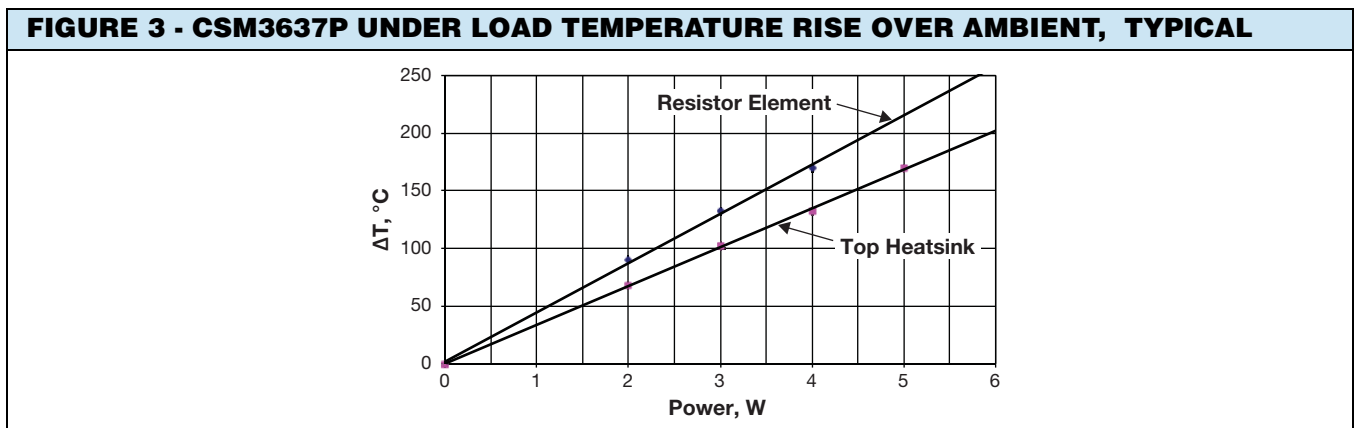
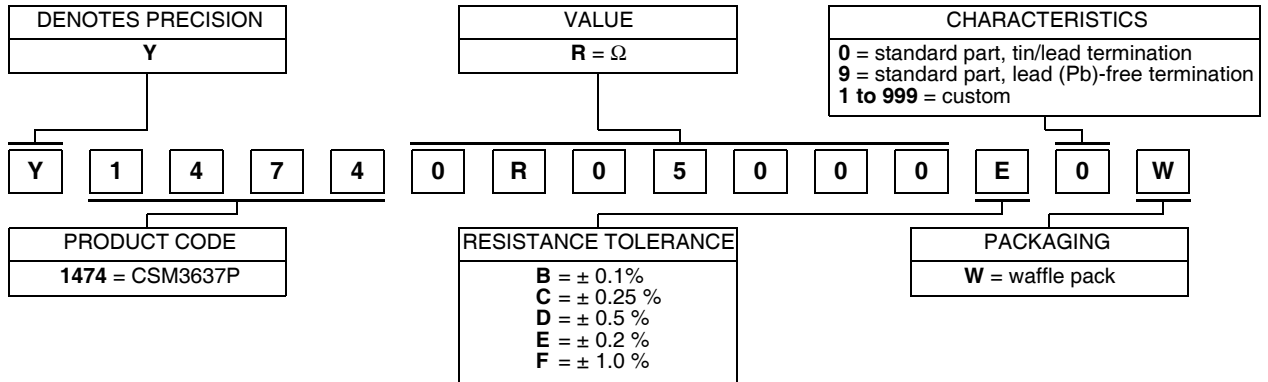

TABLE 3 - GLOBAL PART NUMBER INFORMATION (1)

NEW GLOBAL PART NUMBER: Y14740R05000E0W (preferred part number format)



FOR EXAMPLE: ABOVE GLOBAL ORDER Y1474 0R05000 E 0 W:

TYPE: CSM3637P
VALUE: 50 mΩ
ABSOLUTE TOLERANCE: ± 0.2 %
TERMINATION: standard tin/lead
PACKAGING: waffle pack

HISTORICAL PART NUMBER: CSM3637P 0R05 E B T (will continue to be used)

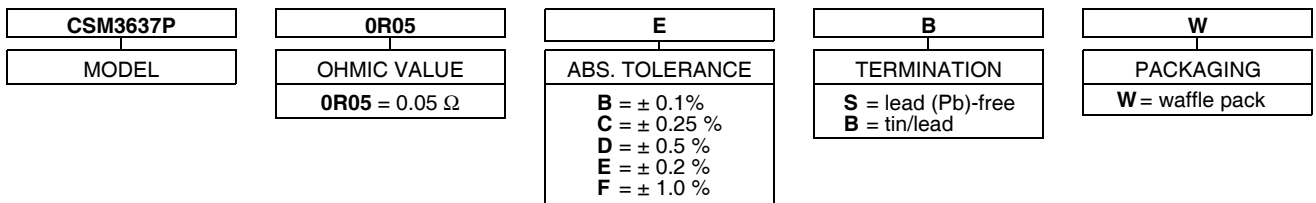

Note

(1) For non-standard requests, please contact application engineering.

Disclaimer

ALL PRODUCTS, PRODUCT SPECIFICATIONS AND DATA ARE SUBJECT TO CHANGE WITHOUT NOTICE.

Vishay Precision Group, Inc., its affiliates, agents, and employees, and all persons acting on its or their behalf (collectively, "VPG"), disclaim any and all liability for any errors, inaccuracies or incompleteness contained herein or in any other disclosure relating to any product.

The product specifications do not expand or otherwise modify VPG's terms and conditions of purchase, including but not limited to, the warranty expressed therein.

VPG makes no warranty, representation or guarantee other than as set forth in the terms and conditions of purchase. **To the maximum extent permitted by applicable law, VPG disclaims (i) any and all liability arising out of the application or use of any product, (ii) any and all liability, including without limitation special, consequential or incidental damages, and (iii) any and all implied warranties, including warranties of fitness for particular purpose, non-infringement and merchantability.**

Information provided in datasheets and/or specifications may vary from actual results in different applications and performance may vary over time. Statements regarding the suitability of products for certain types of applications are based on VPG's knowledge of typical requirements that are often placed on VPG products. It is the customer's responsibility to validate that a particular product with the properties described in the product specification is suitable for use in a particular application. You should ensure you have the current version of the relevant information by contacting VPG prior to performing installation or use of the product, such as on our website at vpgsensors.com.

No license, express, implied, or otherwise, to any intellectual property rights is granted by this document, or by any conduct of VPG.

The products shown herein are not designed for use in life-saving or life-sustaining applications unless otherwise expressly indicated. Customers using or selling VPG products not expressly indicated for use in such applications do so entirely at their own risk and agree to fully indemnify VPG for any damages arising or resulting from such use or sale. Please contact authorized VPG personnel to obtain written terms and conditions regarding products designed for such applications.

Product names and markings noted herein may be trademarks of their respective owners.

Copyright Vishay Precision Group, Inc., 2014. All rights reserved.

单击下面可查看定价，库存，交付和生命周期等信息

[>>Vishay\(威世\)](#)