

High Voltage Ceramic Capacitors Radial-Leaded Singlelayer Disc



LINKS TO ADDITIONAL RESOURCES



3D Models



Related Documents



Why It Matters



Capabilities and Custom Options



Did You Know?



Infographics

QUICK REFERENCE DATA			
DESCRIPTION	VALUE		
Ceramic class	2		
Ceramic dielectric	Y6P		
Temperature coefficient of capacitance	± 10 % within -30 °C to +105 °C		
Voltage (U _{rated, DC})	10 000	15 000	20 000
Min. capacitance (pF)	100	100	100
Max. capacitance (pF)	2000	2000	1000
Capacitance tolerance	± 20 %, ± 10 %		
Max. dissipation factor (%)	1.5		
Min. insulation resistance (GΩ)	200		
Operating temperature (°C)	-30 to +105		
Mounting	Radial		

RATED VOLTAGE

 $U_{\text{rated, AC}} = U_{\text{rated, DC}} / 2.8$ at 50 Hz / 60 Hz

 $U_{\text{rated, DC}}: 10\,000\text{ V} \rightarrow U_{\text{rated, AC}}: 3500\text{ V}$
 $U_{\text{rated, DC}}: 15\,000\text{ V} \rightarrow U_{\text{rated, AC}}: 5300\text{ V}$
 $U_{\text{rated, DC}}: 20\,000\text{ V} \rightarrow U_{\text{rated, AC}}: 7000\text{ V}$

INSULATION RESISTANCE

 Min. 200 000 MΩ at 500 V_{DC} / 60 s max.

TOLERANCE ON CAPACITANCE

± 20 %, ± 10 %

DISSIPATION FACTOR

Max. 1.5 % at 1 kHz

OPERATING TEMPERATURE RANGE

-30 °C to +105 °C

FEATURES

- Ceramic singlelayer DC disc / AC disc capacitor
- High reliability
- High capacitance values up to 2 nF
- Small sizes
- Low losses
- Radial leads
- Material categorization: for definitions of compliance please see www.vishay.com/doc?99912

RoHS
COMPLIANT

APPLICATIONS

- High voltage power supplies for x-ray sources and pulsed lasers
- Baggage scanner
- Medical x-ray
- Industrial laser
- Airpurifier / ionizer

DESIGN

The capacitors consist of a ceramic disc of which both sides are silver-plated. Connection leads are made of tinned copper clad steel wire having diameters of 0.026" (0.65 mm) and 0.032" (0.80 mm).

The capacitors may be supplied with straight leads having lead spacing of 0.37" (9.5 mm) and 0.49" (12.5 mm).

Coating is made of flame retardant epoxy resin in accordance with "UL 94 V-0".

CAPACITANCE RANGE

100 pF to 2000 pF

DIELECTRIC STRENGTH BETWEEN LEADS

 $1.5 \times U_{\text{rated, DC}}$ for maximum 60 s

Test voltage: customer re-test $1.35 \times U_{\text{rated, DC}}$ for maximum 60 s

Notes

- Considered as destructive test in insulation liquid
- Avoid flashover between wires and currents higher than 50 mA

CERAMIC DIELECTRIC

Y6P (± 10 % within -30 °C to +105 °C)

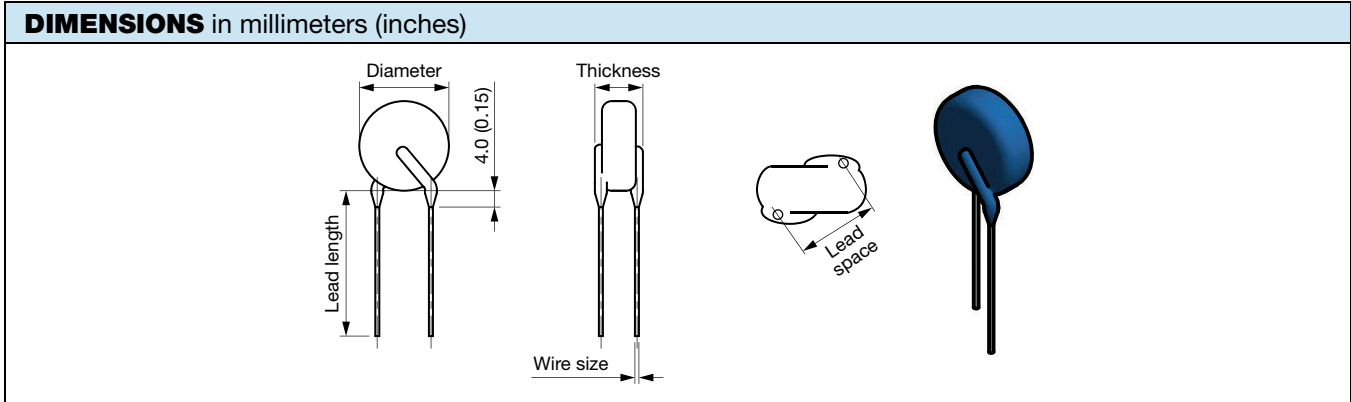

ORDERING INFORMATION, 10 kV_{DC}												
C (pF)	TOL. (%)	MAXIMUM DIAMETER		MAXIMUM THICKNESS		LEAD SPACE ± 1 mm (± 0.04")		WIRE SIZE ± 0.05 mm (± 0.002")		LEAD LENGTH ± 5 mm (± 0.2")		ORDERING CODE
		mm	INCH	mm	INCH	mm	INCH	mm	INCH	mm	INCH	
100	± 20	8.0	0.31	9.0	0.35	12.5 and 9.5	0.49 and 0.37	0.80 and 0.65	0.032 and 0.026	30	1.18	HVCC103Y6P101M###
100	± 10	8.0	0.31	9.0	0.35							HVCC103Y6P101K###
150	± 20	8.0	0.31	8.0	0.31							HVCC103Y6P151M###
150	± 10	8.0	0.31	8.0	0.31							HVCC103Y6P151K###
220	± 20	9.0	0.35	8.0	0.31							HVCC103Y6P221M###
220	± 10	9.0	0.35	8.0	0.31							HVCC103Y6P221K###
330	± 20	10.0	0.39	8.0	0.31							HVCC103Y6P331M###
330	± 10	10.0	0.39	8.0	0.31							HVCC103Y6P331K###
470	± 20	12.0	0.47	8.0	0.31							HVCC103Y6P471M###
470	± 10	12.0	0.47	8.0	0.31							HVCC103Y6P471K###
680	± 20	13.0	0.51	7.5	0.30							HVCC103Y6P681M###
680	± 10	13.0	0.51	7.5	0.30							HVCC103Y6P681K###
1000	± 20	15.0	0.59	7.5	0.30							HVCC103Y6P102M###
1000	± 10	15.0	0.59	7.5	0.30							HVCC103Y6P102K###
1500	± 20	17.0	0.67	7.5	0.30							HVCC103Y6P152M###
1500	± 10	17.0	0.67	7.5	0.30							HVCC103Y6P152K###
2000	± 20	19.0	0.75	8.0	0.31							HVCC103Y6P202M###

ORDERING INFORMATION, 15 kV_{DC}												
C (pF)	TOL. (%)	MAXIMUM DIAMETER		MAXIMUM THICKNESS		LEAD SPACE ± 1 mm (± 0.04")		WIRE SIZE ± 0.05 mm (± 0.002")		LEAD LENGTH ± 5 mm (± 0.2")		ORDERING CODE
		mm	INCH	mm	INCH	mm	INCH	mm	INCH	mm	INCH	
100	± 20	8.0	0.31	9.0	0.35	12.5 and 9.5	0.49 and 0.37	0.80 and 0.65	0.032 and 0.026	30	1.18	HVCC153Y6P101M###
100	± 10	8.0	0.31	9.0	0.35							HVCC153Y6P101K###
150	± 20	8.0	0.31	8.0	0.31							HVCC153Y6P151M###
150	± 10	8.0	0.31	8.0	0.31							HVCC153Y6P151K###
220	± 20	9.0	0.35	8.0	0.31							HVCC153Y6P221M###
220	± 10	9.0	0.35	8.0	0.31							HVCC153Y6P221K###
330	± 20	10.0	0.39	8.0	0.31							HVCC153Y6P331M###
330	± 10	10.0	0.39	8.0	0.31							HVCC153Y6P331K###
470	± 20	12.0	0.47	8.0	0.31							HVCC153Y6P471M###
470	± 10	12.0	0.47	8.0	0.31							HVCC153Y6P471K###
680	± 20	13.0	0.51	8.0	0.31							HVCC153Y6P681M###
680	± 10	13.0	0.51	9.5	0.37							HVCC153Y6P681K###
1000	± 20	15.0	0.59	8.0	0.31							HVCC153Y6P102M###
1000	± 10	15.0	0.59	9.5	0.37							HVCC153Y6P102K###
1500	± 20	19.0	0.75	8.0	0.31							HVCC153Y6P152M###
1500	± 10	19.0	0.75	8.0	0.31							HVCC153Y6P152K###
2000	± 20	19.0	0.75	8.0	0.31							HVCC153Y6P202M###



ORDERING INFORMATION, 20 kV _{DC}												
C (pF)	TOL. (%)	MAXIMUM DIAMETER		MAXIMUM THICKNESS		LEAD SPACE ± 1 mm (± 0.04")		WIRE SIZE ± 0.05 mm (± 0.002")		LEAD LENGTH ± 5 mm (± 0.2")		ORDERING CODE
		mm	INCH	mm	INCH	mm	INCH	mm	INCH	mm	INCH	
100	± 20	8.0	0.31	9.0	0.35	12.5 and 9.5	0.49 and 0.37	0.80 and 0.65	0.032 and 0.026	30	1.18	HVCC203Y6P101M###
100	± 10	8.0	0.31	9.0	0.35							HVCC203Y6P101K###
150	± 20	8.0	0.31	9.0	0.35							HVCC203Y6P151M###
150	± 10	8.0	0.31	9.0	0.35							HVCC203Y6P151K###
220	± 20	9.0	0.35	9.0	0.35							HVCC203Y6P221M###
220	± 10	9.0	0.35	9.0	0.35							HVCC203Y6P221K###
330	± 20	12.0	0.47	9.0	0.35							HVCC203Y6P331M###
330	± 10	12.0	0.47	9.0	0.35							HVCC203Y6P331K###
470	± 20	13.0	0.51	9.0	0.35							HVCC203Y6P471M###
470	± 10	13.0	0.51	9.0	0.35							HVCC203Y6P471K###
680	± 20	15.0	0.59	9.0	0.35							HVCC203Y6P681M###
680	± 10	15.0	0.59	9.0	0.35							HVCC203Y6P681K###
1000	± 20	17.0	0.67	9.0	0.35							HVCC203Y6P102M###
1000	± 10	17.0	0.67	9.0	0.35							HVCC203Y6P102K###

MARKING					
SAMPLE < 470 pF		SAMPLE < 330 pF		SAMPLE ≥ 470 pF	SAMPLE ≥ 330 pF
10 kV	15 kV	20 kV		10 kV / 15 kV	20 kV
YY - Year WW - Week	YY - Year WW - Week	YY - Year WW - Week		YY - Year WW - Week	YY - Year WW - Week

PN: HVCC153Y6P102MEAX Lot1: 1401838E10 DC1: 1845
 QTY: 170 Lot2: DC2:
 PO: / Batch: 201845CN
 SO: Region: 9520 SL: 0010
 Ser.No: 1845M18555

1/1



ORDERING CODE																
H	V	C	C	1	5	3	Y	6	P	1	0	2	M	E	A	X
1			2		3		4			5		6		7		
1	2	3	4	5	6	7										
SERIES (HIGH VOLTAGE CERAMIC CAPACITOR)	RATED VOLTAGE	TEMPERATURE CHARACTERISTICS	CAPACITANCE VALUE	CAPACITANCE TOLERANCE	1 st DIGIT: LEAD TYPE / LEAD SPACING / GAUGE	2 nd DIGIT: LEAD LENGTH	PACKAGING									

LEAD TYPE (position 6)

STANDARD TYPE						
CODE	LEAD TYPE	LEAD SPACING (mm)	LEAD DIAMETER (mm)	# GAUGE	MATERIAL	LEAD LENGTH (mm)
CA	Straight LL	9.5 ± 1.0	0.65	22	TCCSW	30 ± 5
EA	Straight LL	12.5 ± 1.0	0.80	20	TCCSW	30 ± 5

Notes

- 1th digit: lead type / lead spacing / gauge
- 2nd digit: A = long leads
- LL = long leads
- TCCSW = tinned copper clad steel wire

PACKAGING (position 7)	
CODE	VERSION
X	Bulk

PERFORMANCE			
NO.	PARAMETER	SPECIFICATION	
		TEST CONDITIONS	METHOD AND NOTES
1	Capacitance	Tol. K = ± 10 % at 1000 h Tol. M = ± 20 % at 1000 h	Components are measured with a LCR-meter. Consider aging of ceramic. Given tolerance is valid 1000 h ± 24 h after last heating. Before and after that moment, aging offset has to be considered. (See general information for further instructions)
2	Dissipation factor	DF / tan δ = max. 1.5 %	
3	Insulation resistance	I _R = min. 200 GΩ in 60 s t = 5 s U = 500 V _{DC} ± 10 V _{DC}	NOTE: very high resistances are sensitive to the surrounding area (may lead to unstable measurement values)
4	Dielectric strength (between lead wires)	U ₁ = +1.35 x U _{RDC} /U _{RAC} max. 60 s U ₂ = -1.35 x U _{RDC} /U _{RAC} max. 60 s t _{U1} = t _{U2} = 60 s I _{max.} = 50 mA	1. Apply +1.35 x U _{RDC} /U _{RAC} for max. 60 s 2. Unload part (I _{max.} = 50 mA) 3. Apply -1.35 x U _{RDC} for max. 60 s 4. Unload part (I _{max.} = 50 mA) 5. Avoid current spikes higher than 50 mA
5	Appearance and marking	No visible damage. The marking shall be legible	Visual inspection
6	Dimensions	Dimensions are within specification	Measurement by caliper gauge
7.1	Temperature characteristics / TCC	EIA code = Y6P ΔC/C ₀ = ± 10 % Temp. range = -30 °C to 105 °C	Measurement is done from cooler temperatures to hotter temperatures in reasonable temperature steps. For decreasing temperature run deaging effects must be considered.
7.2	Temperature characteristics / TCDF	DF / tan δ = max. 1.5 % Temp. range = -30 °C to 105 °C	

PERFORMANCE			
NO.	PARAMETER	SPECIFICATION	
		TEST CONDITIONS	METHOD AND NOTES
8	Dielectric strength of body insulation	$U = 5000 V_{DC}$ $t = 60 s$	<ol style="list-style-type: none"> 1. Connect both lead wires together 2. Dip component headfirst into a bath with oil and metal balls (fig.) 3. Apply voltage between lead wires and metal balls
9	Pulse test	$t_r = 1.2 \mu s$ $t_f = 50 \mu s$ $U = 1.25 \times U_{RDC}$ $n = 50 \times \text{single polarity}$	<p> Rise time: $t_r = 1.2 \mu s \pm 30 \%$ Half value time: $t_f = 50 \mu s \pm 20 \%$ Over swing: $\ddot{u} < 5 \%$ </p>
10	Life test	$U = 1.25 \times U_{RDC}$ $t = \text{min. } 1000 h$ $T = \text{max. } 105 \text{ } ^\circ C$ $I_{\text{max.}} = 50 \text{ mA}$	<ol style="list-style-type: none"> 1. Initial measurement including no. 1, 2, 3, and 4 2. Condition the components to test temperature 3. Carry out life test / avoid 0Ω short circuit 4. Final measurement including no. 1, 2, 3, and 4 Result: voltage breakdowns are not accepted
11	Steady state test (without load)	$T = 40 \text{ } ^\circ C$ $RH = 93 \%$ $t = 240 h / 10 \text{ days}$ $U = 1.5 \times U_{RDC}$	<ol style="list-style-type: none"> 1. Initial measurement including no. 1, 2, 3, and 4 2. Carry out steady state test 3. Final measurement including no. 1, 2, 3, and 4 Result: voltage breakdowns are not accepted
12	Temperature cycle	$T_{\text{LOW}} = -30 \text{ } ^\circ C$ $T_{\text{HIGH}} = +105 \text{ } ^\circ C$ $t_{\text{DWELL}} = 1800 s$ $t_{\text{CHANGE}} = \text{about } 300 s$ $n = 50 \times$	<ol style="list-style-type: none"> 1. Initial measurement including no. 1, 2, 3, and 4 2. Carry out temperature cycle 3. Final measurement including no. 1, 2, 3, and 4 Result: voltage breakdowns and cracks in coating are not accepted
13	Solderability	$T_{\text{SOLDER}} = \text{max. } 250 \text{ } ^\circ C$ $t = \text{max. } 3 s$ dist. solder-epoxy = min. 2 mm	<ol style="list-style-type: none"> 1. Initial measurement incl. no. 1, 2, 3, and 4 2. Carry out test (solder material: no known restrictions) 3. Final measurement incl. 1, 2, 3, and 4 Result: voltage breakdowns are not accepted
14	Strength of lead wire / pulling	$F_{\text{PULL}} = \text{max. } 10 N$ $t_{\text{PULL}} = \text{max. } 10 s$	Fix the body of component, apply a tensile weight gradually to each lead wire in the radial direction of capacitor up to 20 N, and keep it for $10 s \pm 1 s$
15	Strength of lead wire / bending	$F_{\text{BEND}} = \text{max. } 5 N$ $t_{\text{BEND}} = 2 s \text{ to } 3 s$	Bending each lead wire to 90° from the lead egress with 2.5 N force, then back to original position and bent again from the same direction. Totally 3 bends, 3 s each time. 1 bend: bending to 90° the return to normal position is one bend. Start from 1.6 mm to 3.2 mm from the part body



TYPICAL TCC Y6P

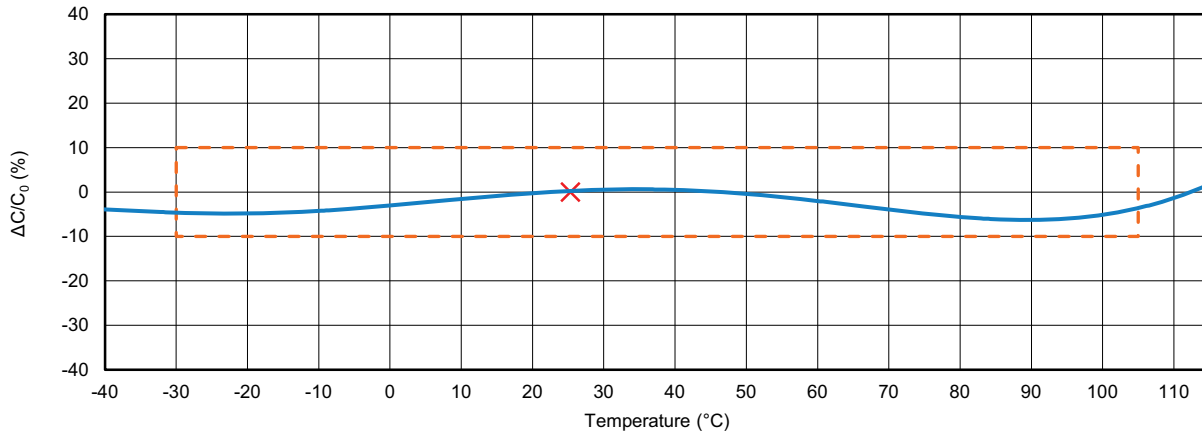

TYPICAL TCDF Y6P

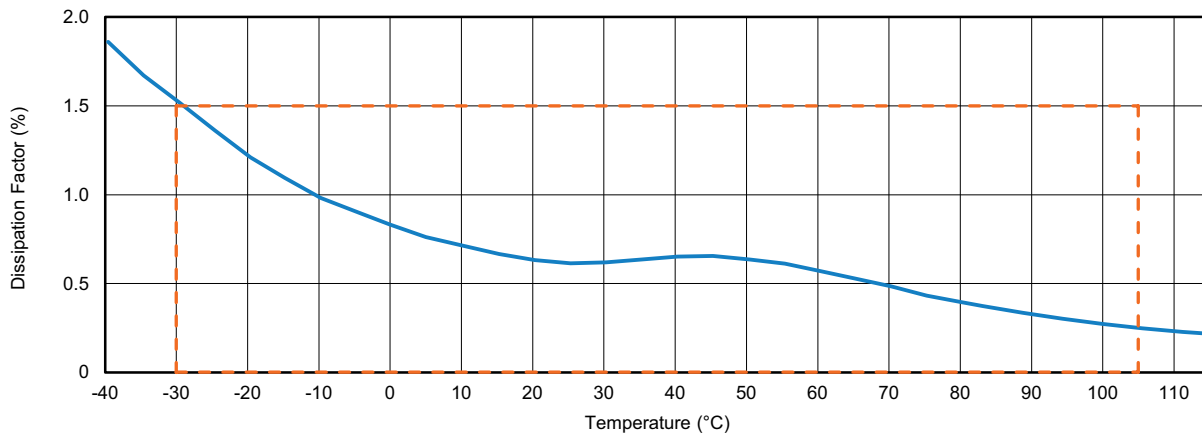

TYPICAL Y6P - $\Delta C/C_0$ / % VS. $U_{rated, DC}$

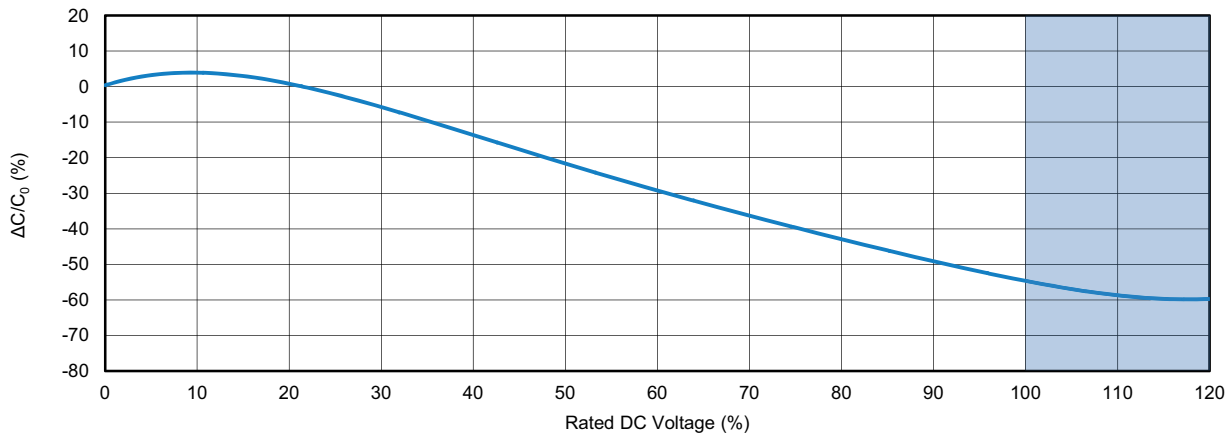



TYPICAL Y6P - $\Delta C/C_0$ / % VS. FREQUENCY

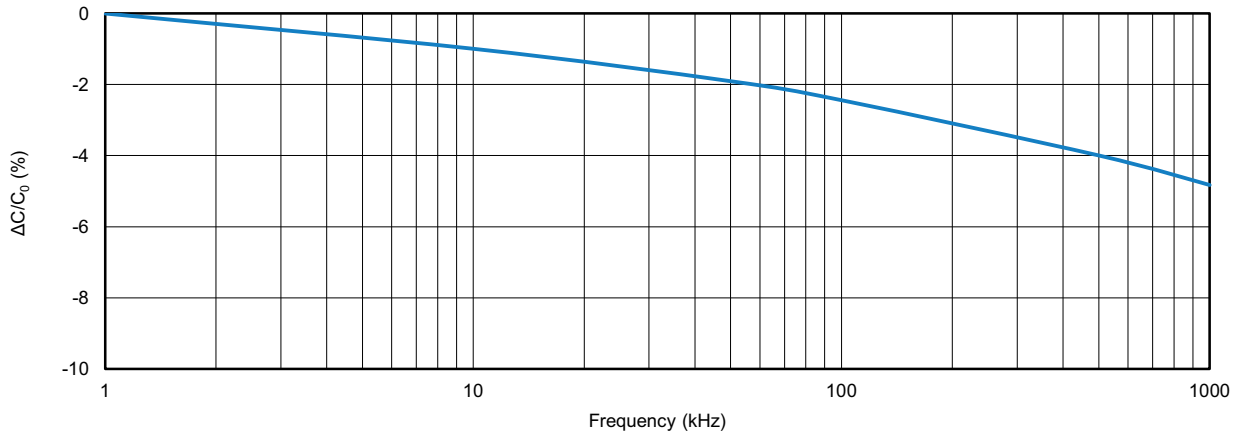

TYPICAL Y6P DF VS. FREQUENCY

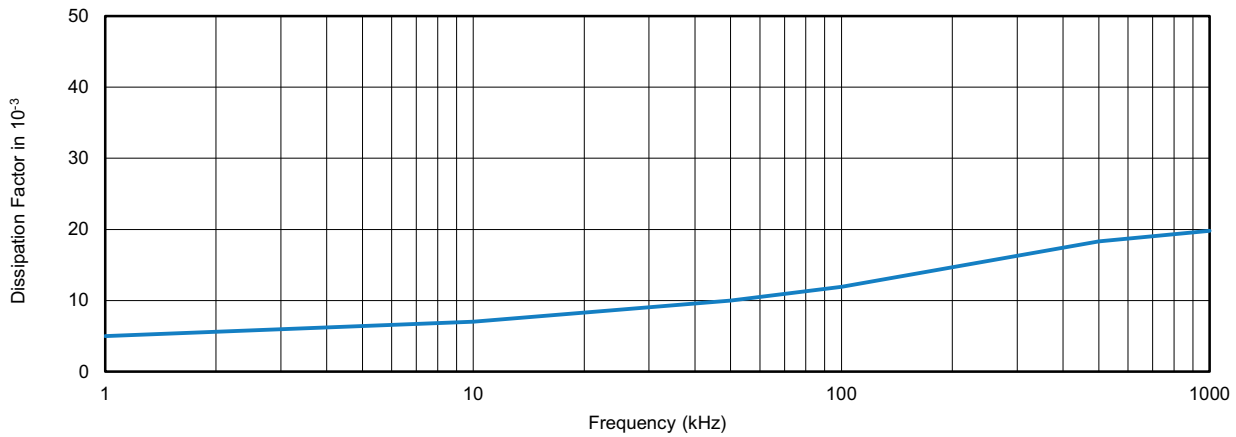

TYPICAL AC CURRENT VS. APPLIED VOLTAGE

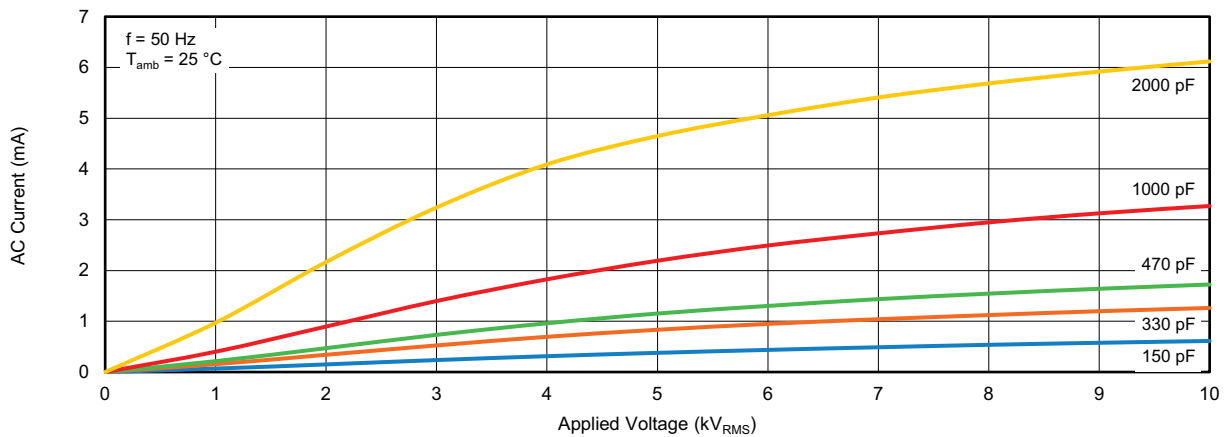



1. QUALIFICATION

1.1 BASICS

All components are tested according to the related testing plan, which you find in series datasheet. The test procedures are more severe than noted in the datasheet due to aging and storage effects of the components. We do not guarantee if any limit is exceeded. Internal test procedures are more severe than noted in the table "Performance" because of aging and storage effects of the components.

1.2 LIMITS OF APPLICATION

Please take care whilst designing our parts into one of these applications, which require highest reliability and possible errors might harm life, body or property of a third party.

- Transportation (aerospace, aircraft, train, ship, submarine, etc.)
- Medical equipment
- Critical control equipment (power plant, traffic signals, disaster prevention)
- Other application requiring similar reliability characteristics

2. STORAGE

2.1 ORIGINAL PACKAGING

Storing in the sealed original packages is preferred.

2.2 STORING CONDITIONS

Epoxy coating does not protect perfectly from all environmental conditions. Some materials can penetrate the epoxy and harm the performance of the parts. Therefore it is not recommended to use or store the parts in corrosive or humid atmosphere.

Optimal storing conditions should not exceed +10 °C to +35 °C and relative humidity up to 60 %.

3. ASSEMBLY

3.1 WIRE FORMING

If wire forming is needed, excessive mechanical force to the component body must be avoided as it might cause cracks in the ceramic element.

Do not crack coating extension of the epoxy layer, when applying force onto the wire.

3.2 SOLDERING

Do not exceed resistance to soldering heat specification of the component. Subjecting this product to excessive heating could melt the internal junction solder and may result in thermal shocks that can crack the ceramic element.

Manual Soldering / Rework

Set the soldering iron (50 W max.) to less than 400 °C and solder the wires within 4 seconds onto the PCB. Exceeding that recommendations might reduce the electrical performance of the component.

Wave Soldering

Most common way to assemble these kind of components is carried out in 4 steps:

1. Increasing temperature to 120 °C within about 20 s
2. Preheating at 120 °C for about 60 s
3. Soldering at 260 °C in less than 10 s
4. Gradual air cooling in constant air flow

Reflow Soldering

It is not recommended to use reflow soldering with these components.

3.3 MOLDING AND COATING

Molding and / or applying another coating material might harm the performance of the components. Therefore it is recommended to test the electrical characteristics of the molded / coated part in advance.

Typical error is a reduced withstand voltage because of an inadequate solvent in the molding material, which penetrates the epoxy coating (please see recommendations for cleaning and drying in section 4.1 to 4.3). A similar result can be caused by an inadequate coating material, which might pull the original epoxy off the ceramic element.



4. CLEANING AND DRYING

4.1 CLEANING AGENTS

Cleaning agents might have an influence to the performance of the components after washing and after unsuitable drying. The following agents have been tested and classified:

Recommended

- DI water
- Isopropanol
- Ethanol
- Ehtyl alcohol
- ...

Not Recommended

- Acetone
- ...

4.2 ULTRASONIC

Settings for ultrasonic cleaning

Rinse bath capacity: output of 20 Watts per liter or less

Rinsing time: 5 min max.

Do not vibrate the PCB / PWB directly.

Excessive ultrasonic cleaning may lead to permanent destruction of the component.

4.3 DRYING

In case of cleaning the assembled PCB with cleaning agents a proper drying is recommended. It is recommended to properly insulate the assembled PCB (see section 5.2) after drying.

5. TESTING AND OPERATION

5.1 SHORT CIRCUIT

Avoid repetitive zero-ohm-short circuits because they might harm the components core construction, such as arcs between lead wires because of inadequate insulation material (e.g air).

5.2 INSULATION

During operation, components should be surrounded by adequate insulating material (silicone oil, epoxy or molding material). Voltage breakdowns or leakage current through this material (between lead wires or to ground) is not acceptable. It is recommended to properly clean and dry the assembled PCB (see section 4.1 to 4.3) before enclosing in insulating material.

5.3 APPLIED VOLTAGE

When using DC-rated components in AC applications (also ripple) the peak to peak voltage should not exceed the nominal DC-rating of the component.

6. CAUTION

6.1 OPERATING VOLTAGE AND FREQUENCY CHARACTERISTIC

When sinusoidal or ripple voltage applied to DC ceramic disc capacitors, be sure to maintain the peak-to-peak value or the peak value of the sum of both AC + DC within the rated voltage.

When start or stop applying the voltage, resonance may generate irregular voltage.

When rectangular or pulse wave voltage is applied to DC ceramic disc capacitors, the self-heating generated by the capacitor is higher than the sinusoidal application with the same frequency. The allowable voltage rating for the rectangular or pulse wave corresponds approximately with the allowable voltage of a sinusoidal wave with the double fundamental frequency.

The allowable voltage varies, depending on the voltage and the waveform.

Diagrams of the limiting values are available for each capacitor series on request.

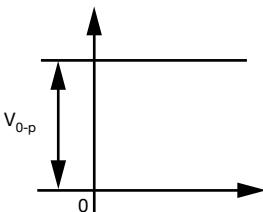
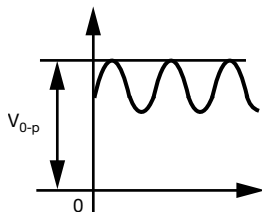
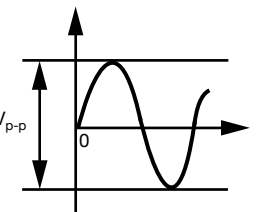
VOLTAGE	DC	DC + AC	AC
Waveform figure			

6.2 OPERATING TEMPERATURE AND SELF-GENERATED HEAT

The surface temperature of the capacitors must not exceed the upper limit of its rated operating temperature.

During operation in a high-frequency circuit or a pulse signal circuit, the capacitor itself generate heat due to dielectric losses. Applied voltage should be the load such as self-generated heat is within 20 °C on the condition of environmental temperature 25 °C.

Note, that excessive heat may lead to deterioration of the capacitor's characteristics.

RELATED DOCUMENTS	
General Information	www.vishay.com/doc?22001
Product Sheet	www.vishay.com/doc?48508
Infographic	www.vishay.com/doc?48450



Disclaimer

ALL PRODUCT, PRODUCT SPECIFICATIONS AND DATA ARE SUBJECT TO CHANGE WITHOUT NOTICE TO IMPROVE RELIABILITY, FUNCTION OR DESIGN OR OTHERWISE.

Vishay Intertechnology, Inc., its affiliates, agents, and employees, and all persons acting on its or their behalf (collectively, "Vishay"), disclaim any and all liability for any errors, inaccuracies or incompleteness contained in any datasheet or in any other disclosure relating to any product.

Vishay makes no warranty, representation or guarantee regarding the suitability of the products for any particular purpose or the continuing production of any product. To the maximum extent permitted by applicable law, Vishay disclaims (i) any and all liability arising out of the application or use of any product, (ii) any and all liability, including without limitation special, consequential or incidental damages, and (iii) any and all implied warranties, including warranties of fitness for particular purpose, non-infringement and merchantability.

Statements regarding the suitability of products for certain types of applications are based on Vishay's knowledge of typical requirements that are often placed on Vishay products in generic applications. Such statements are not binding statements about the suitability of products for a particular application. It is the customer's responsibility to validate that a particular product with the properties described in the product specification is suitable for use in a particular application. Parameters provided in datasheets and / or specifications may vary in different applications and performance may vary over time. All operating parameters, including typical parameters, must be validated for each customer application by the customer's technical experts. Product specifications do not expand or otherwise modify Vishay's terms and conditions of purchase, including but not limited to the warranty expressed therein.

Hyperlinks included in this datasheet may direct users to third-party websites. These links are provided as a convenience and for informational purposes only. Inclusion of these hyperlinks does not constitute an endorsement or an approval by Vishay of any of the products, services or opinions of the corporation, organization or individual associated with the third-party website. Vishay disclaims any and all liability and bears no responsibility for the accuracy, legality or content of the third-party website or for that of subsequent links.

Except as expressly indicated in writing, Vishay products are not designed for use in medical, life-saving, or life-sustaining applications or for any other application in which the failure of the Vishay product could result in personal injury or death. Customers using or selling Vishay products not expressly indicated for use in such applications do so at their own risk. Please contact authorized Vishay personnel to obtain written terms and conditions regarding products designed for such applications.

No license, express or implied, by estoppel or otherwise, to any intellectual property rights is granted by this document or by any conduct of Vishay. Product names and markings noted herein may be trademarks of their respective owners.

单击下面可查看定价，库存，交付和生命周期等信息

[>>Vishay\(威世\)](#)