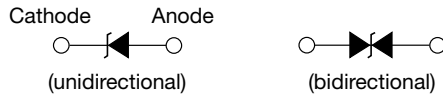

Surface-Mount TRANSZORB® Transient Voltage Suppressors

SMB (DO-214AA)

LINKS TO ADDITIONAL RESOURCES

3D Models

| PRIMARY CHARACTERISTICS | |
|---------------------------------|-------------------------------|
| V_{WM} (unidirectional) | 5.8 V to 459 V |
| V_{WM} (bidirectional) | 5.8 V to 185 V |
| V_{BR} (unidirectional) | 6.8 V to 540 V |
| V_{BR} (bidirectional) | 6.8 V to 220 V |
| P_{PPM} | 600 W |
| P_D | 5.0 W |
| I_{FSM} (unidirectional only) | 100 A |
| T_J max. | 150 °C |
| Polarity | Unidirectional, bidirectional |
| Package | SMB (DO-214AA) |

DEVICES FOR BIDIRECTION APPLICATIONS

For bidirectional devices use CA suffix (e.g. P6SMB10CA). Electrical characteristics apply in both directions.

FEATURES

- Low profile package
- Ideal for automated placement
- Glass passivated chip junction
- Available in unidirectional and bidirectional
- 600 W peak pulse power capability with a 10/1000 μ s waveform, repetitive rate (duty cycle): 0.01 %
- Excellent clamping capability
- Very fast response time
- Low incremental surge resistance
- Meets MSL level 1, per J-STD-020, LF maximum peak of 260 °C
- AEC-Q101 qualified available
 - Automotive ordering code: base P/NHE3 or P/NHM3
- Material categorization: for definitions of compliance please see www.vishay.com/doc?99912

TYPICAL APPLICATIONS

Use in sensitive electronics protection against voltage transients induced by inductive load switching and lighting on ICs, MOSFET, signal lines of sensor units for consumer, computer, industrial, and telecommunication.

MECHANICAL DATA
Case: SMB (DO-214AA)

Molding compound meets UL 94 V-0 flammability rating
 Base P/N-E3 - RoHS-compliant, commercial grade
 Base P/N-M3 - halogen-free, RoHS-compliant, commercial grade
 Base P/NHE3_X - RoHS-compliant and AEC-Q101 qualified
 Base P/NHM3_X - halogen-free, RoHS-compliant, and AEC-Q101 qualified
 (“_X” denotes revision code e.g. A, B, ...)

Terminals: matte tin plated leads, solderable per J-STD-002 and JESD 22-B102

E3, M3, HE3, and HM3 suffix meets JESD 201 class 2 whisker test

Polarity: for unidirectional types the band denotes cathode end, no marking on bidirectional types

| MAXIMUM RATINGS ($T_A = 25$ °C unless otherwise noted) | | | |
|--|----------------|----------------|------|
| PARAMETER | SYMBOL | VALUE | UNIT |
| Peak power dissipation with a 10/1000 μ s waveform ⁽¹⁾⁽²⁾ (fig. 1) | P_{PPM} | 600 | W |
| Peak pulse current with a 10/1000 μ s waveform ⁽¹⁾ | I_{PPM} | See next table | A |
| Power dissipation on infinite heatsink at $T_A = 50$ °C | P_D | 5.0 | W |
| Peak forward surge current 8.3 ms single half sine-wave unidirectional only ⁽²⁾ | I_{FSM} | 100 | A |
| Operating junction and storage temperature range | T_J, T_{STG} | -65 to +150 | °C |

Notes

⁽¹⁾ Non-repetitive current pulse, per fig. 3 and derated above $T_A = 25$ °C per fig. 2

⁽²⁾ Mounted on 0.2" x 0.2" (5.0 mm x 5.0 mm) copper pads to each terminal

**ELECTRICAL CHARACTERISTICS** ($T_A = 25\text{ }^\circ\text{C}$ unless otherwise noted)

| PART NUMBER | DEVICE MARKING CODE | | BREAKDOWN VOLTAGE V_{BR} AT I_T ⁽¹⁾ (V) | | TEST CURRENT I_T (mA) | STAND-OFF VOLTAGE V_{WM} (V) | MAXIMUM REVERSE LEAKAGE AT V_{WM} I_D ⁽³⁾ (μA) | MAXIMUM PEAK PULSE CURRENT I_{PPM} ⁽²⁾ (A) | MAXIMUM CLAMPING VOLTAGE AT I_{PPM} V_C (V) | MAXIMUM TEMPERATURE COEFFICIENT OF V_{BR} ($\%/^\circ\text{C}$) |
|-------------|---------------------|------|--|------|-------------------------|--------------------------------|--|---|---|---|
| | UNI | BI | MIN. | MAX. | | | | | | |
| P6SMB6.8A | 6V8A | 6V8C | 6.45 | 7.14 | 10 | 5.80 | 1000 | 57.1 | 10.5 | 0.057 |
| P6SMB7.5A | 7V5A | 7V5C | 7.13 | 7.88 | 10 | 6.40 | 500 | 53.1 | 11.3 | 0.061 |
| P6SMB8.2A | 8V2A | 8V2C | 7.79 | 8.61 | 10 | 7.02 | 200 | 49.6 | 12.1 | 0.065 |
| P6SMB9.1A | 9V1A | 9V1C | 8.65 | 9.55 | 1.0 | 7.78 | 50 | 44.8 | 13.4 | 0.068 |
| P6SMB10A | 10A | 10C | 9.50 | 10.5 | 1.0 | 8.55 | 10 | 41.4 | 14.5 | 0.073 |
| P6SMB11A | 11A | 11C | 10.5 | 11.6 | 1.0 | 9.40 | 5.0 | 38.5 | 15.6 | 0.075 |
| P6SMB12A | 12A | 12C | 11.4 | 12.6 | 1.0 | 10.2 | 5.0 | 35.9 | 16.7 | 0.078 |
| P6SMB13A | 13A | 13C | 12.4 | 13.7 | 1.0 | 11.1 | 5.0 | 33.0 | 18.2 | 0.081 |
| P6SMB15A | 15A | 15C | 14.3 | 15.8 | 1.0 | 12.8 | 1.0 | 28.3 | 21.2 | 0.084 |
| P6SMB16A | 16A | 16C | 15.2 | 16.8 | 1.0 | 13.6 | 1.0 | 26.7 | 22.5 | 0.086 |
| P6SMB18A | 18A | 18C | 17.1 | 18.9 | 1.0 | 15.3 | 1.0 | 23.8 | 25.2 | 0.088 |
| P6SMB20A | 20A | 20C | 19.0 | 21.0 | 1.0 | 17.1 | 1.0 | 21.7 | 27.7 | 0.090 |
| P6SMB22A | 22A | 22C | 20.9 | 23.1 | 1.0 | 18.8 | 1.0 | 19.6 | 30.6 | 0.092 |
| P6SMB24A | 24A | 24C | 22.8 | 25.2 | 1.0 | 20.5 | 1.0 | 18.1 | 33.2 | 0.094 |
| P6SMB27A | 27A | 27C | 25.7 | 28.4 | 1.0 | 23.1 | 1.0 | 16.0 | 37.5 | 0.096 |
| P6SMB30A | 30A | 30C | 28.5 | 31.5 | 1.0 | 25.6 | 1.0 | 14.5 | 41.4 | 0.097 |
| P6SMB33A | 33A | 33C | 31.4 | 34.7 | 1.0 | 28.2 | 1.0 | 13.1 | 45.7 | 0.098 |
| P6SMB36A | 36A | 36C | 34.2 | 37.8 | 1.0 | 30.8 | 1.0 | 12.0 | 49.9 | 0.099 |
| P6SMB39A | 39A | 39C | 37.1 | 41.0 | 1.0 | 33.3 | 1.0 | 11.1 | 53.9 | 0.100 |
| P6SMB43A | 43A | 43C | 40.9 | 45.2 | 1.0 | 36.8 | 1.0 | 10.1 | 59.3 | 0.101 |
| P6SMB47A | 47A | 47C | 44.7 | 49.4 | 1.0 | 40.2 | 1.0 | 9.3 | 64.8 | 0.101 |
| P6SMB51A | 51A | 51C | 48.5 | 53.6 | 1.0 | 43.6 | 1.0 | 8.6 | 70.1 | 0.102 |
| P6SMB56A | 56A | 56C | 53.2 | 58.8 | 1.0 | 47.8 | 1.0 | 7.8 | 77.0 | 0.103 |
| P6SMB62A | 62A | 62C | 58.9 | 65.1 | 1.0 | 53.0 | 1.0 | 7.1 | 85.0 | 0.104 |
| P6SMB68A | 68A | 68C | 64.6 | 71.4 | 1.0 | 58.1 | 1.0 | 6.5 | 92.0 | 0.104 |
| P6SMB75A | 75A | 75C | 71.3 | 78.8 | 1.0 | 64.1 | 1.0 | 5.8 | 103 | 0.105 |
| P6SMB82A | 82A | 82C | 77.9 | 86.1 | 1.0 | 70.1 | 1.0 | 5.3 | 113 | 0.105 |
| P6SMB91A | 91A | 91C | 86.5 | 95.5 | 1.0 | 77.8 | 1.0 | 4.8 | 125 | 0.106 |
| P6SMB100A | 100A | 100C | 95.0 | 105 | 1.0 | 85.5 | 1.0 | 4.4 | 137 | 0.106 |
| P6SMB110A | 110A | 110C | 105 | 116 | 1.0 | 94.0 | 1.0 | 3.9 | 152 | 0.107 |
| P6SMB120A | 120A | 120C | 114 | 126 | 1.0 | 102 | 1.0 | 3.6 | 165 | 0.107 |
| P6SMB130A | 130A | 130C | 124 | 137 | 1.0 | 111 | 1.0 | 3.4 | 179 | 0.107 |
| P6SMB150A | 150A | 150C | 143 | 158 | 1.0 | 128 | 1.0 | 2.9 | 207 | 0.108 |
| P6SMB160A | 160A | 160C | 152 | 168 | 1.0 | 136 | 1.0 | 2.7 | 219 | 0.108 |
| P6SMB170A | 170A | 170C | 162 | 179 | 1.0 | 145 | 1.0 | 2.6 | 234 | 0.108 |
| P6SMB180A | 180A | 180C | 171 | 189 | 1.0 | 154 | 1.0 | 2.4 | 246 | 0.108 |
| P6SMB200A | 200A | 200C | 190 | 210 | 1.0 | 171 | 1.0 | 2.2 | 274 | 0.108 |
| P6SMB220A | 220A | 220C | 209 | 231 | 1.0 | 185 | 1.0 | 1.8 | 328 | 0.108 |
| P6SMB250A | 250A | - | 237 | 263 | 1.0 | 214 | 1.0 | 1.74 | 344 | 0.110 |
| P6SMB300A | 300A | - | 285 | 315 | 1.0 | 256 | 1.0 | 1.45 | 414 | 0.110 |
| P6SMB350A | 350A | - | 333 | 368 | 1.0 | 300 | 1.0 | 1.24 | 482 | 0.110 |
| P6SMB400A | 400A | - | 380 | 420 | 1.0 | 342 | 1.0 | 1.10 | 548 | 0.110 |
| P6SMB440A | 440A | - | 418 | 462 | 1.0 | 376 | 1.0 | 1.00 | 602 | 0.110 |
| P6SMB480A | 480A | - | 456 | 504 | 1.0 | 408 | 1.0 | 0.91 | 658 | 0.110 |
| P6SMB510A | 510A | - | 485 | 535 | 1.0 | 434 | 1.0 | 0.86 | 698 | 0.110 |
| P6SMB540A | 540A | - | 513 | 567 | 1.0 | 459 | 1.0 | 0.81 | 740 | 0.110 |

Notes

- (1) Pulse test: $t_p \leq 50\text{ ms}$
(2) Surge current waveform per fig. 3 and derate per fig. 2
(3) For bi-directional types with V_{WM} of 10 V and less, the I_D limit is doubled
(4) All terms and symbols are consistent with ANSI/IEEE CA62.35
(5) $V_F = 3.5\text{ V}$ at $I_F = 50\text{ A}$ (unidirectional only)

**THERMAL CHARACTERISTICS** ($T_A = 25\text{ }^\circ\text{C}$ unless otherwise noted)

| PARAMETER | SYMBOL | VALUE | UNIT |
|--|-----------------|-------|------|
| Typical thermal resistance, junction to ambient air ⁽¹⁾ | $R_{\theta JA}$ | 100 | °C/W |
| Typical thermal resistance, junction to lead | $R_{\theta JL}$ | 20 | |

Note

⁽¹⁾ Mounted on minimum recommended pad layout

ORDERING INFORMATION (Example)

| PREFERRED P/N | UNIT WEIGHT (g) | VOLTAGE RANGE (V) | | PACKAGE CODE | BASE QUANTITY | DELIVERY MODE |
|---------------------------------|-----------------|-------------------|------------|--------------|---------------|------------------------------------|
| | | UNI | BI | | | |
| P6SMB6.8A-E3/52 | 0.096 | 6.8 to 220 | 6.8 to 220 | 52 | 750 | 7" diameter plastic tape and reel |
| P6SMB6.8A-M3/52 | 0.096 | 6.8 to 540 | 6.8 to 220 | 52 | 750 | 7" diameter plastic tape and reel |
| P6SMB6.8A-E3/5B | 0.096 | 6.8 to 220 | 6.8 to 220 | 5B | 3200 | 13" diameter plastic tape and reel |
| P6SMB6.8A-M3/5B | 0.096 | 6.8 to 540 | 6.8 to 220 | 5B | 3200 | 13" diameter plastic tape and reel |
| P6SMB6.8AHE3_A/H ⁽¹⁾ | 0.096 | 6.8 to 220 | 6.8 to 220 | H | 750 | 7" diameter plastic tape and reel |
| P6SMB6.8AHM3_A/H ⁽¹⁾ | | | | | | |
| P6SMB6.8AHE3_A/I ⁽¹⁾ | 0.096 | 6.8 to 220 | 6.8 to 220 | I | 3200 | 13" diameter plastic tape and reel |
| P6SMB6.8AHM3_A/I ⁽¹⁾ | | | | | | |
| P6SMB250AHM3_C/H ⁽²⁾ | 0.096 | 250 to 540 | - | H | 750 | 7" diameter plastic tape and reel |
| P6SMB250AHM3_C/I ⁽²⁾ | 0.096 | 250 to 540 | - | I | 3200 | 13" diameter plastic tape and reel |

Notes

⁽¹⁾ _A is available for P6SMB6.8(C)A to P6SMB220(C)A, AEC-Q101 qualified

⁽²⁾ _C is available for P6SMB250A to P6SMB540A, AEC-Q101 qualified

RATINGS AND CHARACTERISTICS CURVES ($T_A = 25\text{ }^\circ\text{C}$ unless otherwise noted)

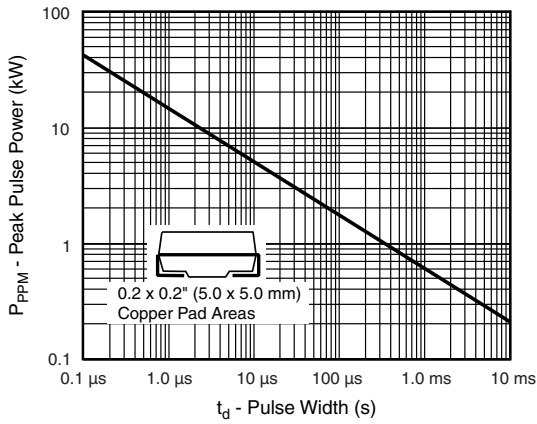

Fig. 1 - Peak Pulse Power Rating Curve

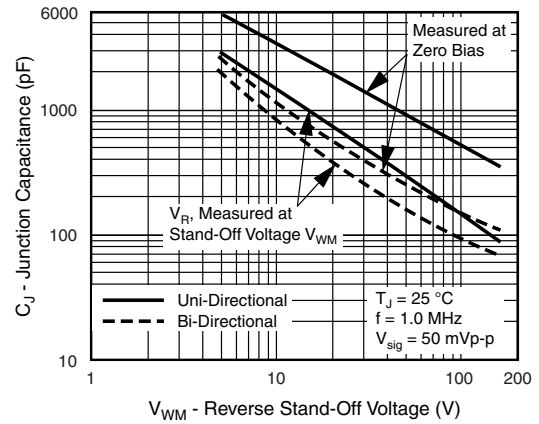

Fig. 4 - Typical Junction Capacitance

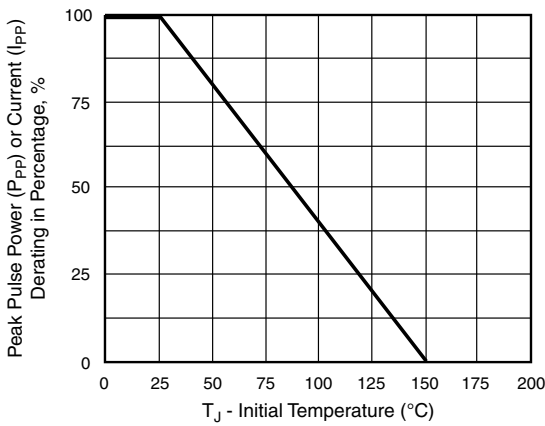

Fig. 2 - Pulse Power or Current vs. Initial Junction Temperature

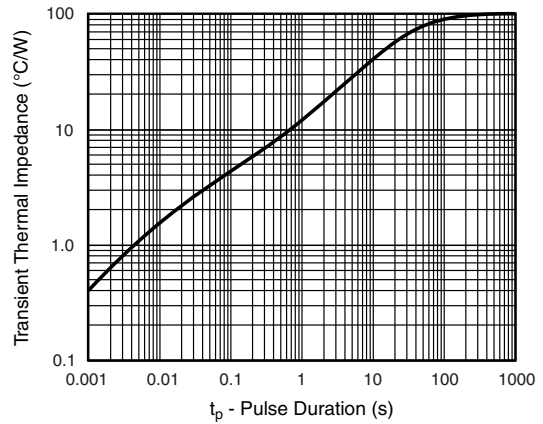

Fig. 5 - Typical Transient Thermal Impedance

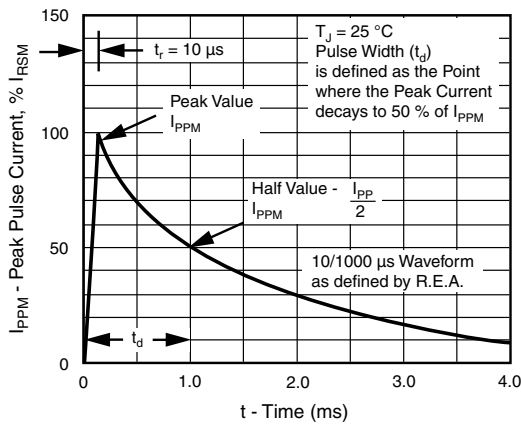

Fig. 3 - Pulse Waveform

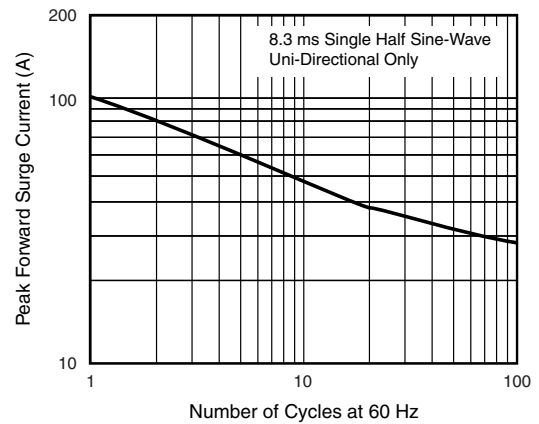
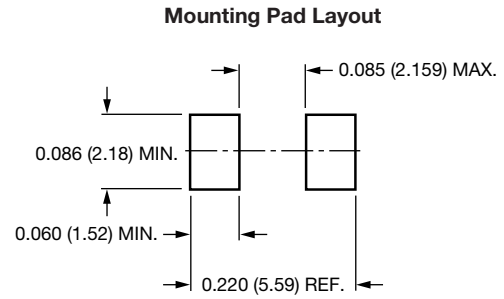
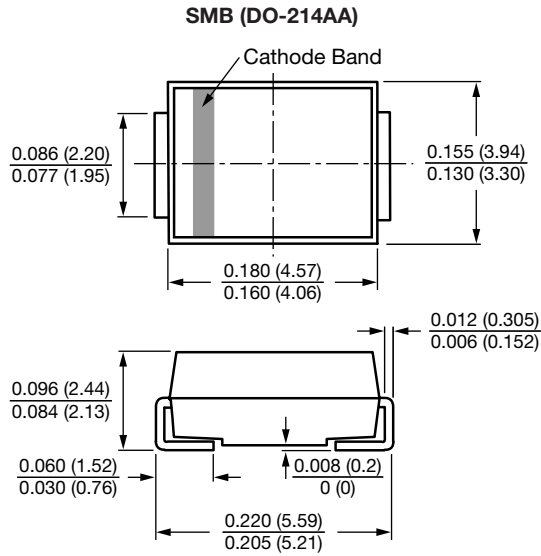

Fig. 6 - Maximum Non-Repetitive Peak Forward Surge Current



PACKAGE OUTLINE DIMENSIONS in inches (millimeters)





Disclaimer

ALL PRODUCT, PRODUCT SPECIFICATIONS AND DATA ARE SUBJECT TO CHANGE WITHOUT NOTICE TO IMPROVE RELIABILITY, FUNCTION OR DESIGN OR OTHERWISE.

Vishay Intertechnology, Inc., its affiliates, agents, and employees, and all persons acting on its or their behalf (collectively, "Vishay"), disclaim any and all liability for any errors, inaccuracies or incompleteness contained in any datasheet or in any other disclosure relating to any product.

Vishay makes no warranty, representation or guarantee regarding the suitability of the products for any particular purpose or the continuing production of any product. To the maximum extent permitted by applicable law, Vishay disclaims (i) any and all liability arising out of the application or use of any product, (ii) any and all liability, including without limitation special, consequential or incidental damages, and (iii) any and all implied warranties, including warranties of fitness for particular purpose, non-infringement and merchantability.

Statements regarding the suitability of products for certain types of applications are based on Vishay's knowledge of typical requirements that are often placed on Vishay products in generic applications. Such statements are not binding statements about the suitability of products for a particular application. It is the customer's responsibility to validate that a particular product with the properties described in the product specification is suitable for use in a particular application. Parameters provided in datasheets and / or specifications may vary in different applications and performance may vary over time. All operating parameters, including typical parameters, must be validated for each customer application by the customer's technical experts. Product specifications do not expand or otherwise modify Vishay's terms and conditions of purchase, including but not limited to the warranty expressed therein.

Hyperlinks included in this datasheet may direct users to third-party websites. These links are provided as a convenience and for informational purposes only. Inclusion of these hyperlinks does not constitute an endorsement or an approval by Vishay of any of the products, services or opinions of the corporation, organization or individual associated with the third-party website. Vishay disclaims any and all liability and bears no responsibility for the accuracy, legality or content of the third-party website or for that of subsequent links.

Except as expressly indicated in writing, Vishay products are not designed for use in medical, life-saving, or life-sustaining applications or for any other application in which the failure of the Vishay product could result in personal injury or death. Customers using or selling Vishay products not expressly indicated for use in such applications do so at their own risk. Please contact authorized Vishay personnel to obtain written terms and conditions regarding products designed for such applications.

No license, express or implied, by estoppel or otherwise, to any intellectual property rights is granted by this document or by any conduct of Vishay. Product names and markings noted herein may be trademarks of their respective owners.

单击下面可查看定价，库存，交付和生命周期等信息

[>>Vishay\(威世\)](#)