

Surface Mount TRANSZORB® Transient Voltage Suppressors

eSMP® Series

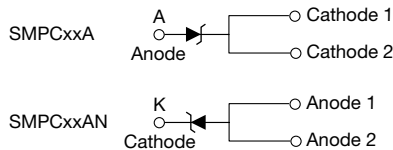

SMPC (TO-277A)



LINKS TO ADDITIONAL RESOURCES



| PRIMARY CHARACTERISTICS | |
|---|----------------------|
| V_{BR} unidirectional | 6.40 V to 104 V |
| V_{WM} | 5.0 V to 85 V |
| P_{PPM} | 1500 W |
| P_D at $T_A = 25\text{ }^\circ\text{C}$ | 1.25 W |
| T_J max. | 150 $^\circ\text{C}$ |
| Polarity | Unidirectional |
| Package | SMPC (TO-277A) |

Note

- All electrical characteristics are only applicable when two identical polarity terminals are connected

| MAXIMUM RATINGS ($T_A = 25\text{ }^\circ\text{C}$ unless otherwise noted) | | | |
|--|-----------------|----------------|------------------|
| PARAMETER | SYMBOL | VALUE | UNIT |
| Peak power dissipation with a 10/1000 μs waveform (fig. 3) | $P_{PPM}^{(1)}$ | 1500 | W |
| Peak pulse current with a 10/1000 μs waveform (fig. 1) | $I_{PPM}^{(1)}$ | See next table | A |
| Power dissipation, $T_A = 25\text{ }^\circ\text{C}$ | $P_D^{(2)}$ | 1.25 | W |
| Operating junction and storage temperature range | T_J, T_{STG} | -55 to +150 | $^\circ\text{C}$ |

Note

- (1) Non-repetitive current pulse, per fig. 3 and derated above $T_A = 25\text{ }^\circ\text{C}$ per fig. 2
 (2) Power dissipation mounted on FR4 PCB, 2 oz. standard footprint

FEATURES

- Very low profile - typical height of 1.1 mm
- Ideal for automated placement
- Unidirection
- Excellent clamping capability
- Low incremental surge resistance
- Very fast response time
- Meets MSL level 1, per J-STD-020, LF maximum peak of 260 $^\circ\text{C}$
- AEC-Q101 qualified available
- Automotive ordering code: base P/NHM3
- Material categorization: for definitions of compliance please see www.vishay.com/doc?99912



TYPICAL APPLICATIONS

Use in sensitive electronics protection against voltage transients induced by inductive load switching and lighting on ICs, MOSFET, signal lines of sensor units for consumer, computer, industrial and telecommunication. Sensitive equipment against transient overvoltages.

MECHANICAL DATA

Case: SMPC (TO-277A)

Molding compound meets UL 94 V-0 flammability rating
 Base P/N-M3 - halogen-free, RoHS-compliant, and industrial grade

Base P/NHM3 - halogen-free, RoHS-compliant, and AEC-Q101 qualified

Terminals: matte tin plated leads, solderable per J-STD-002 and JESD 22-B102

M3 and HM3 suffix meet JESD 201 class 2 whisker test

Polarity: the band denotes cathode end



SMPC5.0A thru SMPC36A, SMPC22AN thru SMPC85AN

www.vishay.com

Vishay General Semiconductor

| ELECTRICAL CHARACTERISTICS (T _A = 25 °C unless otherwise noted) | | | | | | | | | | |
|--|---------------------|---------------------|-----------|--|------|----------------------------------|---------------------------------------|--|--|---|
| DEVICE TYPE | | DEVICE MARKING CODE | | BREAKDOWN VOLTAGE V _{BR} AT I _T ⁽¹⁾ (V) | | TEST CURRENT I _T (mA) | STAND-OFF VOLTAGE V _{WM} (V) | MAXIMUM REVERSE LEAKAGE CURRENT I _R AT V _{WM} (μA) | MAXIMUM PEAK PULSE SURGE CURRENT I _{PPM} ⁽²⁾ (A) | MAXIMUM CLAMPING VOLTAGE AT I _{PPM} V _C (V) |
| ANODE ON HEATSINK | CATHODE ON HEATSINK | SUFFIX A | SUFFIX AN | MIN. | MAX. | | | | | |
| SMPC5.0A | - | GDE | - | 6.40 | 7.07 | 10 | 5.0 | 1500 | 150.0 | 10.0 |
| SMPC6.0A | - | GDG | - | 6.67 | 7.37 | 10 | 6.0 | 1000 | 145.6 | 10.3 |
| SMPC6.5A | - | GDK | - | 7.22 | 7.98 | 10 | 6.5 | 500 | 133.9 | 11.2 |
| SMPC7.0A | - | GDM | - | 7.78 | 8.60 | 10 | 7.0 | 200 | 125.0 | 12.0 |
| SMPC7.5A | - | GDP | - | 8.33 | 9.21 | 1.0 | 7.5 | 100 | 116.3 | 12.9 |
| SMPC8.0A | - | GDR | - | 8.89 | 9.83 | 1.0 | 8.0 | 50 | 110.3 | 13.6 |
| SMPC8.5A | - | GDT | - | 9.44 | 10.4 | 1.0 | 8.5 | 20 | 104.2 | 14.4 |
| SMPC9.0A | - | GDV | - | 10.0 | 11.1 | 1.0 | 9.0 | 5.0 | 97.4 | 15.4 |
| SMPC10A | - | GDY | - | 11.1 | 12.3 | 1.0 | 10.0 | 2.0 | 88.2 | 17.0 |
| SMPC11A | - | GDZ | - | 12.2 | 13.5 | 1.0 | 11.0 | 2.0 | 82.4 | 18.2 |
| SMPC12A | - | GEE | - | 13.3 | 14.7 | 1.0 | 12.0 | 2.0 | 75.4 | 19.9 |
| SMPC13A | - | GEG | - | 14.4 | 15.9 | 1.0 | 13.0 | 1.0 | 69.8 | 21.5 |
| SMPC14A | - | GEK | - | 15.6 | 17.2 | 1.0 | 14.0 | 1.0 | 64.7 | 23.2 |
| SMPC15A | - | GEM | - | 16.7 | 18.5 | 1.0 | 15.0 | 1.0 | 61.5 | 24.4 |
| SMPC16A | - | GEP | - | 17.8 | 19.7 | 1.0 | 16.0 | 1.0 | 57.7 | 26.0 |
| SMPC17A | - | GER | - | 18.9 | 20.9 | 1.0 | 17.0 | 1.0 | 54.3 | 27.6 |
| SMPC18A | - | GET | - | 20.0 | 22.1 | 1.0 | 18.0 | 1.0 | 51.4 | 29.2 |
| SMPC20A | - | GEV | - | 22.2 | 24.5 | 1.0 | 20.0 | 1.0 | 46.3 | 32.4 |
| SMPC22A | SMPC22AN | GEX | PAV | 24.4 | 26.9 | 1.0 | 22.0 | 1.0 | 42.3 | 35.5 |
| SMPC24A | SMPC24AN | GEZ | PAW | 26.7 | 29.5 | 1.0 | 24.0 | 1.0 | 38.6 | 38.9 |
| SMPC26A | SMPC26AN | GFE | PAX | 28.9 | 31.9 | 1.0 | 26.0 | 1.0 | 35.6 | 42.1 |
| SMPC28A | SMPC28AN | GFG | PAY | 31.1 | 34.4 | 1.0 | 28.0 | 1.0 | 33.0 | 45.4 |
| SMPC30A | SMPC30AN | GFK | PAZ | 33.3 | 36.8 | 1.0 | 30.0 | 1.0 | 31.0 | 48.4 |
| SMPC33A | SMPC33AN | GFM | PBA | 36.7 | 40.6 | 1.0 | 33.0 | 1.0 | 28.1 | 53.3 |
| SMPC36A | SMPC36AN | GFP | PBB | 40.0 | 44.2 | 1.0 | 36.0 | 1.0 | 25.8 | 58.1 |
| - | SMPC40AN | - | PBC | 44.4 | 49.1 | 1.0 | 40.0 | 1.0 | 23.3 | 64.5 |
| - | SMPC43AN | - | PBD | 47.8 | 52.8 | 1.0 | 43.0 | 1.0 | 21.6 | 69.4 |
| - | SMPC45AN | - | PBE | 50.0 | 55.3 | 1.0 | 45.0 | 1.0 | 20.6 | 72.7 |
| - | SMPC48AN | - | PBF | 53.3 | 58.9 | 1.0 | 48.0 | 1.0 | 19.4 | 77.4 |
| - | SMPC51AN | - | PBG | 56.7 | 62.7 | 1.0 | 51.0 | 1.0 | 18.2 | 82.4 |
| - | SMPC54AN | - | PBH | 60.0 | 66.3 | 1.0 | 54.0 | 1.0 | 17.2 | 87.1 |
| - | SMPC58AN | - | PBK | 64.4 | 71.2 | 1.0 | 58.0 | 1.0 | 16.0 | 93.6 |
| - | SMPC60AN | - | PBL | 66.7 | 73.7 | 1.0 | 60.0 | 1.0 | 15.5 | 96.8 |
| - | SMPC64AN | - | PBM | 71.1 | 78.6 | 1.0 | 64.0 | 1.0 | 14.6 | 103 |
| - | SMPC70AN | - | PBN | 77.8 | 86.0 | 1.0 | 70.0 | 1.0 | 13.3 | 113 |
| - | SMPC75AN | - | PBP | 83.3 | 92.1 | 1.0 | 75.0 | 1.0 | 12.4 | 121 |
| - | SMPC78AN | - | PBQ | 86.7 | 95.8 | 1.0 | 78.0 | 1.0 | 11.9 | 126 |
| - | SMPC85AN | - | PBR | 94.4 | 104 | 1.0 | 85.0 | 1.0 | 10.9 | 137 |

Notes

- (1) Pulse test: t ≤ 50 ms
- (2) Surge current waveform per fig. 3 and derated per fig. 2
- (3) All terms and symbols are consistent with ANSI/IEEE C62.35



| THERMAL CHARACTERISTICS ($T_A = 25\text{ }^\circ\text{C}$ unless otherwise noted) | | | | |
|---|--------------------------------|------|------|--------------------|
| PARAMETER | SYMBOL | TYP. | MAX. | UNIT |
| Typical thermal resistance | $R_{\theta JA}$ ⁽¹⁾ | 85 | 100 | $^\circ\text{C/W}$ |
| | $R_{\theta JM}$ ⁽²⁾ | 2.5 | 3 | |

Notes

- (1) Thermal resistance junction-to-ambient to follow JEDEC[®] 51-2A, device mounted on FR4 PCB, 2 oz. standard footprint
- (2) Thermal resistance junction-to-mount to follow JEDEC[®] 51-14 using Transient Dual Interface Test Method (TDIM)

| ORDERING INFORMATION (Example) | | | | |
|---------------------------------------|-----------------|------------------------|---------------|------------------------------------|
| PREFERRED P/N | UNIT WEIGHT (g) | PREFERRED PACKAGE CODE | BASE QUANTITY | DELIVERY MODE |
| SMPC5.0A-M3/86A ⁽¹⁾ | 0.10 | 86A | 1500 | 7" diameter plastic tape and reel |
| SMPC5.0A-M3/87A ⁽¹⁾ | 0.10 | 87A | 6500 | 13" diameter plastic tape and reel |
| SMPC22AN-M3/H | 0.10 | H | 1500 | 7" diameter plastic tape and reel |
| SMPC22AN-M3/I | 0.10 | I | 6500 | 13" diameter plastic tape and reel |
| SMPC22ANHM3/H ⁽²⁾ | 0.10 | H | 1500 | 7" diameter plastic tape and reel |
| SMPC22ANHM3/I ⁽²⁾ | 0.10 | I | 6500 | 13" diameter plastic tape and reel |

Notes

- (1) Package code /86A and /87A are available for SMPC5.0A-M3 to SMPC36A-M3
- (2) AEC-Q101 qualified, is available for SMPC22AN to SMPC85AN only



RATINGS AND CHARACTERISTICS CURVES ($T_A = 25\text{ }^\circ\text{C}$ unless otherwise noted)

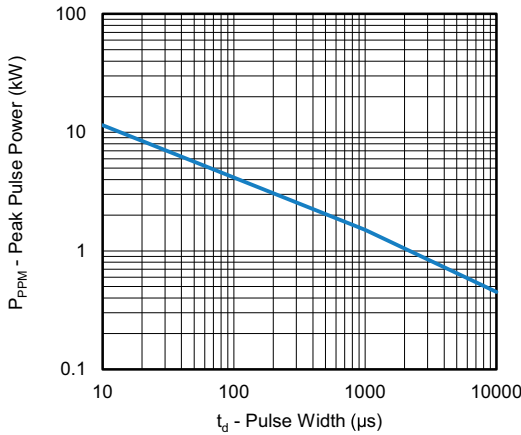

Fig. 1 - Peak Pulse Power Rating Curve

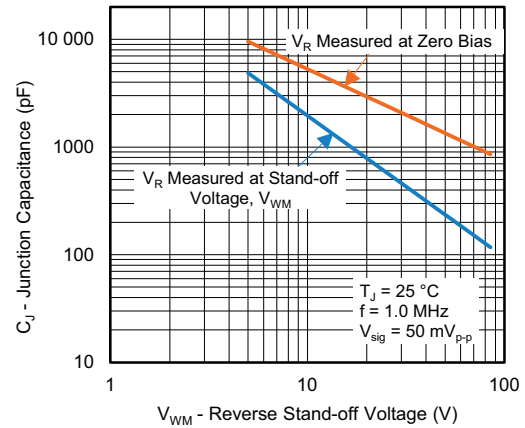

Fig. 3 - Typical Junction Capacitance

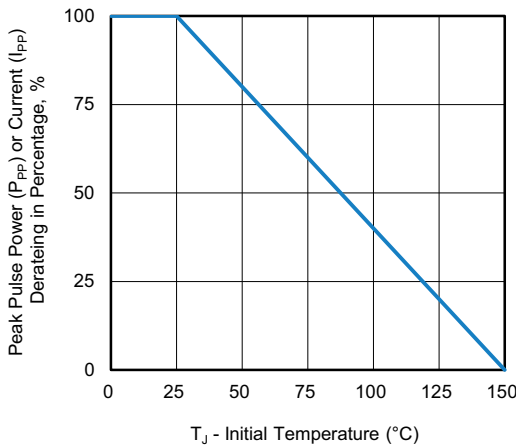

Fig. 2 - Pulse Power or Current vs. Initial Junction Temperature

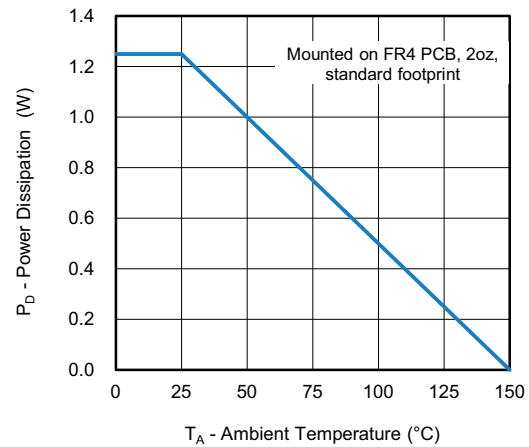

Fig. 4 - Steady State Power Dissipation

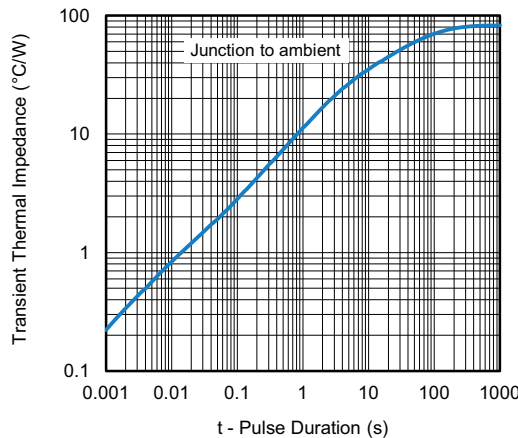

Fig. 5 - Typical Transient Thermal Impedance

Note

- Fig. 1 - Power calculation is based on I_{PPM} times defined maximum clamping voltage by pulse width
- Fig. 1 - 10 000 μs P_{PPM} is actual tested for $V_{WM} \leq 60\text{ V}$ types, over 60 V types 10 000 μs P_{PPM} is curve extensional value



PACKAGE OUTLINE DIMENSIONS in inches (millimeters)

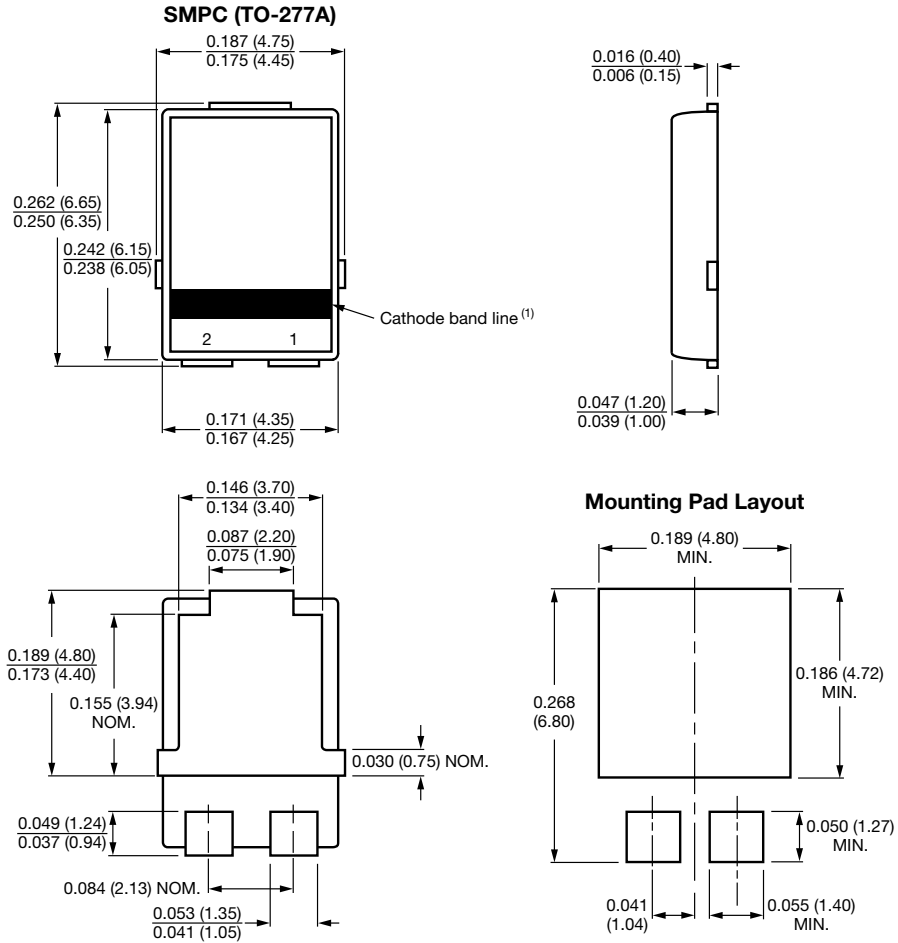

Conform to JEDEC® TO-277A

Note

(1) Cathode band orientation depends on device actual polarity direction



Disclaimer

ALL PRODUCT, PRODUCT SPECIFICATIONS AND DATA ARE SUBJECT TO CHANGE WITHOUT NOTICE TO IMPROVE RELIABILITY, FUNCTION OR DESIGN OR OTHERWISE.

Vishay Intertechnology, Inc., its affiliates, agents, and employees, and all persons acting on its or their behalf (collectively, "Vishay"), disclaim any and all liability for any errors, inaccuracies or incompleteness contained in any datasheet or in any other disclosure relating to any product.

Vishay makes no warranty, representation or guarantee regarding the suitability of the products for any particular purpose or the continuing production of any product. To the maximum extent permitted by applicable law, Vishay disclaims (i) any and all liability arising out of the application or use of any product, (ii) any and all liability, including without limitation special, consequential or incidental damages, and (iii) any and all implied warranties, including warranties of fitness for particular purpose, non-infringement and merchantability.

Statements regarding the suitability of products for certain types of applications are based on Vishay's knowledge of typical requirements that are often placed on Vishay products in generic applications. Such statements are not binding statements about the suitability of products for a particular application. It is the customer's responsibility to validate that a particular product with the properties described in the product specification is suitable for use in a particular application. Parameters provided in datasheets and / or specifications may vary in different applications and performance may vary over time. All operating parameters, including typical parameters, must be validated for each customer application by the customer's technical experts. Product specifications do not expand or otherwise modify Vishay's terms and conditions of purchase, including but not limited to the warranty expressed therein.

Hyperlinks included in this datasheet may direct users to third-party websites. These links are provided as a convenience and for informational purposes only. Inclusion of these hyperlinks does not constitute an endorsement or an approval by Vishay of any of the products, services or opinions of the corporation, organization or individual associated with the third-party website. Vishay disclaims any and all liability and bears no responsibility for the accuracy, legality or content of the third-party website or for that of subsequent links.

Except as expressly indicated in writing, Vishay products are not designed for use in medical, life-saving, or life-sustaining applications or for any other application in which the failure of the Vishay product could result in personal injury or death. Customers using or selling Vishay products not expressly indicated for use in such applications do so at their own risk. Please contact authorized Vishay personnel to obtain written terms and conditions regarding products designed for such applications.

No license, express or implied, by estoppel or otherwise, to any intellectual property rights is granted by this document or by any conduct of Vishay. Product names and markings noted herein may be trademarks of their respective owners.