



IR Receiver Modules for Remote Control Systems



FEATURES

- Very low supply current
- Photo detector and preamplifier in one package
- Internal filter for PCM frequency
- Supply voltage: 2.5 V to 5.5 V
- Improved immunity against ambient light
- Insensitive to supply voltage ripple and noise
- Material categorization:
for definitions of compliance please see www.vishay.com/doc?99912



LINKS TO ADDITIONAL RESOURCES



DESCRIPTION

These products are miniaturized IR receiver modules for infrared remote control systems. A PIN diode and a preamplifier are assembled on a leadframe, the epoxy package contains an IR filter.

The demodulated output signal can be directly connected to a microprocessor for decoding.

The TSOP384.. series devices are optimized to suppress almost all spurious pulses from energy saving lamps like CFLs. The AGC4 used in the TSOP384.. may suppress some data signals. The TSOP382.. series are provided primarily for compatibility with old AGC2 designs. New designs should prefer the TSOP384.. series containing the newer AGC4.

These components have not been qualified according to automotive specifications.

MECHANICAL DATA

Pinning for TSOP382.., TSOP384..:

1 = OUT, 2 = GND, 3 = V_S

ORDERING CODE

TSOP38... - 1500 pieces in bags

BLOCK DIAGRAM

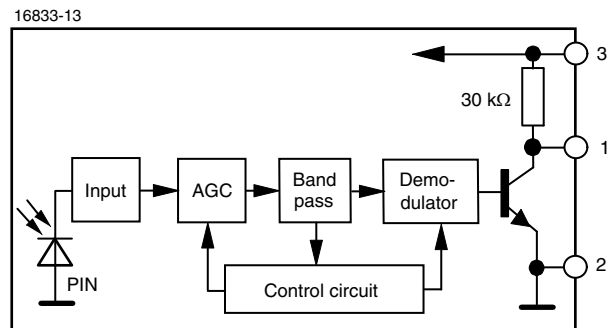

APPLICATION CIRCUIT

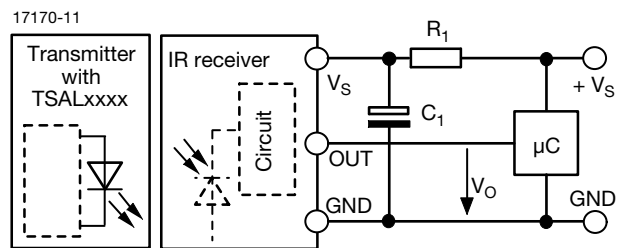

R₁ and C₁ recommended to reduce supply ripple for V_S < 2.8 V



| PARTS TABLE | | | |
|-------------------|--------|---|---|
| AGC | | LEGACY, FOR LONG BURST REMOTE CONTROLS (AGC2) | RECOMMENDED FOR LONG BURST CODES (AGC4) |
| Carrier frequency | 30 kHz | TSOP38230 | TSOP38430 |
| | 33 kHz | TSOP38233 | TSOP38433 |
| | 36 kHz | TSOP38236 | TSOP38436 ⁽¹⁾⁽²⁾⁽³⁾ |
| | 38 kHz | TSOP38238 | TSOP38438 ⁽⁴⁾⁽⁵⁾ |
| | 40 kHz | TSOP38240 | TSOP38440 |
| | 56 kHz | TSOP38256 | TSOP38456 ⁽⁶⁾⁽⁷⁾ |
| Package | | Minicast | |
| Pinning | | 1 = OUT, 2 = GND, 3 = V _S | |
| Dimensions (mm) | | 5.0 W x 6.95 H x 4.8 D | |
| Mounting | | Leaded | |
| Application | | Remote control | |
| Best choice for | | ⁽¹⁾ RC-5 ⁽²⁾ RC-6 ⁽³⁾ Panasonic ⁽⁴⁾ NEC ⁽⁵⁾ Sharp ⁽⁶⁾ r-step ⁽⁷⁾ Thomson RCA | |
| Special options | | • Low voltage option: www.vishay.com/doc?82382 | |

| ABSOLUTE MAXIMUM RATINGS | | | | |
|-----------------------------|--------------------------|------------------|--------------------------------|------|
| PARAMETER | TEST CONDITION | SYMBOL | VALUE | UNIT |
| Supply voltage | | V _S | -0.3 to +6 | V |
| Supply current | | I _S | 3 | mA |
| Output voltage | | V _O | -0.3 to (V _S + 0.3) | V |
| Output current | | I _O | 5 | mA |
| Junction temperature | | T _j | 100 | °C |
| Storage temperature range | | T _{stg} | -25 to +85 | °C |
| Operating temperature range | | T _{amb} | -25 to +85 | °C |
| Power consumption | T _{amb} ≤ 85 °C | P _{tot} | 10 | mW |
| Soldering temperature | t ≤ 10 s, 1 mm from case | T _{sd} | 260 | °C |

Note

- Stresses beyond those listed under “Absolute Maximum Ratings” may cause permanent damage to the device. This is a stress rating only and functional operation of the device at these or any other conditions beyond those indicated in the operational sections of this specification is not implied. Exposure to absolute maximum rating conditions for extended periods may affect the device reliability

| ELECTRICAL AND OPTICAL CHARACTERISTICS (T _{amb} = 25 °C, unless otherwise specified) | | | | | | |
|---|---|---------------------|------|------|------|-------------------|
| PARAMETER | TEST CONDITION | SYMBOL | MIN. | TYP. | MAX. | UNIT |
| Supply current | E _v = 0, V _S = 3.3 V | I _{SD} | 0.27 | 0.35 | 0.45 | mA |
| | E _v = 40 klx, sunlight | I _{SH} | - | 0.45 | - | mA |
| Supply voltage | | V _S | 2.5 | - | 5.5 | V |
| Transmission distance | E _v = 0, test signal see Fig. 1, IR diode TSAL6200, I _F = 50 mA | d | - | 24 | - | m |
| Output voltage low | I _{OSL} = 0.5 mA, E _e = 0.7 mW/m ² , test signal see Fig. 1 | V _{OSL} | - | - | 100 | mV |
| Minimum irradiance | Pulse width tolerance: t _{pi} - 5/f _o < t _{po} < t _{pi} + 6/f _o , test signal see Fig. 1 | E _{e min.} | - | 0.12 | 0.25 | mW/m ² |
| Maximum irradiance | t _{pi} - 5/f _o < t _{po} < t _{pi} + 6/f _o , test signal see Fig. 1 | E _{e max.} | 30 | - | - | W/m ² |
| Directivity | Angle of half transmission distance | φ _{1/2} | - | ± 45 | - | ° |

TYPICAL CHARACTERISTICS ($T_{amb} = 25\text{ }^{\circ}\text{C}$, unless otherwise specified)



Fig. 1 - Output Active Low

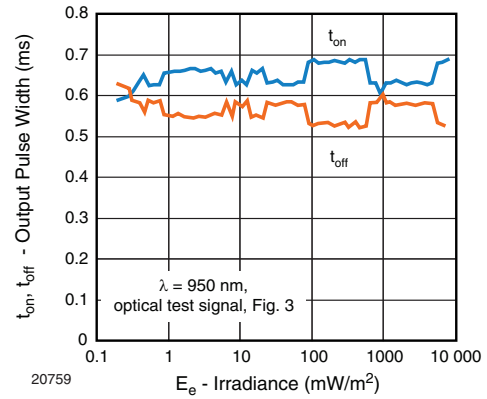

Fig. 4 - Output Pulse Diagram

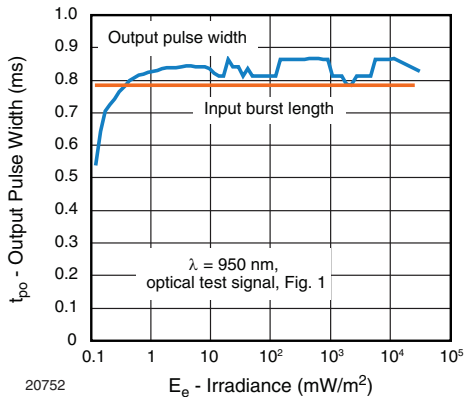

Fig. 2 - Pulse Length and Sensitivity in Dark Ambient

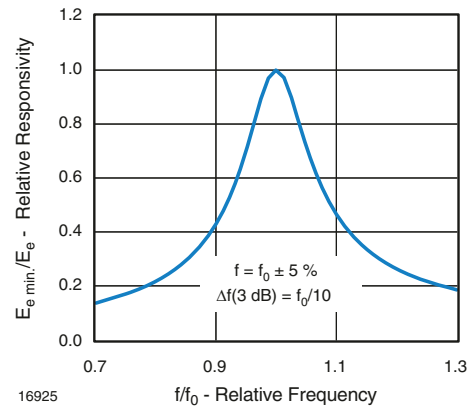

Fig. 5 - Frequency Dependence of Responsivity



Fig. 3 - Output Function

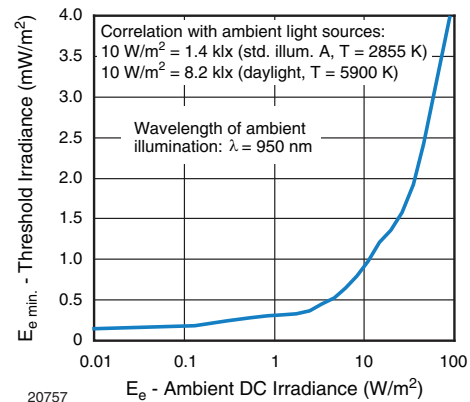

Fig. 6 - Sensitivity in Bright Ambient

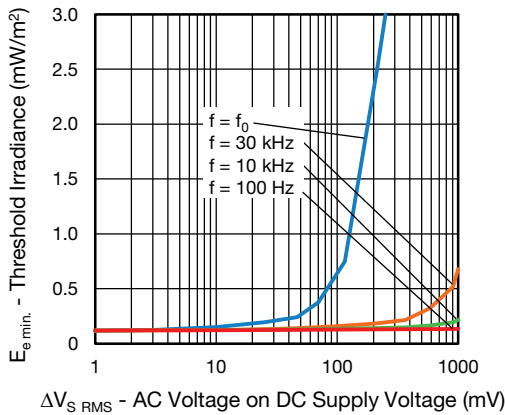

Fig. 7 - Sensitivity vs. Supply Voltage Disturbances

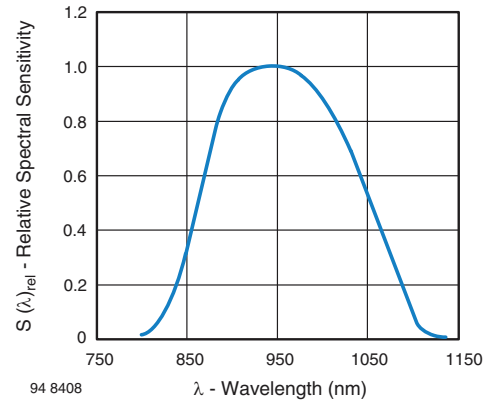

Fig. 10 - Relative Spectral Sensitivity vs. Wavelength

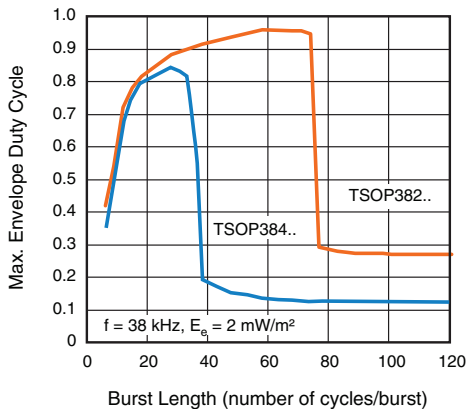

Fig. 8 - Max. Envelope Duty Cycle vs. Burst Length

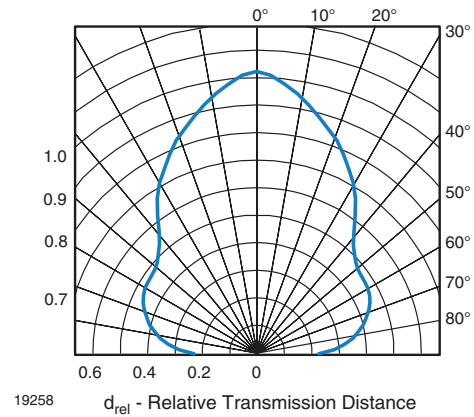

Fig. 11 - Horizontal Directivity

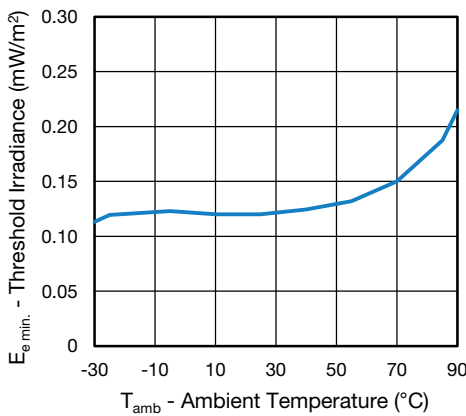

Fig. 9 - Sensitivity vs. Ambient Temperature

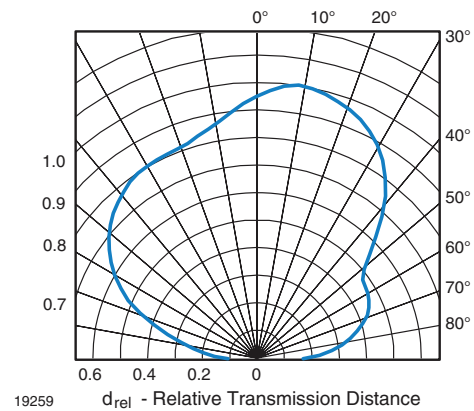

Fig. 12 - Vertical Directivity

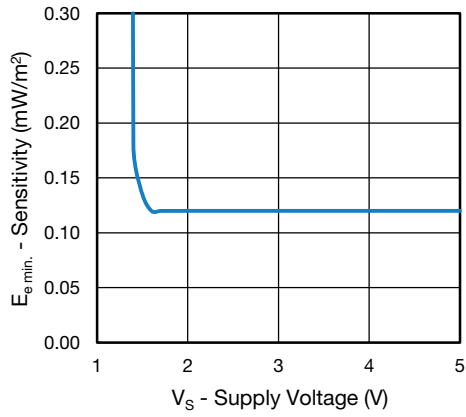

Fig. 13 - Sensitivity vs. Supply Voltage

SUITABLE DATA FORMAT

This series is designed to suppress spurious output pulses due to noise or disturbance signals. The devices can distinguish data signals from noise due to differences in frequency, burst length, and envelope duty cycle. The data signal should be close to the device's band-pass center frequency (e.g. 38 kHz) and fulfill the conditions in the table below.

When a data signal is applied to the product in the presence of a disturbance, the sensitivity of the receiver is automatically reduced by the AGC to insure that no spurious pulses are present at the receiver's output.

Some examples which are suppressed are:

- DC light (e.g. from tungsten bulbs sunlight)
- Continuous signals at any frequency
- Strongly or weakly modulated patterns from fluorescent lamps with electronic ballasts (see Fig. 14 or Fig. 15)



Fig. 14 - IR Disturbance from Fluorescent Lamp With Low Modulation



Fig. 15 - IR Disturbance from Fluorescent Lamp With High Modulation

| | TSOP382.. | TSOP384.. |
|--|---|---|
| Minimum burst length | 10 cycles/burst | 10 cycles/burst |
| After each burst of length a minimum gap time is required of | 10 to 70 cycles ≥ 10 cycles | 10 to 35 cycles ≥ 10 cycles |
| For bursts greater than a minimum gap time in the data stream is needed of | 70 cycles > 4 x burst length | 35 cycles > 10 x burst length |
| Maximum number of continuous short bursts/second | 1800 | 1500 |
| NEC code | Yes | Preferred |
| RC5/RC6 code | Yes | Preferred |
| Thomson 56 kHz code | Yes | Preferred |
| Sharp code | Yes | Preferred |
| Suppression of interference from fluorescent lamps | Mild disturbance patterns are suppressed (example: signal pattern of Fig. 14) | Complex and critical disturbance patterns are suppressed (example: signal pattern of Fig. 15 or highly dimmed LCDs) |

Notes

- For data formats with short bursts please see the datasheet for TSOP383.., TSOP385..
- For Sony 12, 15, and 20 bit IR codes please see the datasheet of TSOP38S40



PACKAGE DIMENSIONS in millimeters

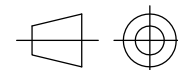
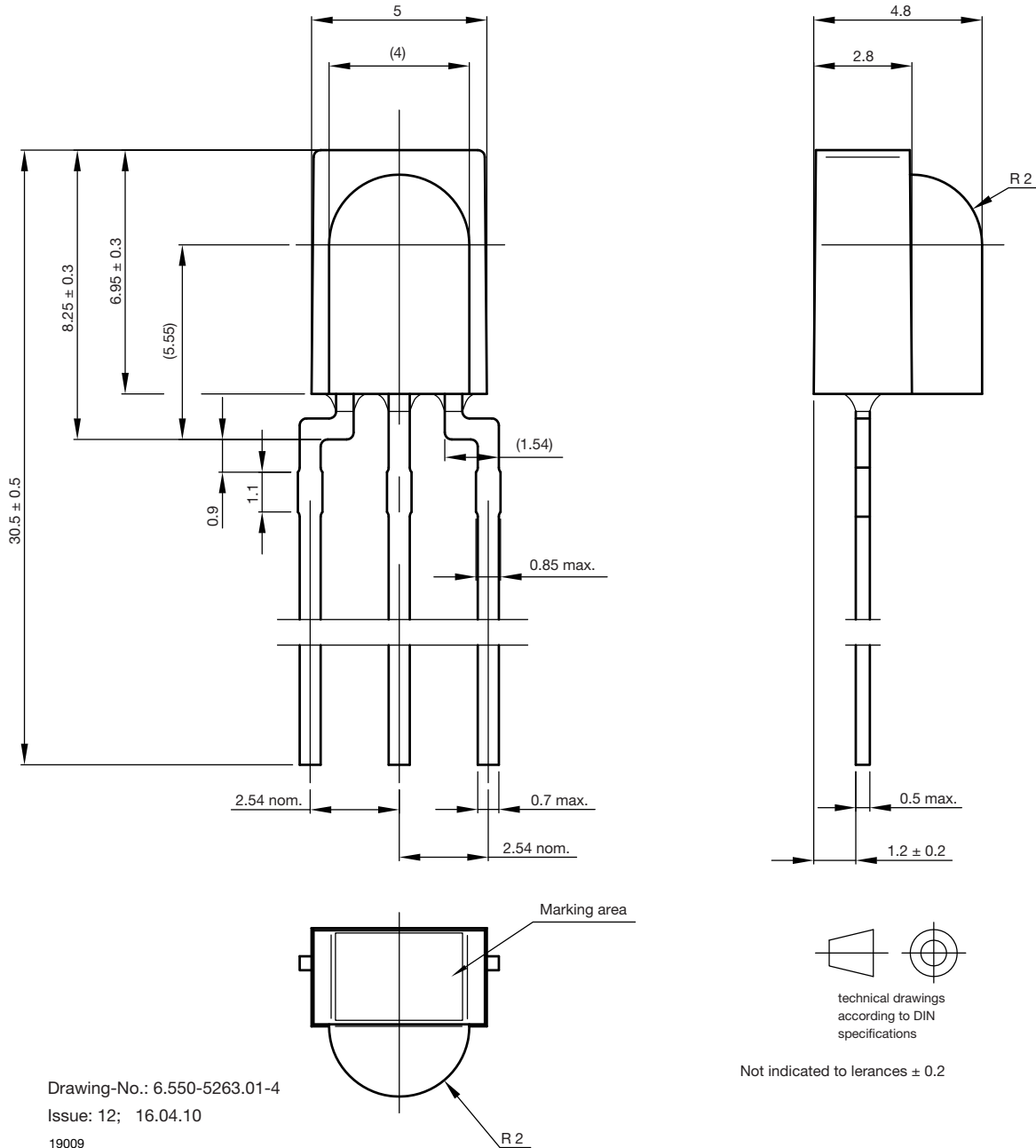

technical drawings according to DIN specifications

Not indicated to tolerances ± 0.2

Drawing-No.: 6.550-5263.01-4
Issue: 12; 16.04.10
19009



Disclaimer

ALL PRODUCT, PRODUCT SPECIFICATIONS AND DATA ARE SUBJECT TO CHANGE WITHOUT NOTICE TO IMPROVE RELIABILITY, FUNCTION OR DESIGN OR OTHERWISE.

Vishay Intertechnology, Inc., its affiliates, agents, and employees, and all persons acting on its or their behalf (collectively, "Vishay"), disclaim any and all liability for any errors, inaccuracies or incompleteness contained in any datasheet or in any other disclosure relating to any product.

Vishay makes no warranty, representation or guarantee regarding the suitability of the products for any particular purpose or the continuing production of any product. To the maximum extent permitted by applicable law, Vishay disclaims (i) any and all liability arising out of the application or use of any product, (ii) any and all liability, including without limitation special, consequential or incidental damages, and (iii) any and all implied warranties, including warranties of fitness for particular purpose, non-infringement and merchantability.

Statements regarding the suitability of products for certain types of applications are based on Vishay's knowledge of typical requirements that are often placed on Vishay products in generic applications. Such statements are not binding statements about the suitability of products for a particular application. It is the customer's responsibility to validate that a particular product with the properties described in the product specification is suitable for use in a particular application. Parameters provided in datasheets and / or specifications may vary in different applications and performance may vary over time. All operating parameters, including typical parameters, must be validated for each customer application by the customer's technical experts. Product specifications do not expand or otherwise modify Vishay's terms and conditions of purchase, including but not limited to the warranty expressed therein.

Hyperlinks included in this datasheet may direct users to third-party websites. These links are provided as a convenience and for informational purposes only. Inclusion of these hyperlinks does not constitute an endorsement or an approval by Vishay of any of the products, services or opinions of the corporation, organization or individual associated with the third-party website. Vishay disclaims any and all liability and bears no responsibility for the accuracy, legality or content of the third-party website or for that of subsequent links.

Except as expressly indicated in writing, Vishay products are not designed for use in medical, life-saving, or life-sustaining applications or for any other application in which the failure of the Vishay product could result in personal injury or death. Customers using or selling Vishay products not expressly indicated for use in such applications do so at their own risk. Please contact authorized Vishay personnel to obtain written terms and conditions regarding products designed for such applications.

No license, express or implied, by estoppel or otherwise, to any intellectual property rights is granted by this document or by any conduct of Vishay. Product names and markings noted herein may be trademarks of their respective owners.