

APPROVAL SHEET

WLCM0603TG Multi-Layer Ceramic High Frequency High Q Inductors

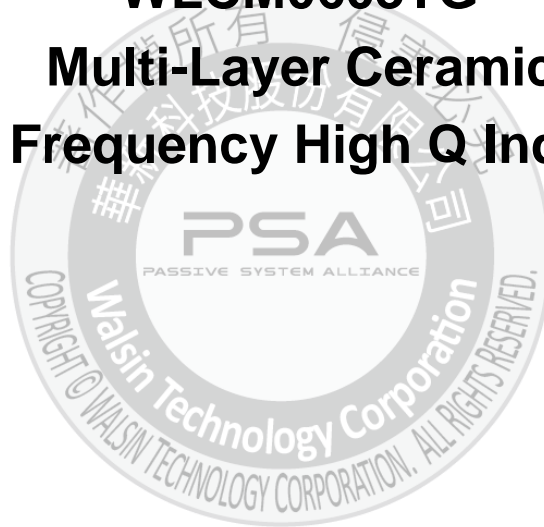

*Contents in this sheet are subject to change without prior notice.

FEATURES

1. Particular ceramic material and coil structure provide high frequency application range up to 10GHz.
2. Small size and low profile.
3. Available in various sizes.
4. Excellent solderability and heat resistance.
5. RoHS compliance.

APPLICATIONS

1. RF and wireless communication
2. Computer, telecommunications
3. Radar detectors, automotive electronics, cellular phones, pagers.
4. Audio equipment, PDAs, keyless remote system and low-voltage power supply modules.

SHAPE and DIMENSION

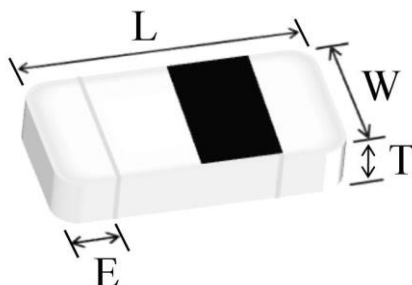

Unit: mm

WLCM Series	L	W	T	E (Min/Max)	Packing Quantity (pcs/reel)
					Paper Tape
WLCM0603TG (EIA 0201)	0.60±0.03	0.30±0.03	0.30±0.03	0.10~0.20	15,000

Ordering Information

WL	CM	0603	TG	S	1N2	T	B
Product Code WL: Inductor	Series Ceramic multilayer inductor.	Dimensions 0603:EIA 0201	Series extension TG: Freq. 500 MHz	Tolerance B: ± 0.1nH C: ± 0.2nH H: ± 3% J: ± 5%	Value 1N2 =1.2nH 12N=12nH R10=100nH =0.10uH	Packing Code T=7" Reeled (Paper tape)	B:STD

Electrical Characteristics

- WLCM0603TG series (EIA 0201)

Operating Temperature range: -55°C to 125°C

Walsin Part Number	L(nH)	Tolerance	Q Min	Typical Q @ Frequency (MHz)	SRF (MHz)	RDC (Ω)	Rated Current (mA) Max.
					Min.	Max.	
WLCM0603TG□0N3TB	0.3	B, C	11	500	18,000	0.07	850
WLCM0603TG□0N4TB	0.4	B, C	11	500	18,000	0.07	850
WLCM0603TG□0N5TB	0.5	B, C	11	500	18,000	0.08	850
WLCM0603TG□0N6TB	0.6	B, C	11	500	18,000	0.08	850
WLCM0603TG□0N7TB	0.7	B, C	12	500	18,000	0.09	750
WLCM0603TG□0N8TB	0.8	B, C	12	500	18,000	0.10	750
WLCM0603TG□0N9TB	0.9	B, C	12	500	18,000	0.12	700
WLCM0603TG□1N0TB	1.0	B, C	12	500	17,000	0.14	600
WLCM0603TG□1N1TB	1.1	B, C	12	500	17,000	0.14	600
WLCM0603TG□1N2TB	1.2	B, C	12	500	15,000	0.14	600
WLCM0603TG□1N3TB	1.3	B, C	12	500	15,000	0.15	600
WLCM0603TG□1N4TB	1.4	B, C	12	500	14,000	0.15	600
WLCM0603TG□1N5TB	1.5	B, C	12	500	13,500	0.15	600
WLCM0603TG□1N6TB	1.6	B, C	12	500	13,000	0.15	600
WLCM0603TG□1N7TB	1.7	B, C	12	500	12,500	0.19	500
WLCM0603TG□1N8TB	1.8	B, C	12	500	12,500	0.20	500
WLCM0603TG□1N9TB	1.9	B, C	12	500	12,500	0.20	450
WLCM0603TG□2N0TB	2.0	B, C	12	500	12,500	0.20	450
WLCM0603TG□2N1TB	2.1	B, C	12	500	12,000	0.22	450
WLCM0603TG□2N2TB	2.2	B, C	12	500	12,000	0.22	450
WLCM0603TG□2N3TB	2.3	B, C	12	500	11,500	0.24	450
WLCM0603TG□2N4TB	2.4	B, C	12	500	11,000	0.25	450
WLCM0603TG□2N5TB	2.5	B, C	12	500	11,000	0.25	450
WLCM0603TG□2N6TB	2.6	B, C	12	500	11,000	0.25	450
WLCM0603TG□2N7TB	2.7	B, C	12	500	11,000	0.25	450
WLCM0603TG□2N8TB	2.8	B, C	12	500	9,500	0.25	450
WLCM0603TG□2N9TB	2.9	B, C	12	500	9,500	0.25	450
WLCM0603TG□3N0TB	3.0	B, C	12	500	9,500	0.25	450
WLCM0603TG□3N1TB	3.1	B, C	12	500	9,500	0.30	450
WLCM0603TG□3N2TB	3.2	B, C	12	500	9,500	0.30	450
WLCM0603TG□3N3TB	3.3	B, C	12	500	9,500	0.30	400
WLCM0603TG□3N4TB	3.4	B, C	12	500	8,000	0.30	400
WLCM0603TG□3N5TB	3.5	B, C	12	500	8,000	0.30	400
WLCM0603TG□3N6TB	3.6	B, C	12	500	8,000	0.30	400
WLCM0603TG□3N7TB	3.7	B, C	12	500	7,000	0.30	400
WLCM0603TG□3N8TB	3.8	B, C	12	500	7,000	0.35	350
WLCM0603TG□3N9TB	3.9	B, C	12	500	6,500	0.35	350
WLCM0603TG□4N3TB	4.3	H, J	12	500	6,500	0.40	350
WLCM0603TG□4N7TB	4.7	H, J	12	500	6,500	0.40	350
WLCM0603TG□5N1TB	5.1	H, J	12	500	6,500	0.40	350

Walsin Part Number	L(nH)	Tolerance	Q Min	Typical Q @ Frequency (MHz)	SRF (MHz)	RDC (Ω)	Rated Current (mA) Max.
					Min.	Max.	
WLCM0603TG□5N6TB	5.6	H, J	12	500	6,000	0.44	300
WLCM0603TG□6N2TB	6.2	H, J	12	500	6,000	0.50	300
WLCM0603TG□6N8TB	6.8	H, J	12	500	5,400	0.53	300
WLCM0603TG□7N5TB	7.5	H, J	12	500	4,800	0.55	250
WLCM0603TG□8N2TB	8.2	H, J	12	500	4,800	0.62	250
WLCM0603TG□9N1TB	9.1	H, J	12	500	4,500	0.65	250
WLCM0603TG□10NTB	10	H, J	11	500	4,000	0.70	250
WLCM0603TG□12NTB	12	H, J	11	500	3,700	0.75	250
WLCM0603TG□15NTB	15	H, J	11	500	3,100	0.85	250
WLCM0603TG□18NTB	18	H, J	11	500	2,800	1.00	200
WLCM0603TG□22NTB	22	H, J	9	500	2,500	1.20	150
WLCM0603TG□27NTB	27	H, J	9	500	1800	1.80	140
WLCM0603TG□33NTB	33	H, J	7	300	1700	2.10	120
WLCM0603TG□39NTB	39	H, J	7	300	1500	2.40	120

Typical Electrical Characteristic

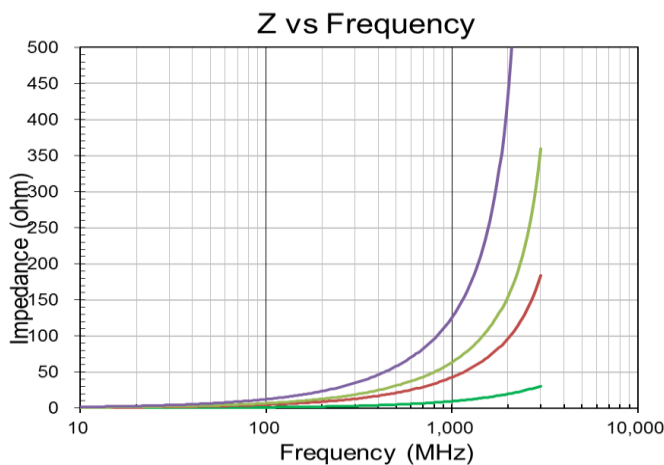
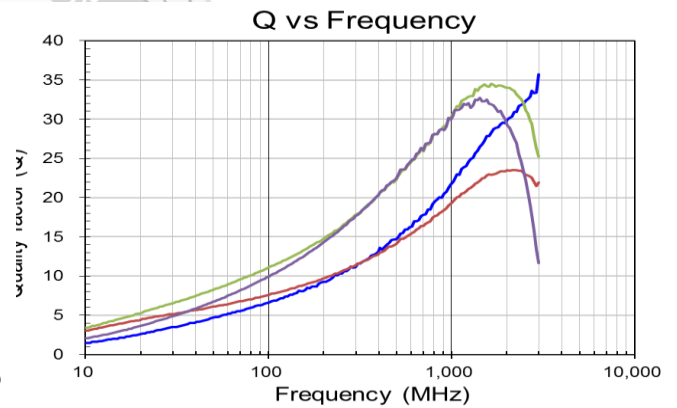
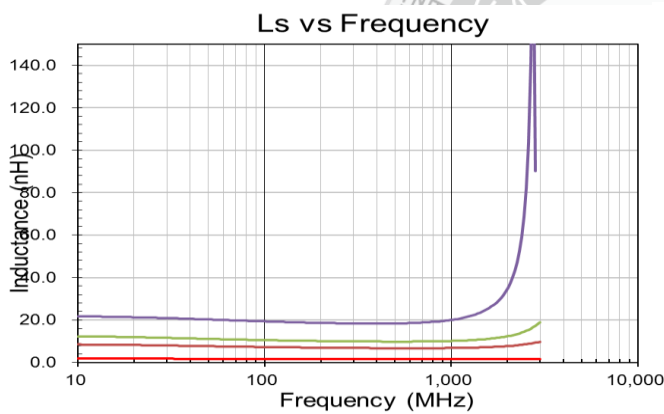

Typical Electrical Characteristic

WLCM0603TG□0N3TB

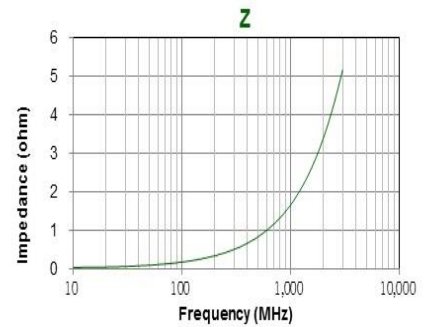
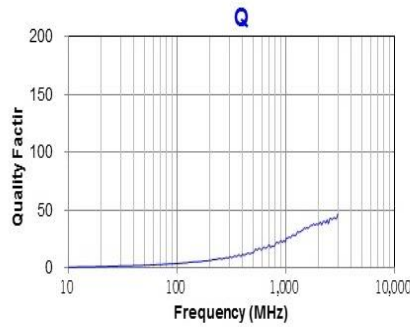
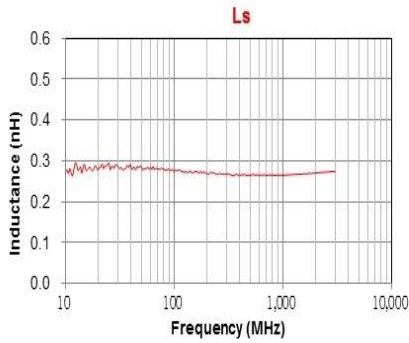

WLCM0603TG□0N4TB

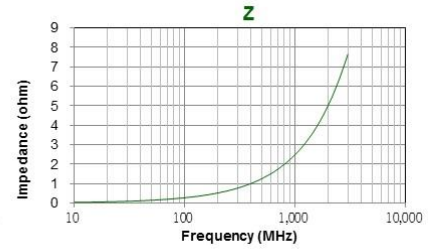
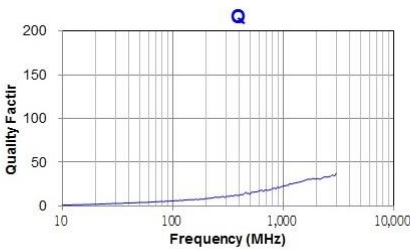
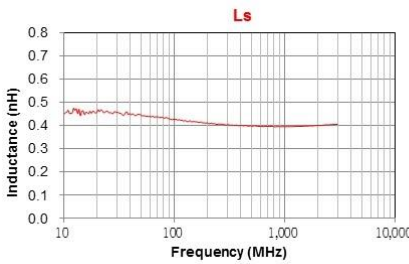

WLCM0603TG□0N5TB

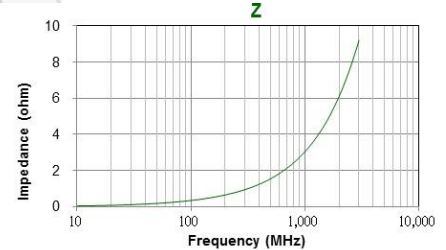
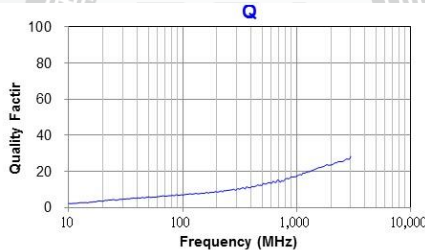
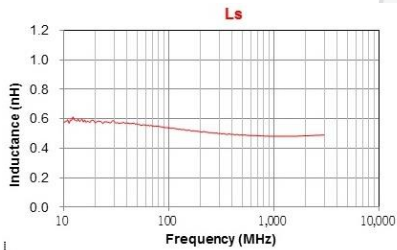

WLCM0603TG□0N6TB

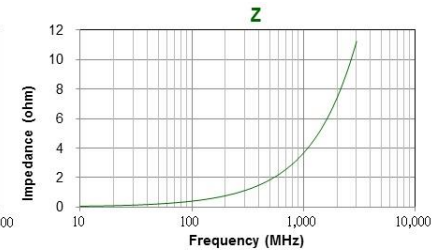
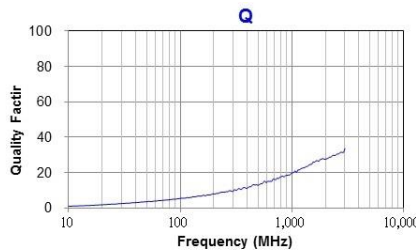
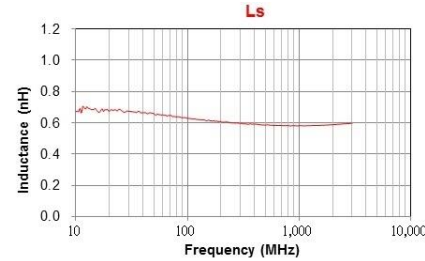

WLCM0603TG□0N7TB

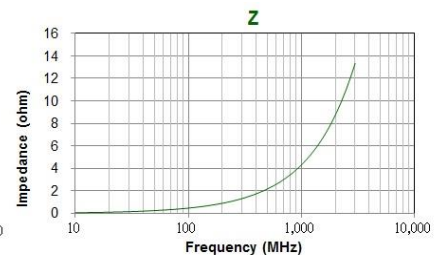
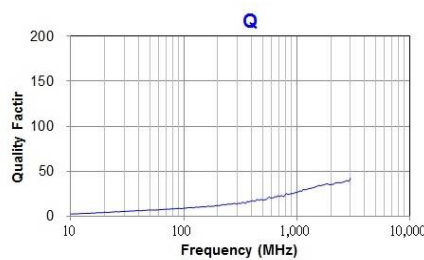
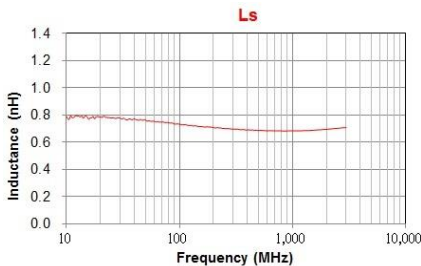

WLCM0603TG□0N8TB

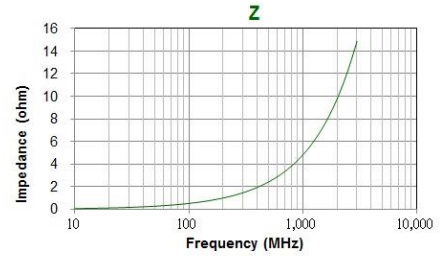
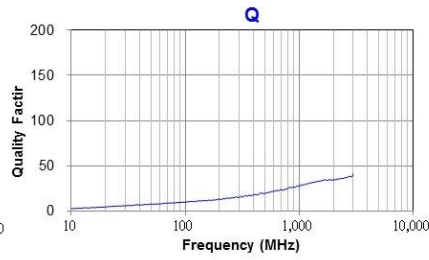
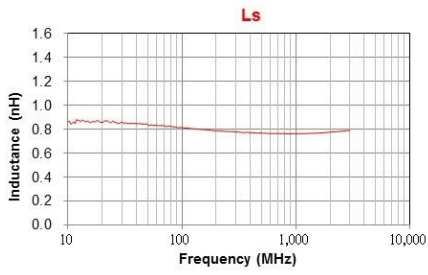

WLCM0603TG□0N9TB

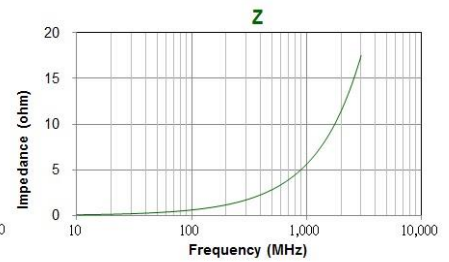
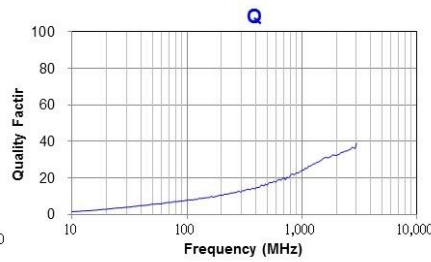
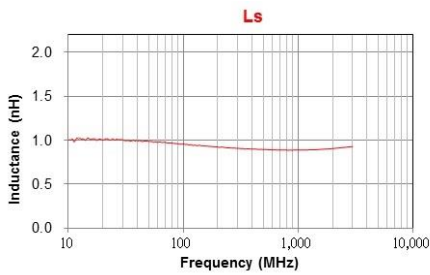

WLCM0603TG□1N0TB

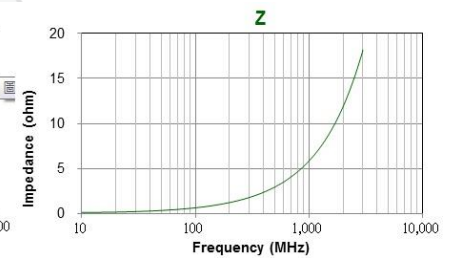
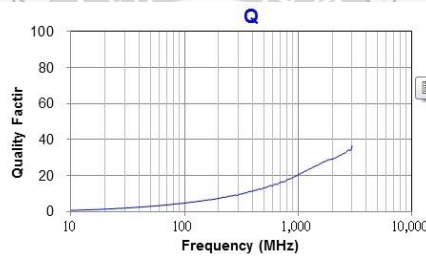
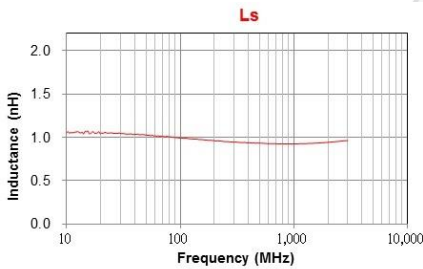

WLCM0603TG□1N1TB

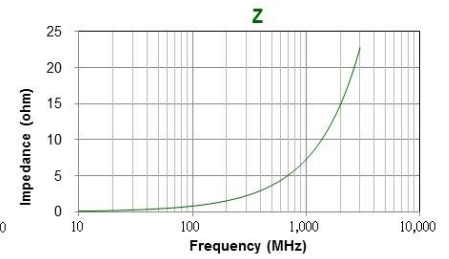
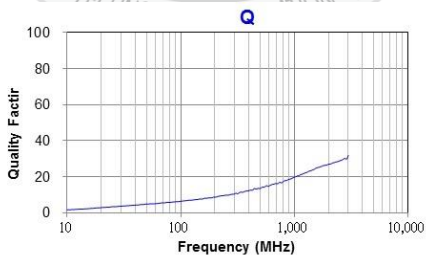
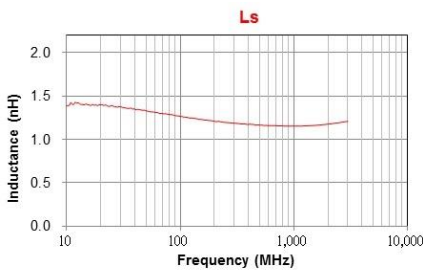

WLCM0603TG□1N2TB

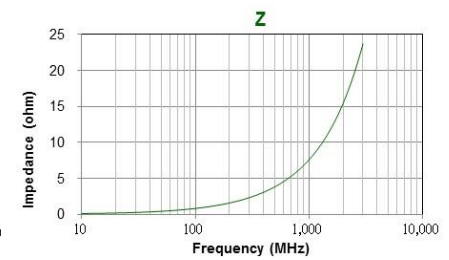
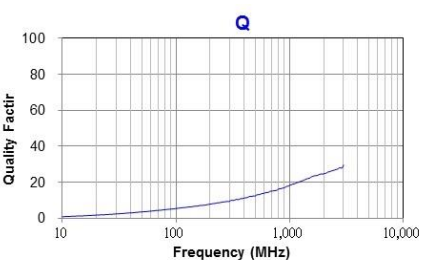
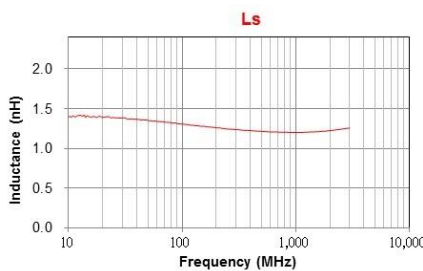

WLCM0603TG□1N3TB

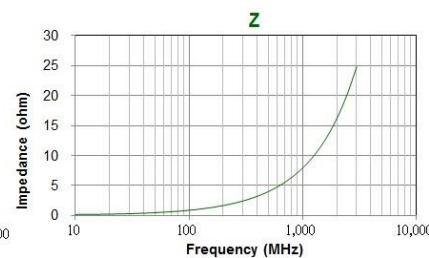
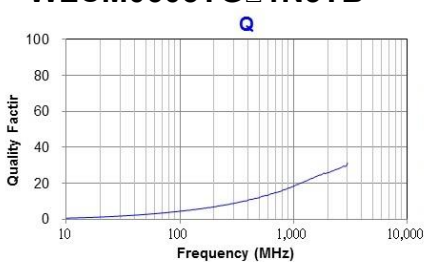
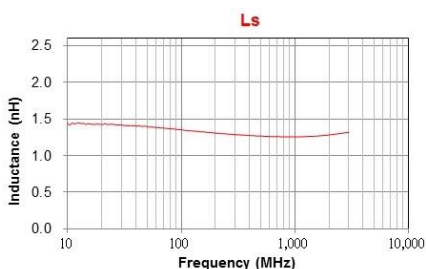

WLCM0603TG□1N4TB

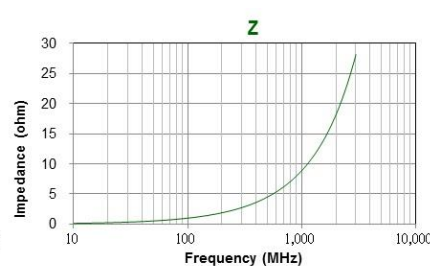
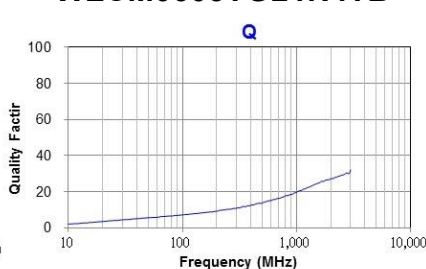
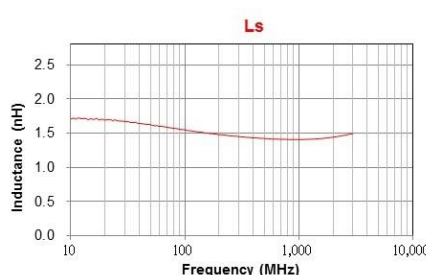

WLCM0603TG□1N5TB

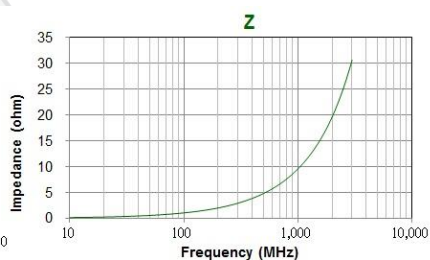
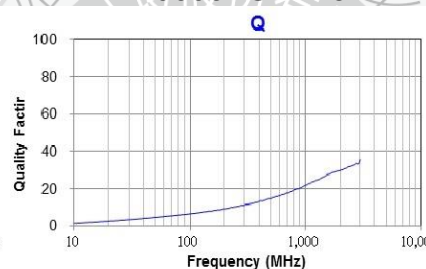
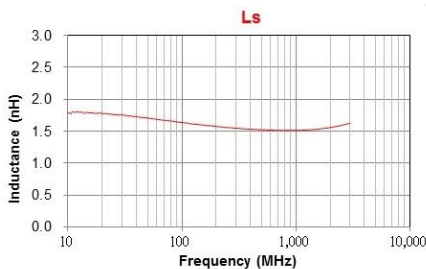

WLCM0603TG□1N6TB

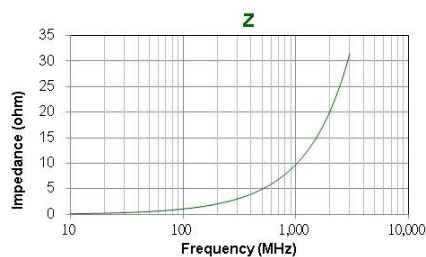
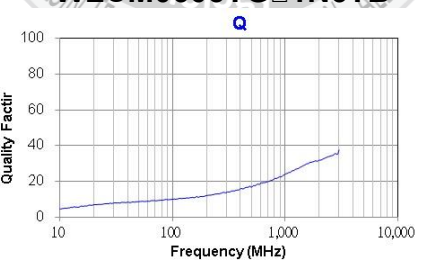
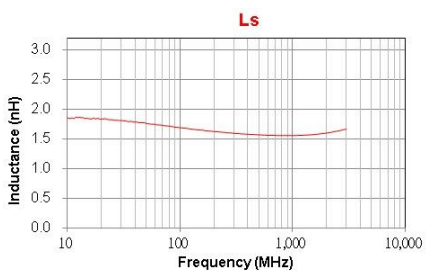

WLCM0603TG□1N7TB

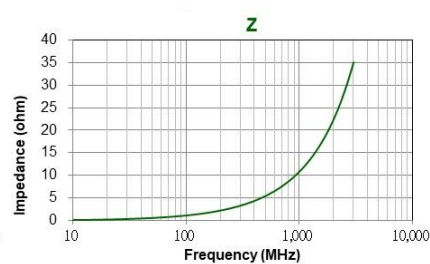
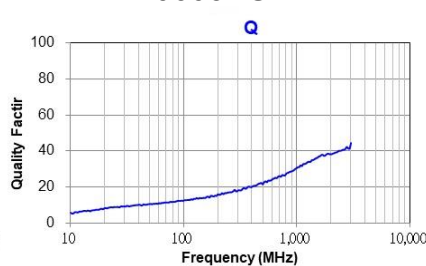
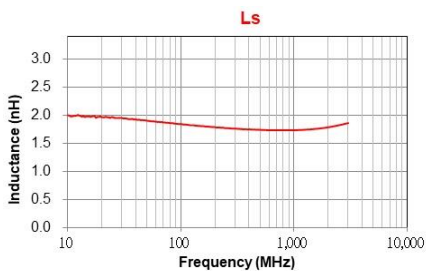

WLCM0603TG□1N8TB

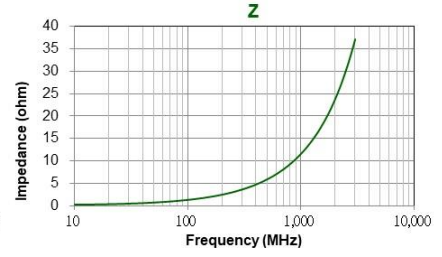
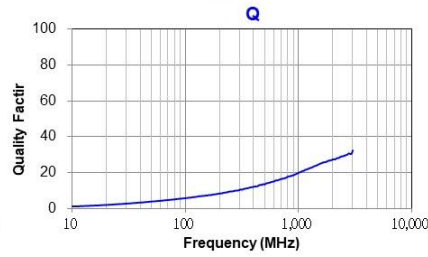
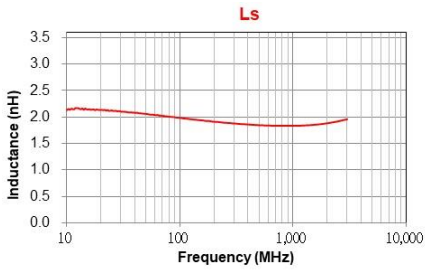

WLCM0603TG□1N9TB

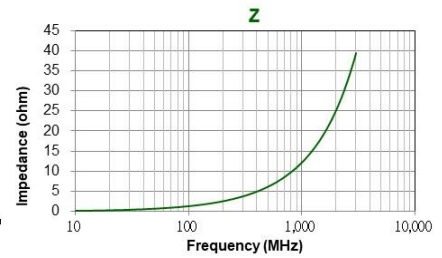
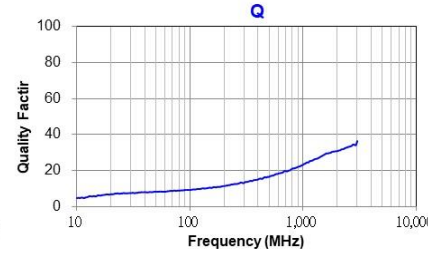
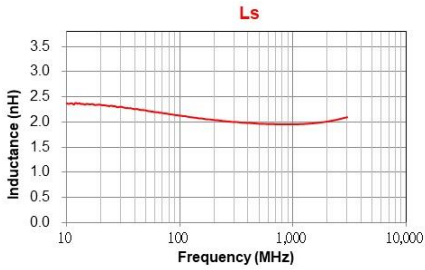

WLCM0603TG□2N0TB

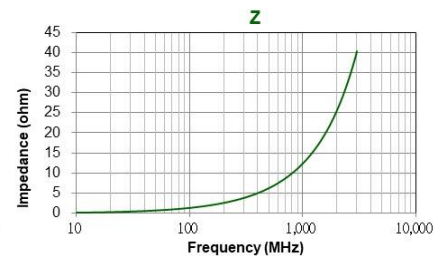
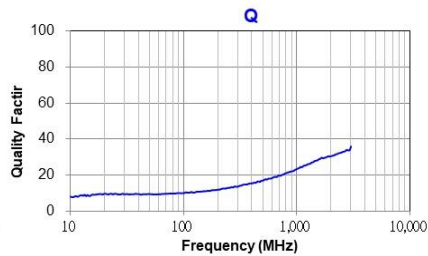
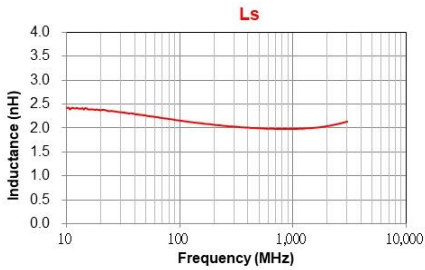

WLCM0603TG□2N1TB

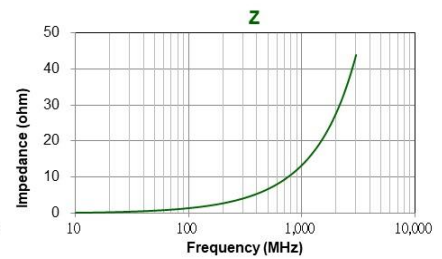
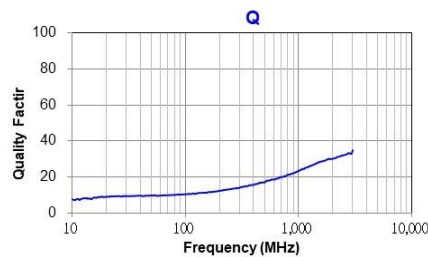
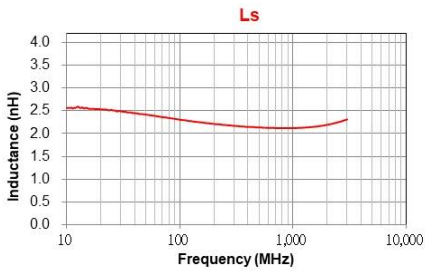

WLCM0603TG□2N2TB

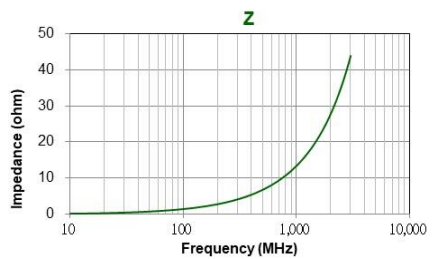
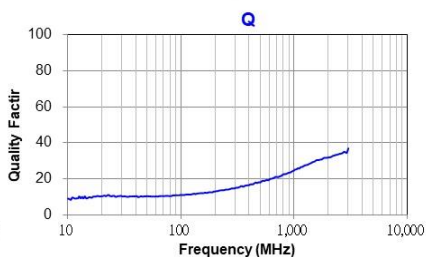
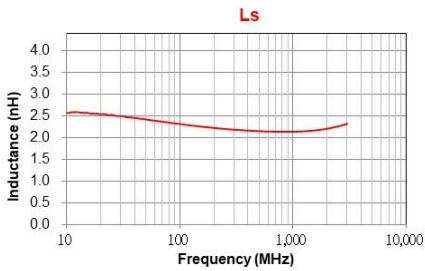

WLCM0603TG□2N3TB

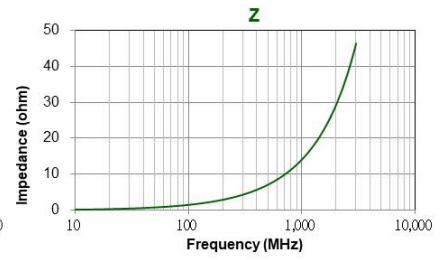
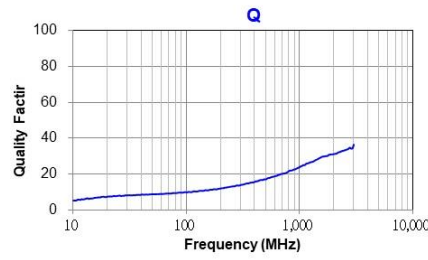
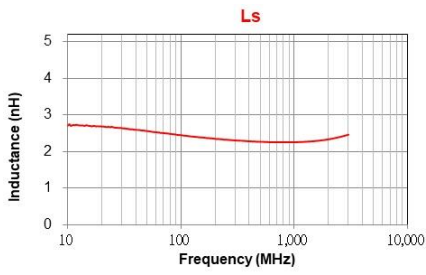

WLCM0603TG□2N4TB

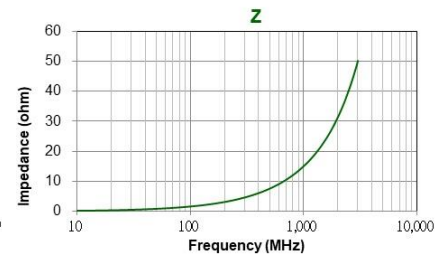
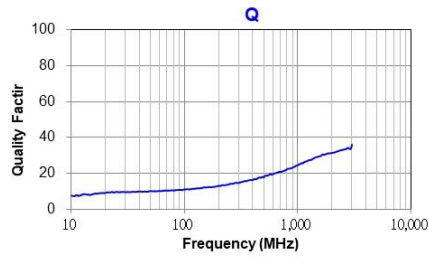
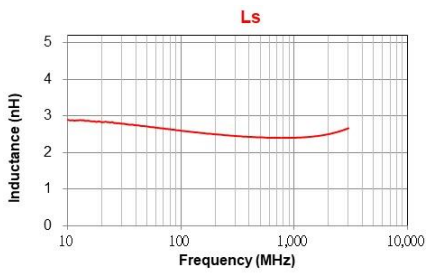

WLCM0603TG□2N5TB

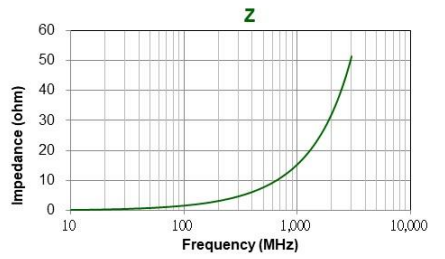
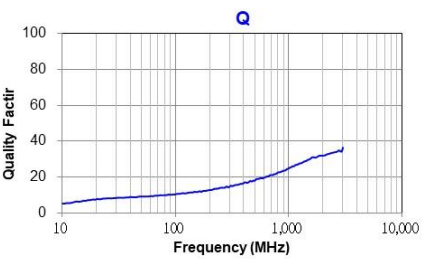
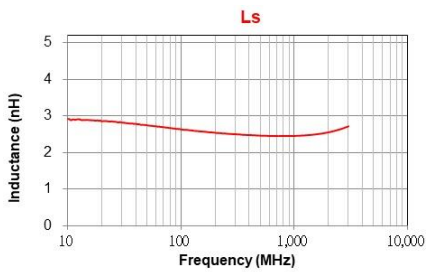

WLCM0603TG□2N6TB

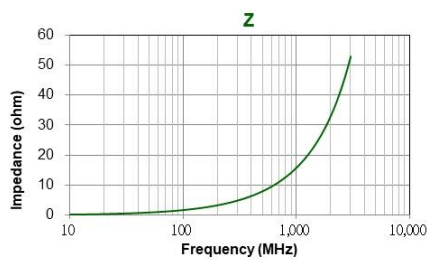
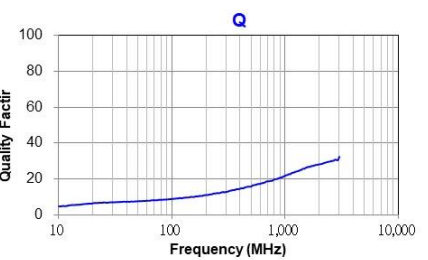
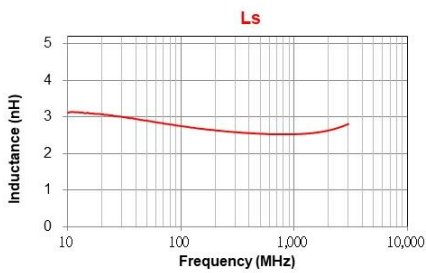

WLCM0603TG□2N7TB

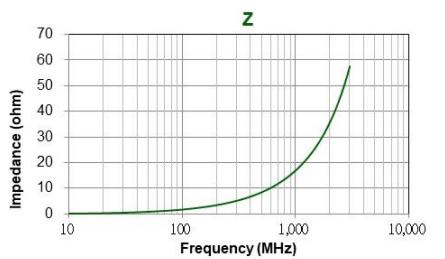
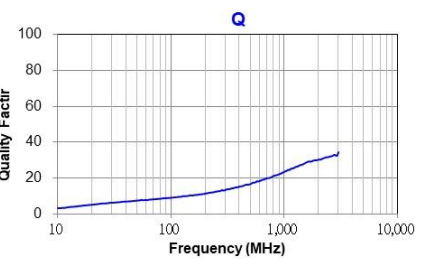
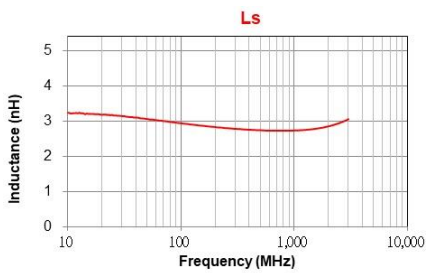

WLCM0603TG□2N8TB

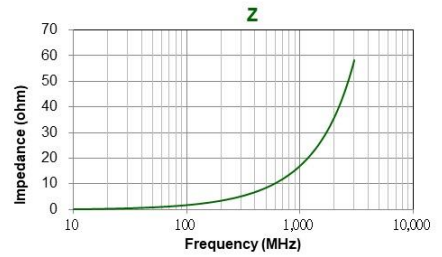
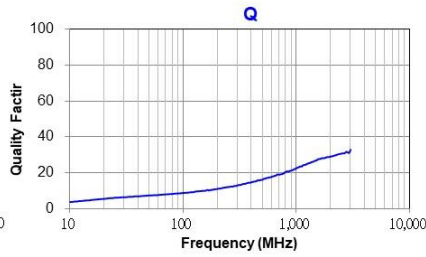
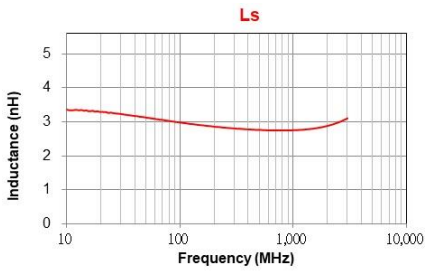

WLCM0603TG□2N9TB

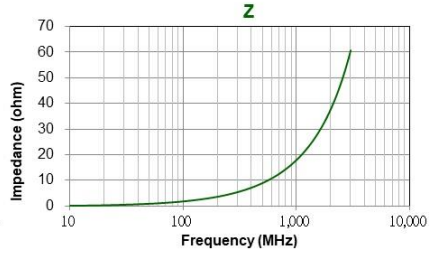
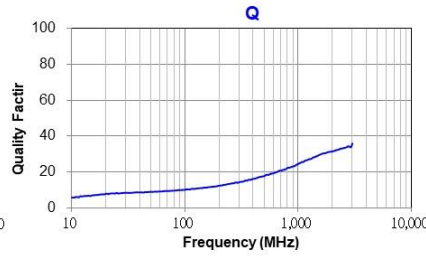
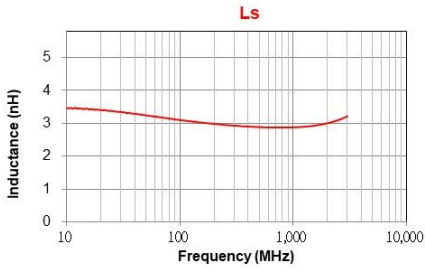

WLCM0603TG□3N0TB

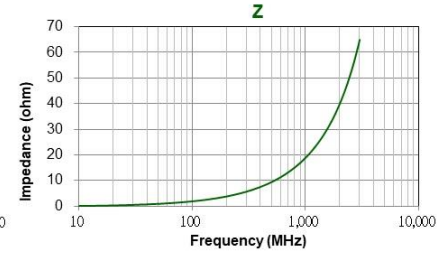
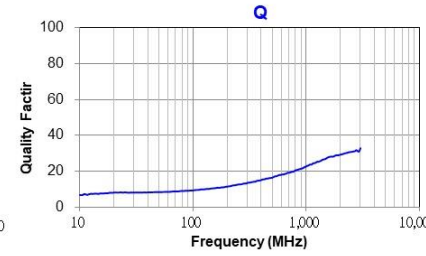
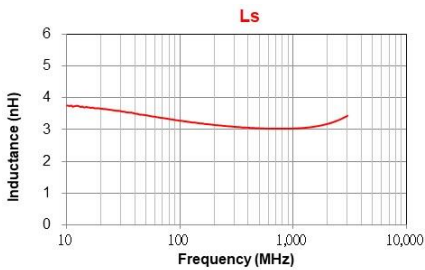

WLCM0603TG□3N1TB

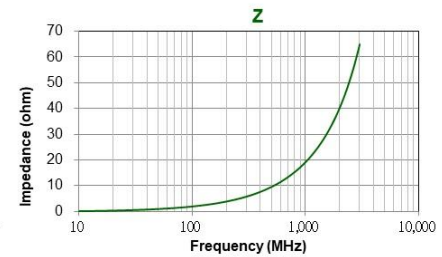
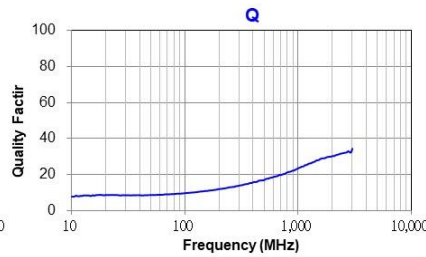
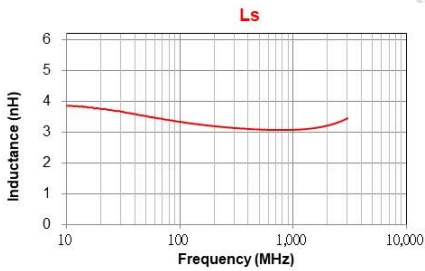

WLCM0603TG□3N2TB

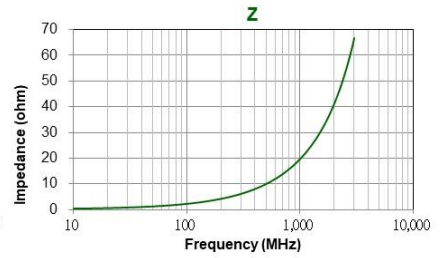
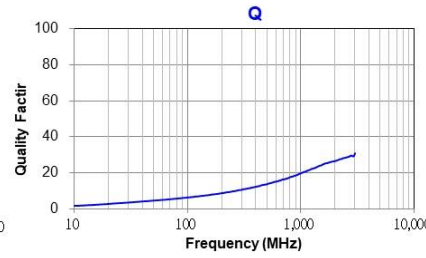
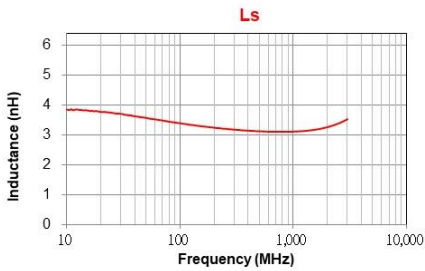

WLCM0603TG□3N3TB

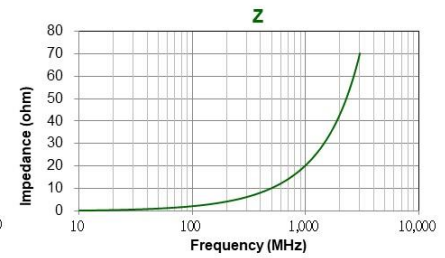
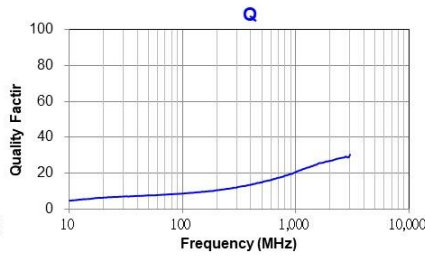
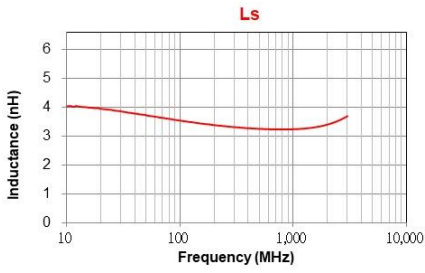

WLCM0603TG□3N4TB

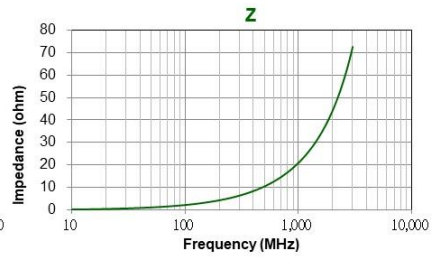
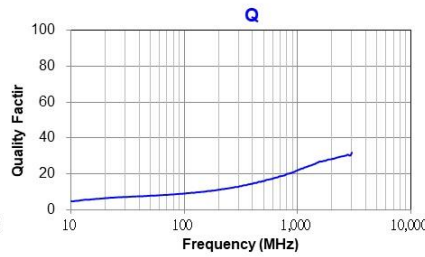
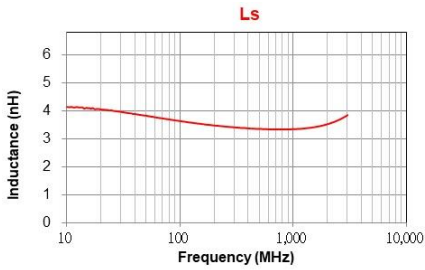

WLCM0603TG□3N5TB

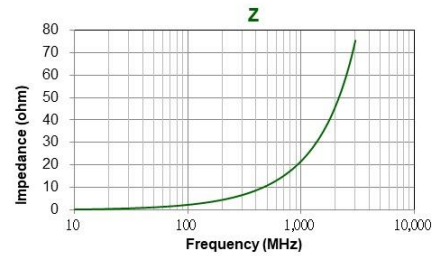
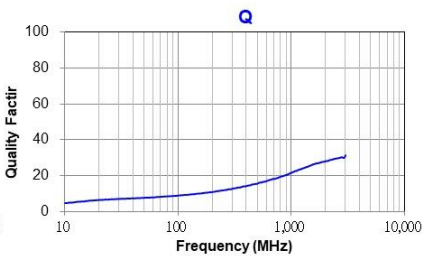
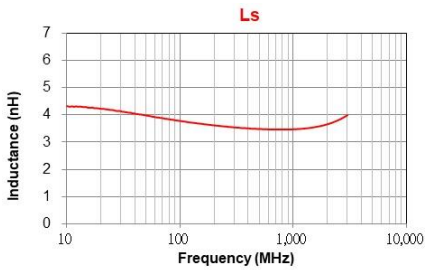

WLCM0603TG□3N6TB

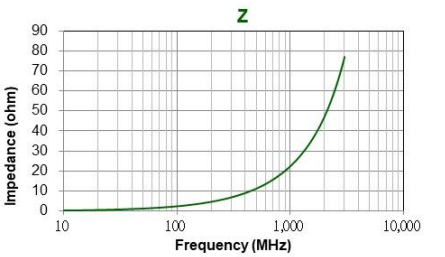
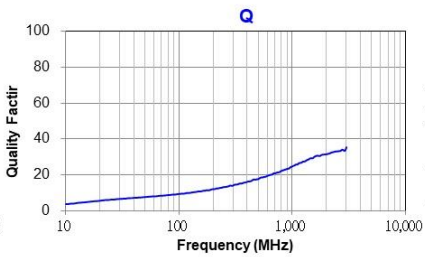
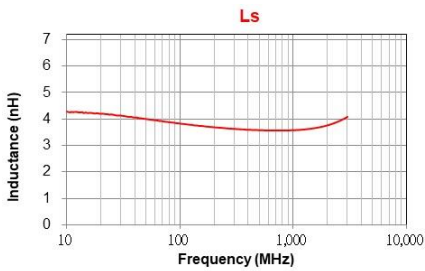

WLCM0603TG□3N7TB

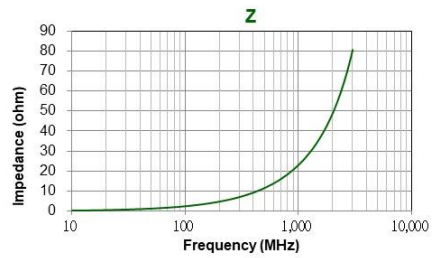
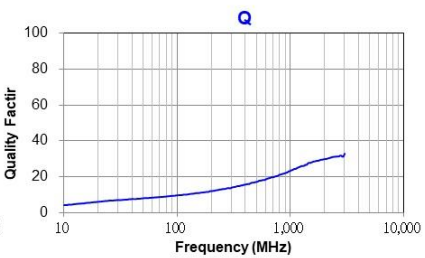
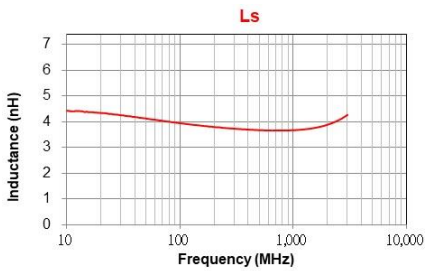

WLCM0603TG□3N8TB

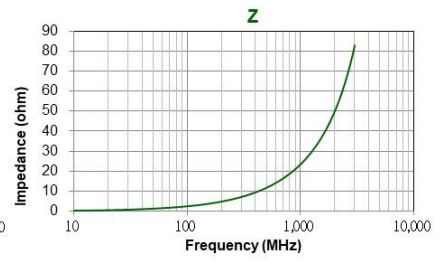
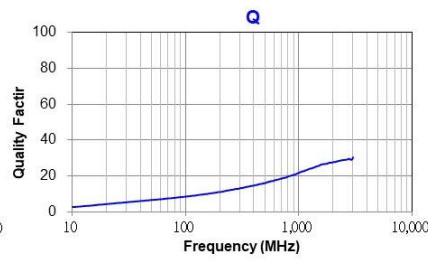
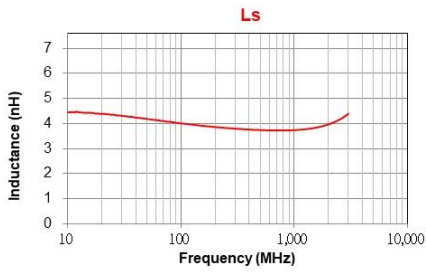

WLCM0603TG□3N9TB

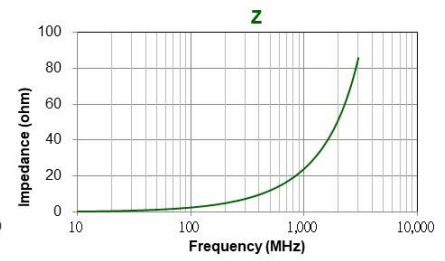
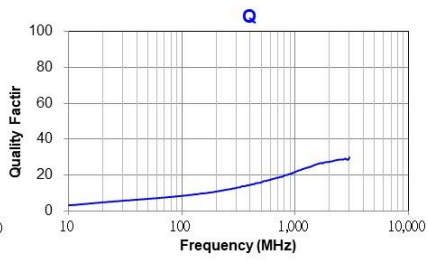
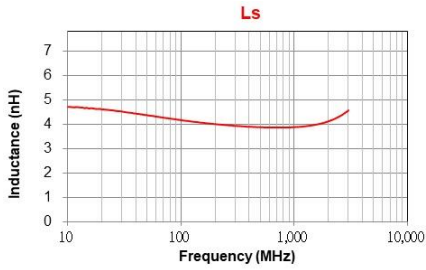

WLCM0603TG□4N3TB

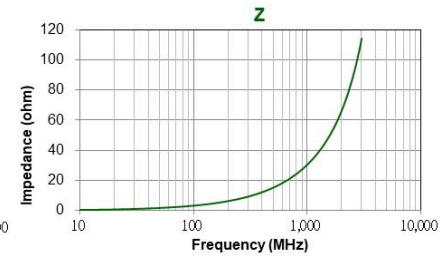
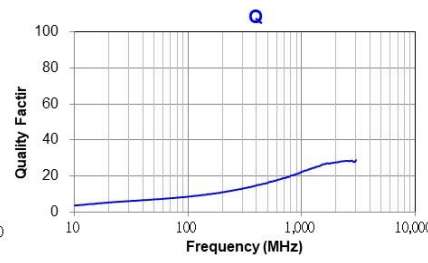
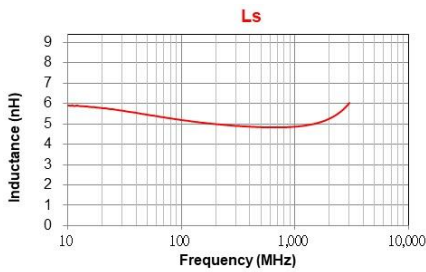

WLCM0603TG□4N7TB

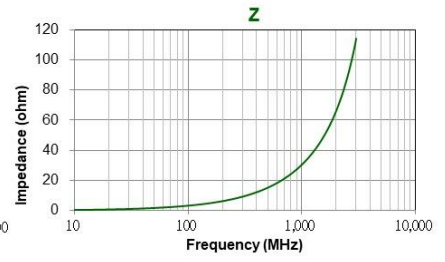
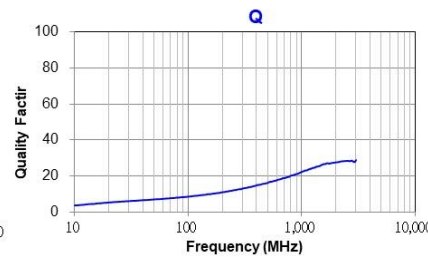
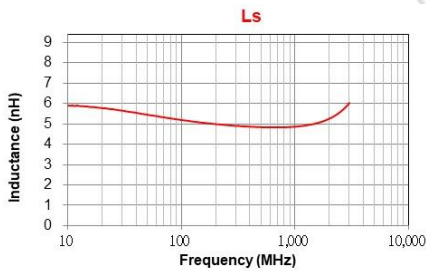

WLCM0603TG□5N1TB

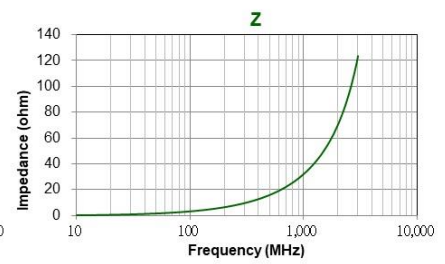
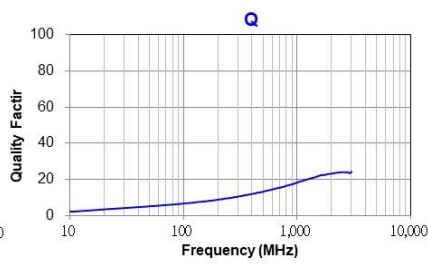
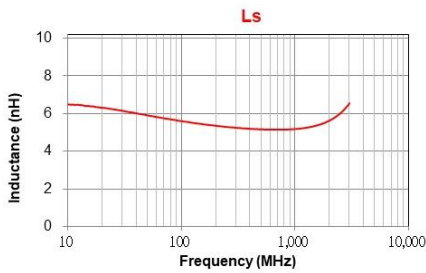

WLCM0603TG□5N6TB

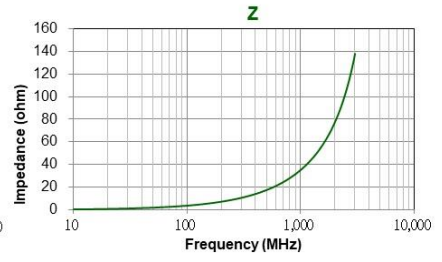
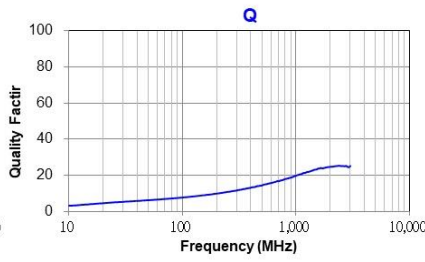
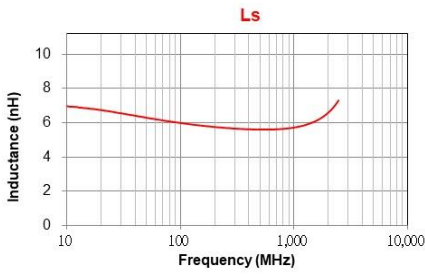

WLCM0603TG□6N2TB

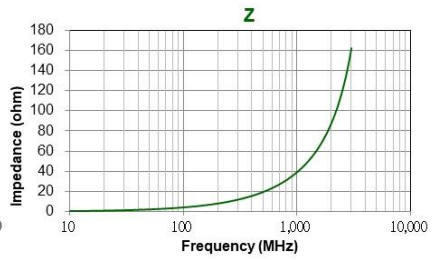
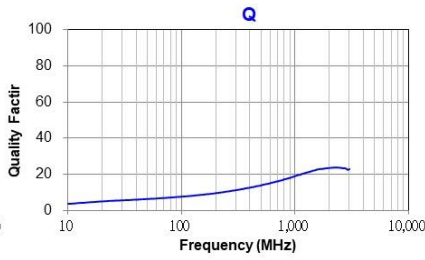
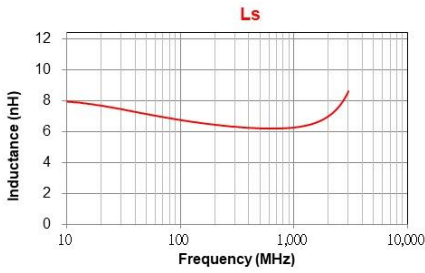

WLCM0603TG□6N8TB

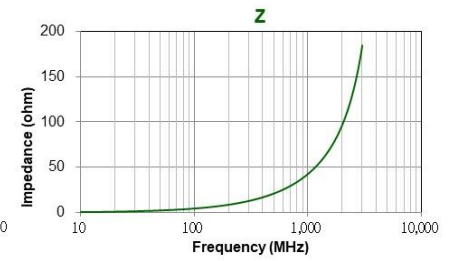
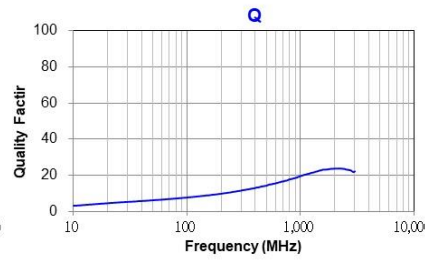
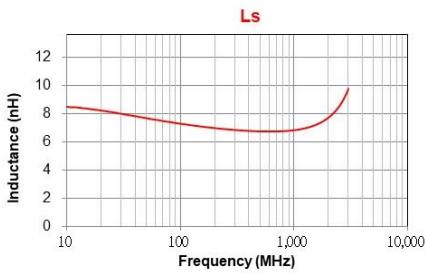

WLCM0603TG□7N5TB

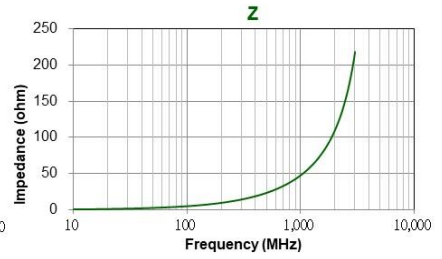
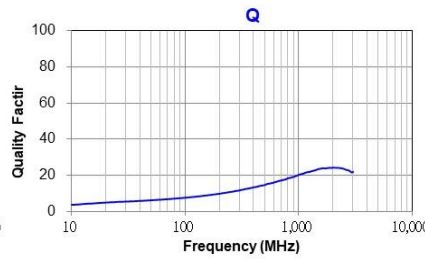
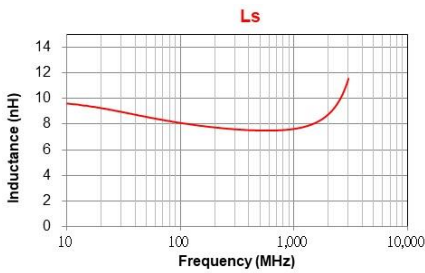

WLCM0603TG□8N2TB

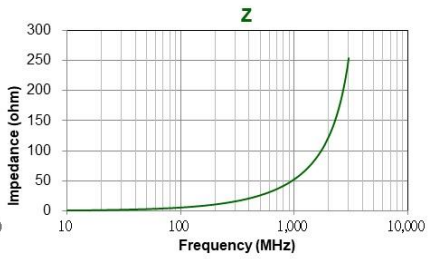
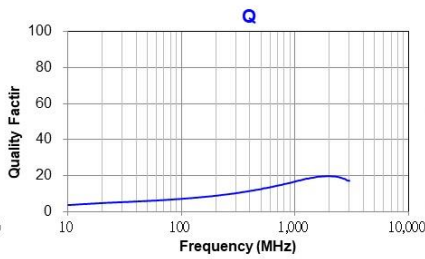
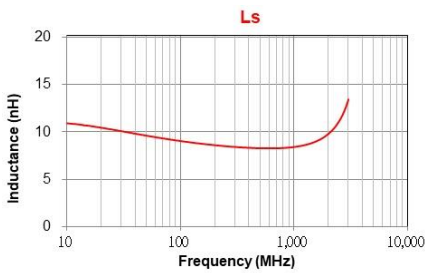

WLCM0603TG□9N1TB

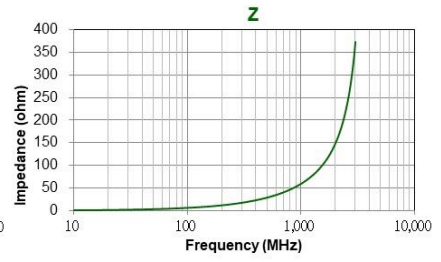
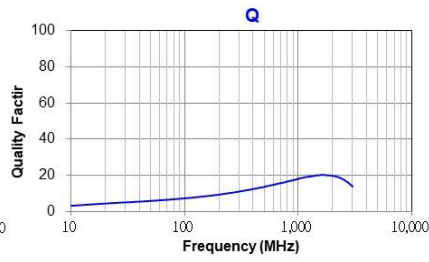
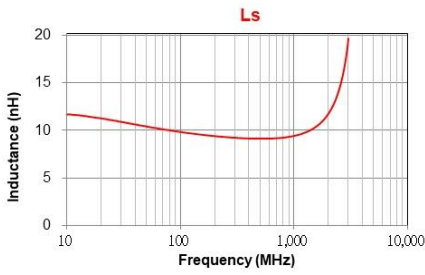

WLCM0603TG□10NTB

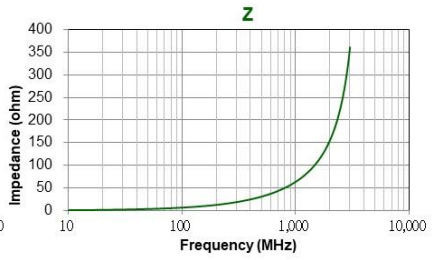
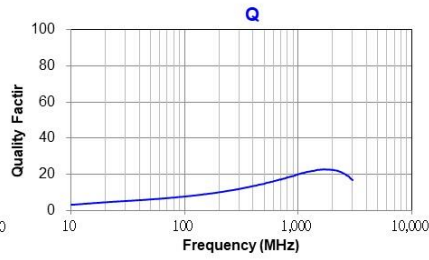
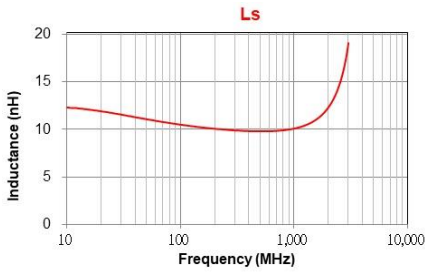

WLCM0603TG□12NTB

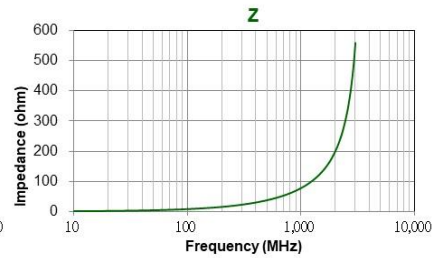
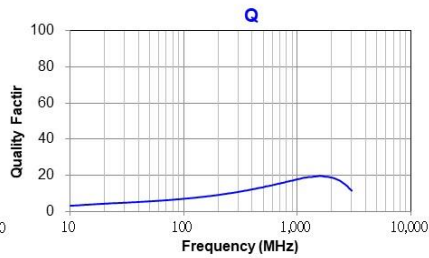
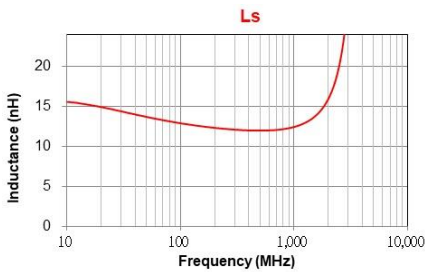

WLCM0603TG□15NTB

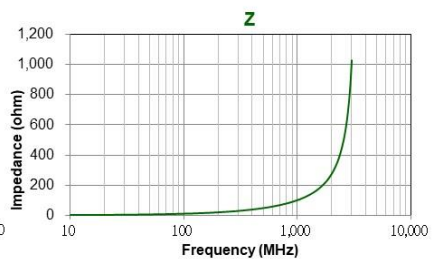
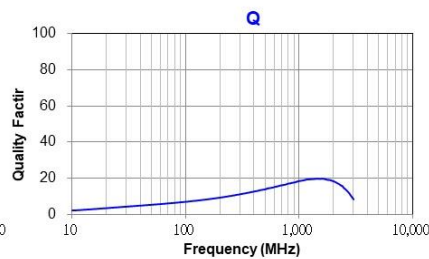
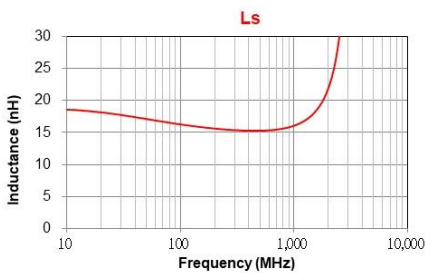

WLCM0603TG□18NTB

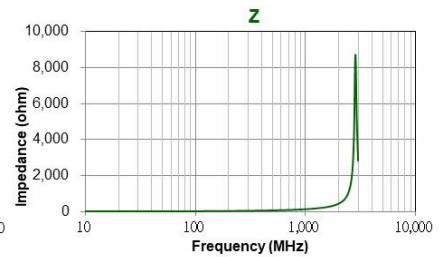
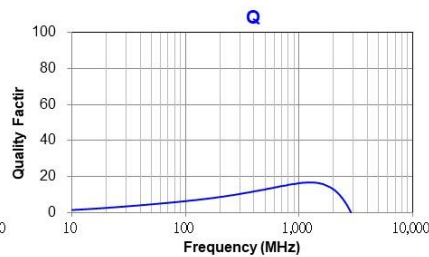
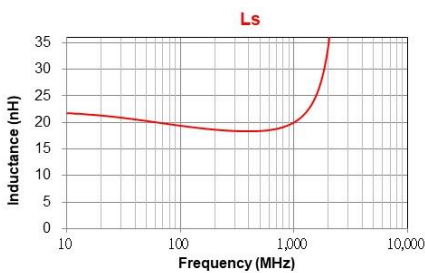

WLCM0603TG□22NTB

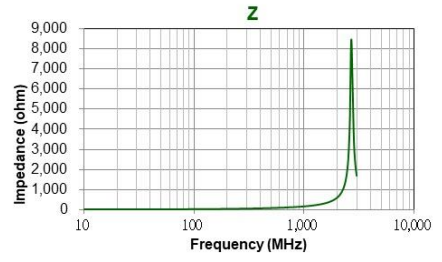
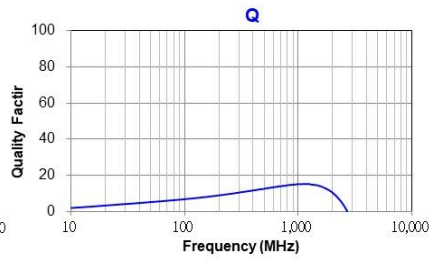
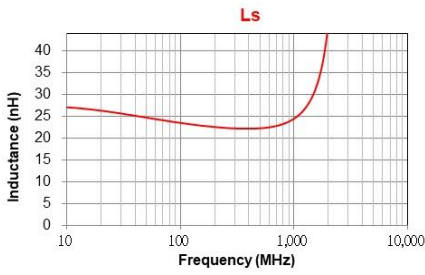

WLCM0603TG□27NTB

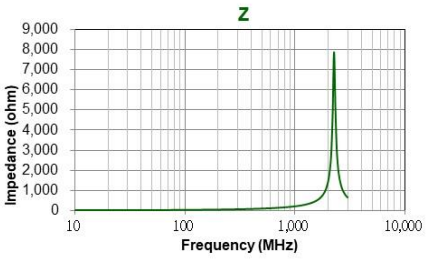
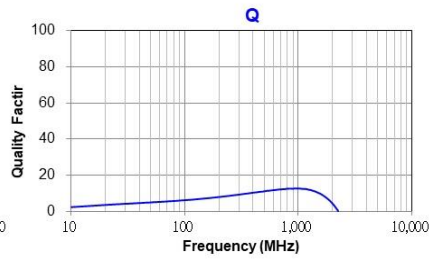
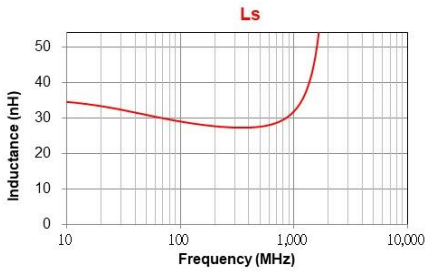

WLCM0603TG□33NTB

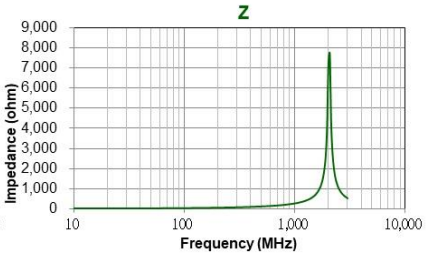
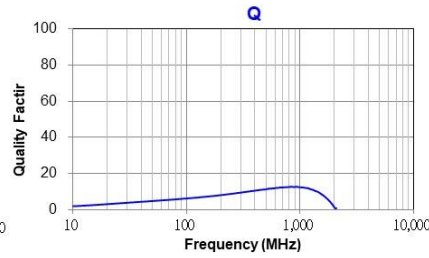
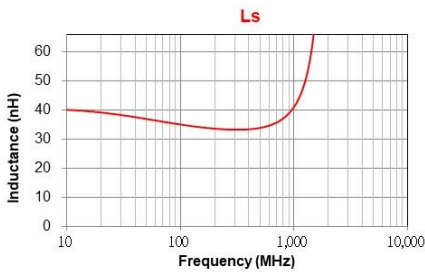

WLCM0603TG□39NTB

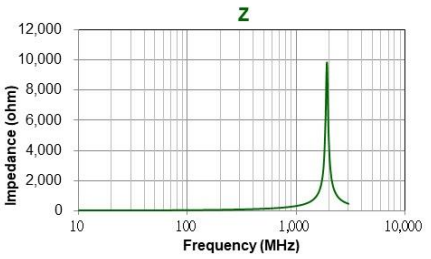
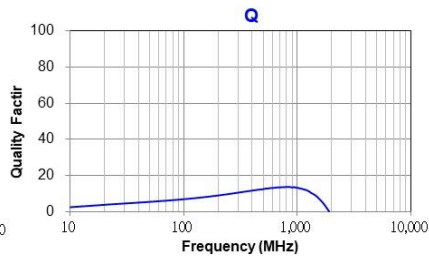
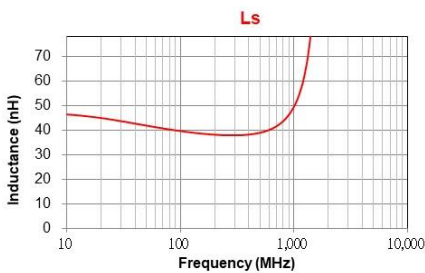

Test condition & Requirements (WLCM0603TG series)

Item	Test condition	Requirements
Temperature Cycle	<ol style="list-style-type: none"> 1. Temperature : -55 ~ +125°C 2. Cycle : 100 cycles 3. Dwell time : 30minutes 4. Measurement : at ambient temperature 24 hours after test completion 	<ol style="list-style-type: none"> 1. No mechanical damage 2. Inductance value should be within $\pm 10\%$ of the initial value 3. Q vale should be within $\pm 20\%$ of the initial value
Operational Life	<ol style="list-style-type: none"> 1. Temperature: 85 \pm 5°C 2. Testing time: 1000 hours 3. Applied current: Full rated current 4. Measurement: At ambient temperature 24 hours after test completion 	<ol style="list-style-type: none"> 1. No mechanical damage 2. Inductance value should be within $\pm 10\%$ of the initial value 3. Q vale should be within $\pm 20\%$ of the initial value
Biased Humidity	<ol style="list-style-type: none"> 1. Temperature : 40°C \pm 2°C 2. Humidity : 90 ~ 95 % RH 3. Test time : 1000 hours 4. Apply current : full rated current 5. Measurement : at ambient temperature 24 hours after test completion 	<ol style="list-style-type: none"> 1. No mechanical damage 2. Inductance value should be within $\pm 10\%$ of the initial value 3. Q vale should be within $\pm 20\%$ of the initial value
Resistance to Solder Heat	<ol style="list-style-type: none"> 1. Solder temperature : 260 \pm 5°C 2. Flux : Rosin 3. DIP time : 10 \pm 1 sec 	<ol style="list-style-type: none"> 1. More than 95 % of terminal electrode should be covered with new solder 2. Inductance value should be within $\pm 10\%$ of the initial value 3. Q vale should be within $\pm 20\%$ of the initial value
Solderability	<ol style="list-style-type: none"> 1. Solder temperature : 235 \pm 5°C 2. Flux : Rosin 3. DIP time : 5 \pm 1 sec 	<ol style="list-style-type: none"> 1. More than 95 % of terminal electrode should be covered with new solder 2. No mechanical damage

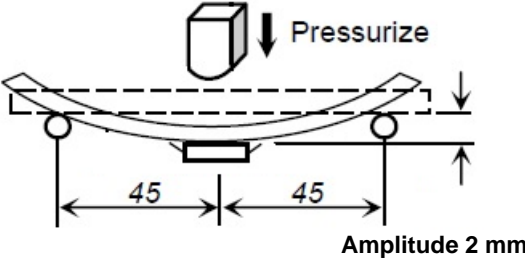
<p>Bending Strength</p>	<p>1. Solder the chip to test jig then apply a force in the direction shown in below.</p> <p>2. The soldering shall be done with the reflow method and shall be conducted with care so that the soldering is uniform and free of defects such as heat shock.</p> <div style="text-align: center;">  <p>Amplitude 2 mm</p> </div>	<p>No mechanical damage</p>
--------------------------------	--	-----------------------------

NOTE

The storage atmosphere must be free of gas containing sulfur and chlorine. Also, avoid exposing the product to saline moisture. If the product is exposed to such atmospheres, the terminals will oxidize and solderability will be affected.

GENERAL TECHNICAL DATA

Operating temperature range: - 55°C ~ +125°C
 Storage Condition: Less than 40°C and 70% RH
 Storage Time: 6 months Max.
 Soldering method: Reflow

TEST INSTRUMENTS CONDITIONS

Agilent E4991A RF Impedance Material Analyzer with fixture 16197A or equivalent
 Agilent 4338B Milliohm meter
 Test Level : 500 mV

Packaging Specification

Leader and Trailer Tape

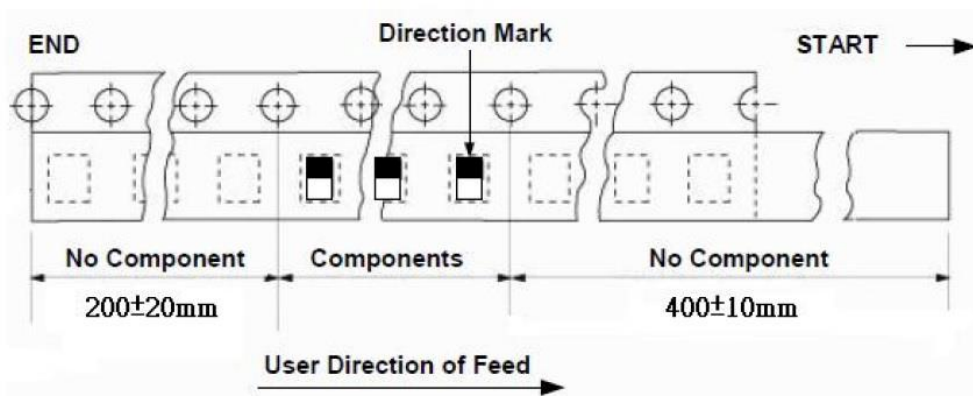

Paper Tape

Tape Dimension / 8mm

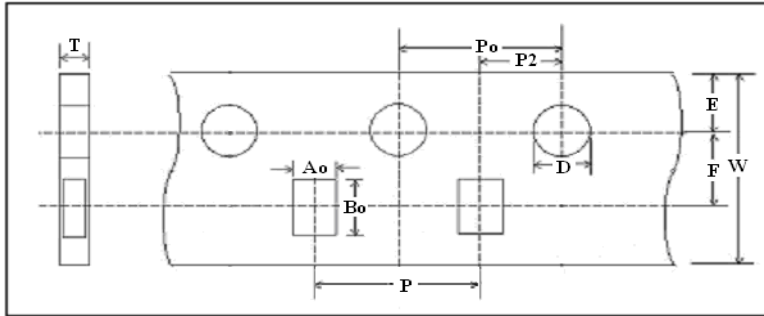

Taping Dimension

(mm)	0603
Symbol	PAPER
W	8.00 ± 0.30
P	2.00 ± 0.10
E	1.75 ± 0.05
F	3.50 ± 0.05
D	1.50 ~ 1.60
Po	4.00 ± 0.10
P2	2.00 ± 0.05
Ao	0.38 ± 0.02
Bo	0.68 ± 0.02
T	0.42 ± 0.02

REEL DIMENSION

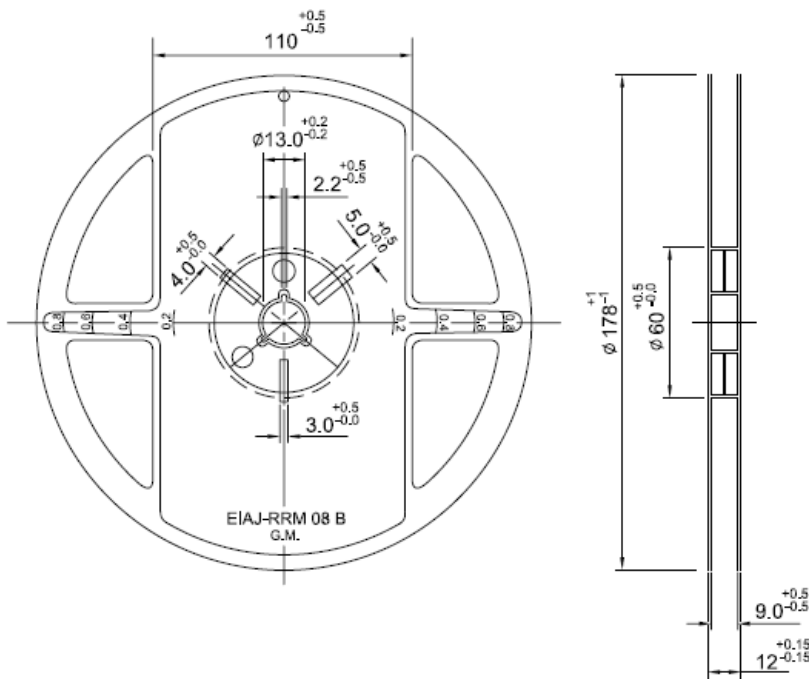

Unit : mm

7" Reel Packaging Quantity	
PART SIZE (EIA SIZE)	0603 (0201)
Qty.(pcs)	15,000
BOX	5 reels / inner box

RECOMMENDED SOLDERING CONDITIONS

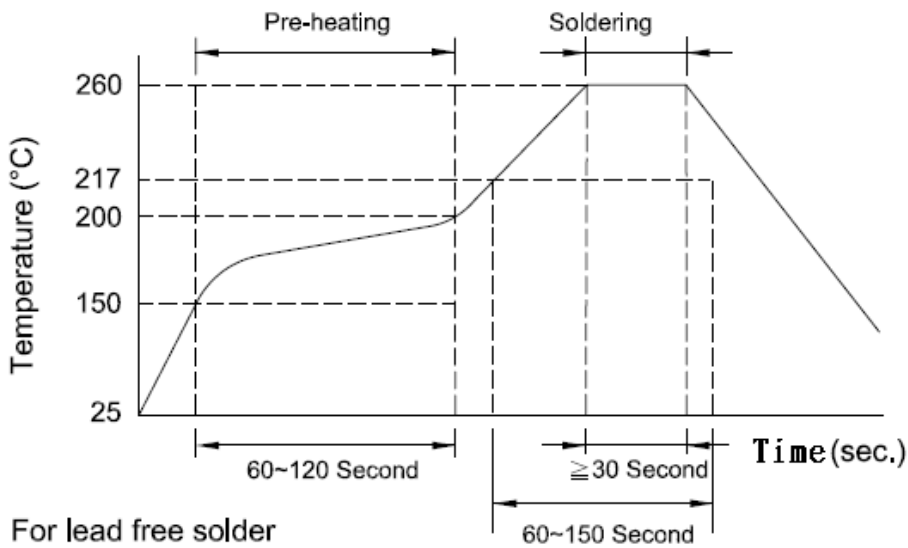

LAND PATTERNS REFLOW SOLDERING

Solder land information :

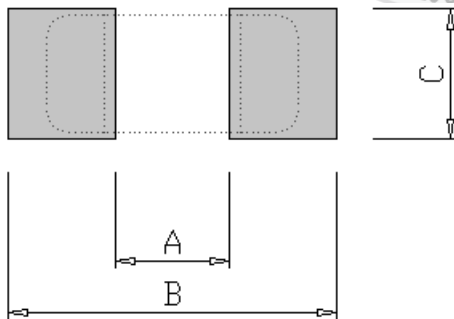

Size(mm)	A	B	C
0603 (EIA 0201)	0.20 ~ 0.30 (0.008 ~ 0.012)	0.80 ~ 0.90 (0.031 ~ 0.035)	0.20 ~ 0.30 (0.008 ~ 0.012)

单击下面可查看定价，库存，交付和生命周期等信息

[>>Walsin Technology\(华新科技\)](#)