

APPROVAL SHEET

**SF25T/U_Q, SF20T/U_Q, SF10T/U_Q,
SF12T/U_Q, SF08T/U_Q, SF06T/U_Q,
SF04T/U_Q.**

$\pm 1\%$, $\pm 0.5\%$, $\pm 0.25\%$, $\pm 0.1\%$, $\pm 0.05\%$

TC50, TC25

Anti-Sulfuration

High Precision Thin Film Chip Resistors

Size 2512, 2010, 1210, 1206, 0805, 0603, 0402.

AEC-Q200 Compliant.



*Contents in this sheet are subject to change without prior notice.

FEATURE

1. SMD metal film resistor
2. High reliability and stability of 0.3% and below per customer request
3. High performance of TCR: 50&25 ppm/°C and below per customer request
4. Low current noise
5. RoHS compliant and lead free
6. AEC-Q200 compliant
7. Sulfuration resistant against ASTM B-809-95*

APPLICATION

- Automotive
- Medical equipment
- Measuring instrument
- Communication devices
- Electronic devices

DESCRIPTION

The resistors are constructed in a high grade ceramic body (aluminum oxide). Internal metal electrodes are added at each end and connected by a resistive layer that is applied to the top surface of the substrate. The composition of the resistive layer is adjusted to give the approximate resistance required and the value is trimmed to nominated value within tolerance which controlled by laser trimming of this resistive layer.

The resistive layer is covered with a protective coat. Finally, the two external end terminations are added. For environmental soldering issue, the outer layer of these end terminations is a Lead-free solder .

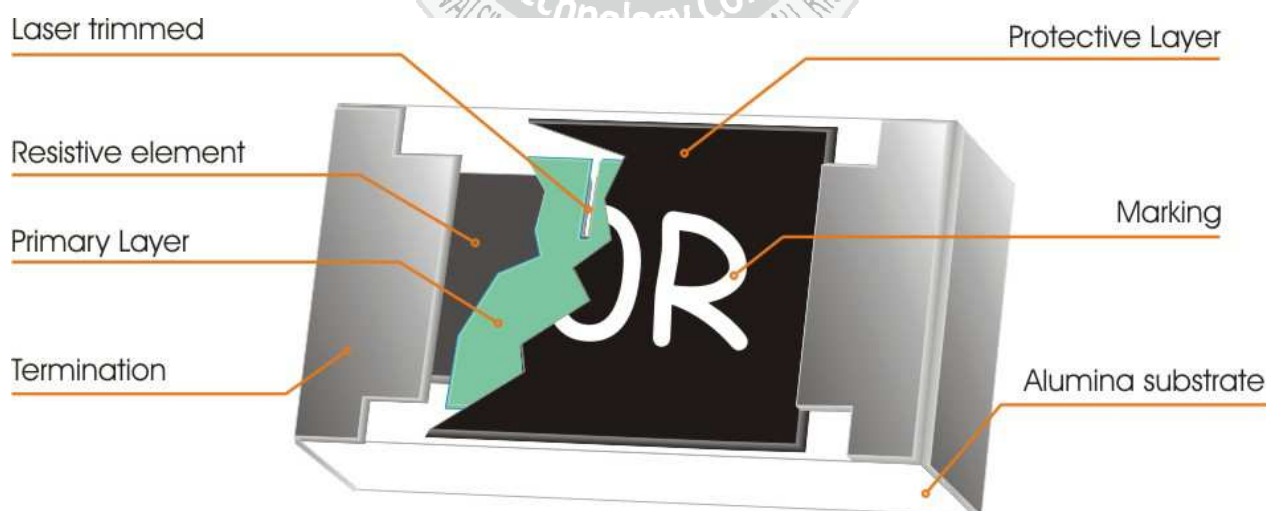

Fig 1. Construction of Chip-R SFxx_Q

QUICK REFERENCE DATA

Item	General Specification						
	SF25	SF20	SF10	SF12	SF08	SF06	SF04
Series No.	T&U_Q	T&U_Q	T&U_Q	T&U_Q	T&U_Q	T&U_Q	T&U_Q
Size Code	2512 (6432)	2010 (5025)	1210 (3225)	1206 (3216)	0805 (2012)	0603 (1608)	0402 (1005)
Resistance Tolerance	±1.0%, ±0.5%, ±0.25%, ±0.1%, ±0.05%						
Resistance Range	10Ω ~ 1.5MΩ	10Ω ~ 1.5MΩ	10Ω ~ 1MΩ	10Ω ~ 1MΩ	10Ω ~ 1MΩ	4.7Ω~ 330KΩ	10Ω ~ 100KΩ
TCR	±50 / 25 ppm/°C						
Max. Dissipation at T _{amb} =70°C	3/4W	1/2W	1/4W	1/8W	1/10W	1/16W	1/16W
Max. Operation Voltage	200V	200V	200V	200V	100V	50V	50V
Max. Overload Voltage	400V	400V	400V	400V	200V	100V	100V
Operating Temperature	-55~+155°C						

Note :

1. This is the maximum voltage that may be continuously supplied to the resistor element, see "IEC publication 60115-8"
2. Max. Operation Voltage : So called RCWV (Rated Continuous Working Voltage) is determined by

$$RCWV = \sqrt{\text{Rated Power} \times \text{Resistance Value}} \text{ or Max. RCWV listed above, whichever is lower.}$$

DIMENSIONS:(unit:mm)

Type	SF25_Q	SF20_Q	SF10_Q	SF12_Q	SF08_Q	SF06_Q	SF04_Q
L	6.35 ± 0.10	5.00 ± 0.10	3.10 ± 0.10	3.05 ± 0.15	2.00 ± 0.10	1.55 ± 0.10	1.00 ± 0.10
W	3.20 ± 0.15	2.50 ± 0.15	2.60 ± 0.15	1.55 ± 0.15	1.25 ± 0.10	0.80 ± 0.10	0.50 ± 0.05
A	0.60 ± 0.20	0.60 ± 0.20	0.50 ± 0.20	0.40 ± 0.20	0.25 ± 0.20	0.25 ± 0.15	0.30 ± 0.15
B	0.90 ± 0.25	0.60 ± 0.25	0.50 ± 0.20	0.40 ± 0.20	0.40 ± 0.20	0.30 ± 0.15	0.25 ± 0.10
t	0.55 ± 0.10	0.55 ± 0.10	0.55 ± 0.10	0.55 ± 0.10	0.50 ± 0.10	0.45 ± 0.10	0.35 ± 0.05

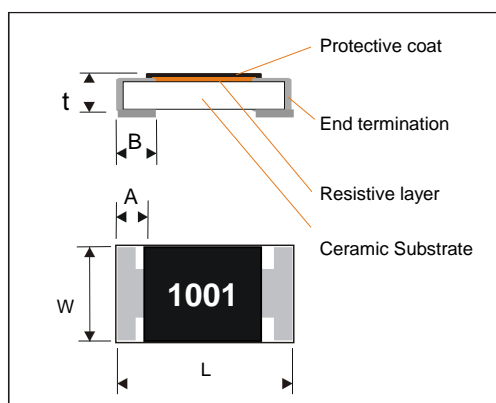

MARKING

- **3-digits marking for 0603 size**

SFxxT/U has same marking rule as WRxx ±1%.

Nominal resistance		Description													
1.E-24 series		As 0603 WR06X ±5%.													
2.E-96 series		The 1st two digit codes are referring to the CODE on the table, the 3rd code is the index of resistance value : Y=10 ⁻² , X=10 ⁻¹ , A=10 ⁰ , B=10 ¹ , C=10 ² , D=10 ³ , E=10 ⁴ , F=10 ⁵ EX: 17.8Ω=25X, 178Ω=25A, 1K78=25B 17K8=25C, 178K=25D, 1M78=25E													
3. Remark		There is no marking for the items are not under E-24 and E-96 series													
CODE	R_value	CODE	R_value	CODE	R_value	CODE	R_value	CODE	R_value	CODE	R_value	CODE	R_value	CODE	R_value
01	100	13	133	25	178	37	237	49	316	61	422	73	562	85	750
02	102	14	137	26	182	38	243	50	324	62	432	74	576	86	768
03	105	15	140	27	187	39	249	51	332	63	442	75	590	87	787
04	107	16	143	28	191	40	255	52	340	64	453	76	604	88	806
05	110	17	147	29	196	41	261	53	348	65	464	77	619	89	825
06	113	18	150	30	200	42	267	54	357	66	475	78	634	90	845
07	115	19	154	31	205	43	274	55	365	67	487	79	649	91	866
08	118	20	158	32	210	44	280	56	374	68	499	80	665	92	887
09	121	21	162	33	215	45	287	57	383	69	511	81	681	93	909
10	124	22	165	34	221	46	294	58	392	70	523	82	698	94	931
11	127	23	169	35	226	47	301	59	402	71	536	83	715	95	953
12	130	24	174	36	232	48	309	60	412	72	549	84	732	96	976

- **4-digits marking for 2512, 2010, 1210, 1206, 0805 size**

For E24+E96, each resistor is marked with a four digits code on the protective coating to designate the nominal resistance value. For values below 97Ω the R is used as a digit. For values of 100Ω or greater, the first 3 digits are significant, the fourth digit indicates the number of multiple to follow.

Example

RESISTANCE	100Ω	6800Ω	47000Ω
4-digits marking	1000	6801	4702

- **No marking code for 0402 and 0201 size**

FUNCTIONAL DESCRIPTION

Product characterization

Standard values of nominal resistance are taken from the E192 & E24 series for resistors with a tolerance of ±1.0%, ±0.5%, ±0.25%, ±0.1%, ±0.05%. The values of the E24/E192 series are in accordance with "IEC publication 60063".

DERATING:

The power that the resistor can dissipate depends on the operating temperature; see Fig.2

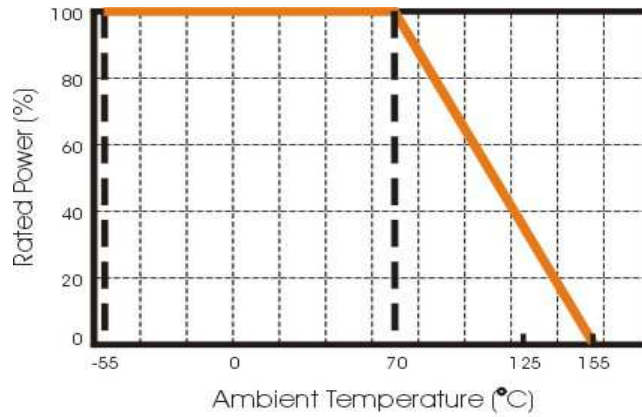

Fig.2 Maximum dissipation in percentage of rated power
As a function of the ambient temperature

MOUNTING

Due to their rectangular shapes and small tolerances, Surface Mountable Resistors are suitable for handling by automatic placement systems.

Chip placement can be on ceramic substrates and printed-circuit boards (PCBs).

Electrical connection to the circuit is by individual soldering condition.

The end terminations guarantee a reliable contact.

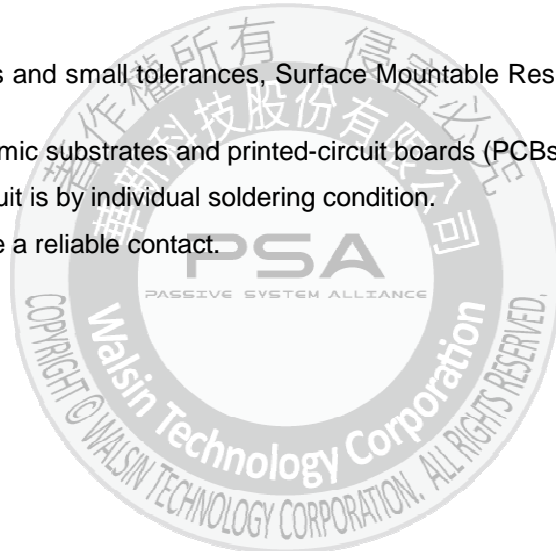

SOLDERING CONDITION

The robust construction of chip resistors allows them to be completely immersed in a solder bath of 260°C for 10 seconds. Therefore, it is possible to mount Surface Mount Resistors on one side of a PCB and other discrete components on the reverse (mixed PCBs).

Surface Mount Resistors are tested for solderability at 235°C during 2 seconds within lead-free solder bath. The test condition for no leaching is 260°C for 30 seconds. Typical examples of soldering profile and condition that provide reliable joints without any damage are given in Fig 3. and Table 1.

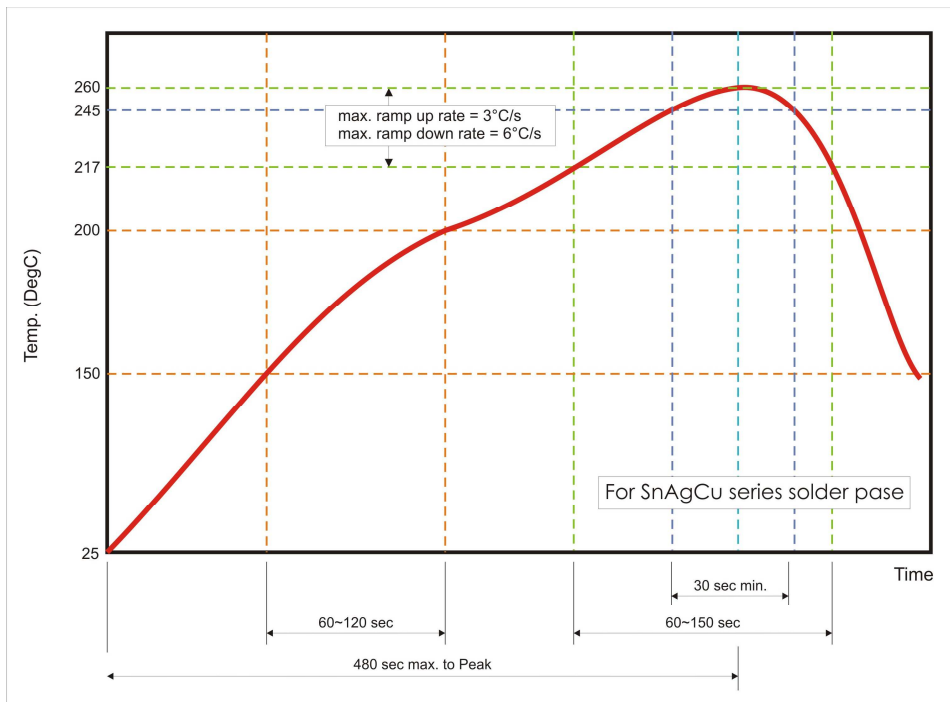

Fig. 3 Infrared soldering profile for Chip Resistors

Table 1. Infrared soldering condition for Chip Resistors

Temperature Condition	Exposure Time
Average ramp-up rate (217°C to 260°C)	Less than 3°C/second
Between 150 and 200°C	Between 60-120 seconds
> 217°C	Between 60-150 seconds
Peak Temperature	260°C +0/-5°C
Time within 245°C	Min. 30 seconds
Ramp-down rate (Peak to 217°C)	Less than 6°C/second
Time from 25°C to Peak	No greater than 480 seconds

CATALOGUE NUMBERS

The resistors have a catalogue number starting with .

SF06	T/U	xxxx	B	T	L	Q
Size code	Type code	Resistance code	Tolerance	Packaging code	Termination code	Special code
SF25: 2512	T: TCR = 50 ppm	R is first code	U : $\pm 0.02\%$	T : 7" Reel taping	L : lead free	Q : AEC-Q200
SF20: 2010	U: TCR = 25 ppm	followed by	A : $\pm 0.05\%$	A: 7" Reel 15k pcs		Compliant
SF10: 1210		3 significant digits.	B : $\pm 0.10\%$			
SF12: 1206		100 Ω =1000	C : $\pm 0.25\%$			
SF08: 0805		37.4K Ω =3742	D : $\pm 0.50\%$			
SF06: 0603			F : $\pm 1.00\%$			
SF04: 0402						

- Reeled tape packaging: 8mm width paper taping.
5,000pcs/reel for SF10_Q, SF12_Q, SF08_Q, SF06_Q,
10,000pcs/reel for SF04_Q;
- Reeled tape packaging: 12mm width paper taping
4,000pcs/reel for SF25_Q, SF20_Q.



TEST AND REQUIREMENTS

TEST	PROCEDURE	REQUIREMENT
		Resistor
Electrical Characteristics IEC 60115-1 4.8	- DC resistance values measurement - Temperature Coefficient of Resistance (T.C.R) Natural resistance change per change in degree centigrade. $\frac{R_2 - R_1}{R_1(t_2 - t_1)} \times 10^6 \text{ (ppm/ } ^\circ\text{C)}$ $t_1 : 20^\circ\text{C} \pm 5^\circ\text{C} - 1^\circ\text{C}$ R_1 : Resistance at reference temperature ($20^\circ\text{C} \pm 5^\circ\text{C} - 1^\circ\text{C}$) R_2 : Resistance at test temperature (-55°C or $+125^\circ\text{C}$)	Within the specified tolerance
Short time overload (S.T.O.L) IEC60115-1 4.13	Permanent resistance change after a 5second application of a voltage 2.5 times RCWV or the maximum overload voltage specified in the above list, whichever is less.	R/R max. $\pm(0.1\%+0.05\Omega)$
Resistance to soldering heat(R.S.H) AEC Q200-15	Un-mounted chips completely immersed for 10 ± 1 second in a SAC solder bath at $260^\circ\text{C} \pm 5^\circ\text{C}$	no visible damage R/R max. $\pm(0.2\%+0.05\Omega)$
Solderability IEC 60068-2-58	Un-mounted chips completely immersed for 2 ± 0.5 second in a SAC solder bath at $235^\circ\text{C} \pm 5^\circ\text{C}$	good tinning (>95% covered) no visible damage
Temperature cycling MIL-STD-202 Method 107	Test -55 to 125°C / dwell time 30min/ Max transfer time 20sec 1000 cycles	no visible damage R/R max. $\pm(0.3\%+0.05\Omega)$
Biased Humidity MIL-STD-202 Method 103	Test 1000 hours/ at $85^\circ\text{C}/85\%$ RH./ 10% of operation power. Measurement at 24 ± 4 hours after test conclusion	R/R max. $(0.3\%+0.05\Omega)$
Operational Life MIL-STD-202 -108	1000 hours at $125 \pm 2^\circ\text{C}$, loaded with rated power continuously	R/R max. $(0.3\%+0.05\Omega)$
High Temperature Exposure MIL-STD-202-108	1000 hours at 155°C , un-powered	R/R max. $(0.3\%+0.05\Omega)$
Mechanical Shock MIL-STD-202 Method 213	1/2 Sine Pulse / 100g Peak / Velocity 12.3ft/sec	R/R max. $(0.25\%+0.05\Omega)$
Vibration MIL-STD-202 Method 204	5 g's for 20 min , 12 cycles each of 3 orientations	R/R max. $(0.1\%+0.05\Omega)$
Terminal strength AEC-Q200-006	1kg for 60 s	No broken
Board flex AEC-Q200-005	Bending 2mm for 60 sec	R/R max. $(0.1\%+0.05\Omega)$
Flower of Sulfur ASTM-B-809-95* * Modified	Sulfur 1000 hours, 105°C , unpowered	R/R max. $(4\%+0.05\Omega)$

PACKAGING

Paper Tape specifications (unit :mm)

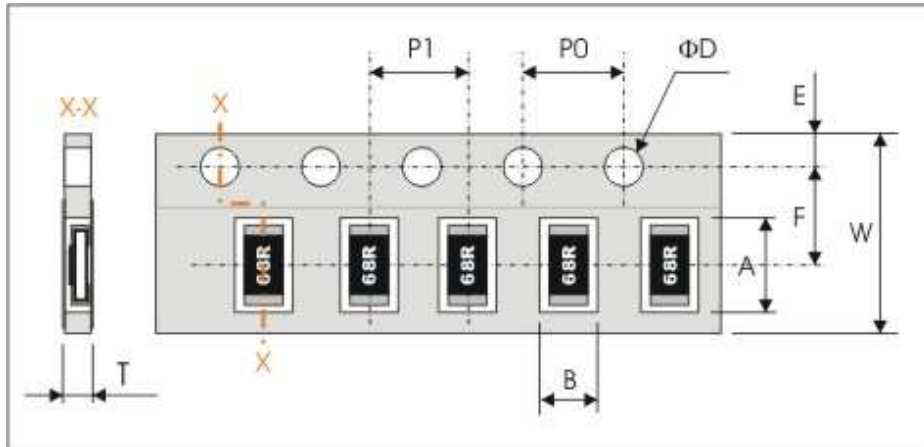

Series No.	Tape	A	B	W	D	E
SF25	Plastic	6.90±0.20	3.60±0.20	12.00±0.30	5.50±0.10	1.75±0.10
SF20	Plastic	5.50±0.20	2.80±0.20	12.00±0.30	5.50±0.10	1.75±0.10
SF12	Paper	3.60±0.20	2.00±0.20	8.00±0.30	3.50±0.20	1.75±0.10
SF10	Paper	3.60±0.20	3.00±0.20	8.00±0.30	3.50±0.20	1.75±0.10
SF08	Paper	2.40±0.20	1.65±0.20	8.00±0.30	3.50±0.20	1.75±0.10
SF06	Paper	1.90±0.20	1.10±0.20	8.00±0.30	3.50±0.20	1.75±0.10
SF04	Paper	1.20±0.10	0.7±0.10	8.00±0.20	3.50±0.05	1.75±0.10

Series No.	F	P0	ΦD	T
SF25	4.00±0.10	4.00±0.10	Φ1.50 ^{+0.1} _{-0.0}	Max 1.2
SF20	4.00±0.10	4.00±0.10	Φ1.50 ^{+0.1} _{-0.0}	Max 1.2
SF12	4.00±0.10	4.00±0.10	Φ1.50 ^{+0.1} _{-0.0}	Max. 1.0
SF10	4.00±0.10	4.00±0.10	Φ1.50 ^{+0.1} _{-0.0}	Max. 1.0
SF08	4.00±0.10	4.00±0.10	Φ1.50 ^{+0.1} _{-0.0}	Max. 1.0
SF06	4.00±0.10	4.00±0.10	Φ1.50 ^{+0.1} _{-0.0}	0.65±0.05
SF04	2.00±0.10	4.00±0.10	Φ1.50 ^{+0.1} _{-0.0}	0.40±0.05

Reel dimensions

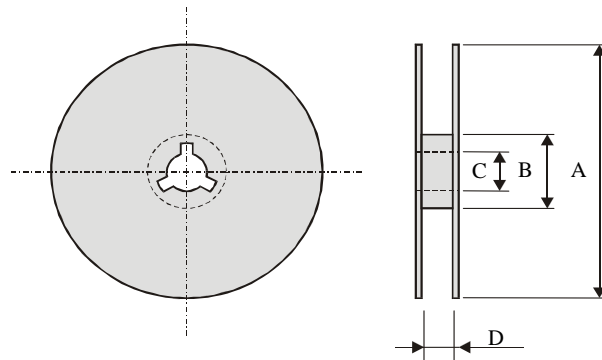

SF25 , SF20

Symbol	A	B	C	D
(unit : mm)	$\Phi 178.0 \pm 2.0$	$\Phi 60.0 \pm 1.0$	13.0 ± 0.2	14.0 ± 0.5

SF12 , SF10 , SF08 , SF06 , SF04

Symbol	A	B	C	D
(unit : mm)	$\Phi 178.0 \pm 2.0$	$\Phi 60.0 \pm 1.0$	13.0 ± 0.2	9.0 ± 0.5

Taping quantity

- Chip resistors 4,000 pcs per reel (SF25_Q, SF20_Q)
- Chip resistors 5,000 pcs per reel (SF10_Q, SF12_Q, SF08_Q, SF06_Q)
- Chip resistors 10,000 pcs per reel (SF04_Q)

单击下面可查看定价，库存，交付和生命周期等信息

[>>Walsin Technology\(华新科技\(华科\)\)](#)

[>>点击查看相关商品](#)