

1. 適用範圍 / SCOPE

此份規格書涵蓋 MSH2512 系列金屬板電流感測電阻元件相關規格。

This specification covers MSH2512 series devices, which are Metal Strap Current Sensing Resistor.

2. 產品型號 / TYPE NUMBER

MSH2512	N	xWx	Rxxx	*
(1)	(2)	(3)	(4)	(5)

- (1) 產品系列號 / Series number : MSH2512 = 純金屬 / pure metal ; 短電極 / short electrode ; 兩端子 & 高功率 / two terminal & high power 尺寸 / size “0.25×0.12”
- (2) 產品材質 / Material : N = 合金 / alloy
- (3) 產品瓦特數 / Power Rating : 2W0=2.0 Watt ; 3W0=3.0 Watt
- (4) 產品阻值 / Nominal Resistance Value : 1mΩ → R001 ; 5mΩ → R005 ; 10mΩ → R010
- (5) 元件電阻偏差值 / Resistance Tolerance : F=±1% ; G =±2% ; H=±3% ; J=±5%

3. 產品尺寸 / PRODUCT DIMENSIONS



圖 1 / Fig.1

Part Number	W	L	T	A
MSH2512N2W0-series R001~R010	3.20±0.20	6.40±0.20	1.20±0.2	0.80±0.20
MSH2512N3W0-series R001~R010	3.20±0.20	6.40±0.20	1.20±0.2	0.80±0.20

4. 產品結構及使用材料說明 (參考圖 2) / STRUCTURE & MATERIAL (Ref to Fig.2)

圖 2 / Fig.2

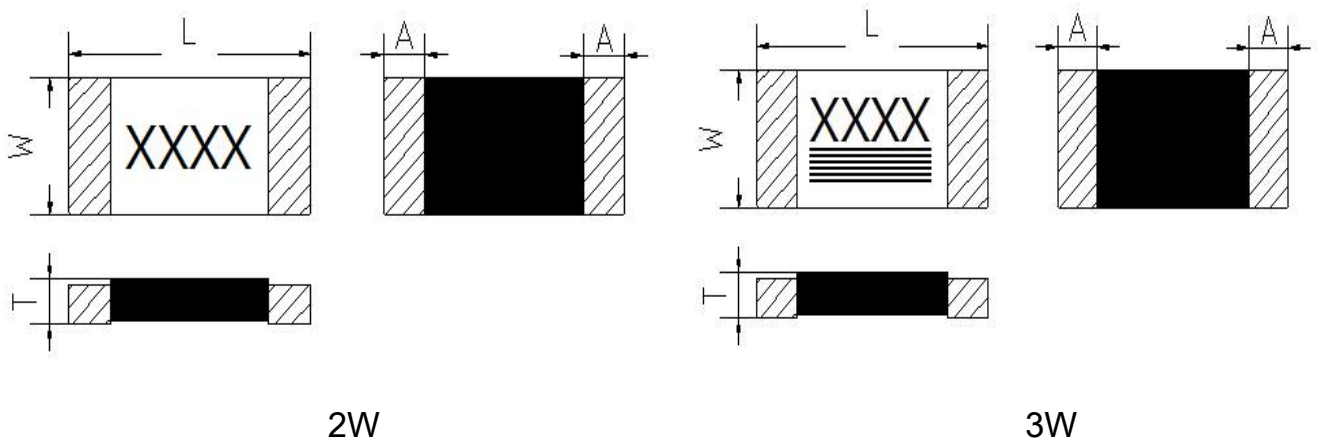
4.1 電阻本體 / Resistive element(1) : 合金 / metal – alloy

4.2 端電極 / Terminal electrode(3) : 鎳、錫 / Ni、Sn

 4.3 保護防焊層 / Protective coating(2) : 防火級環氧樹脂,符合 UL- 94-V0 要求(黑色)/
 Flame-retardant epoxy, meets UL- 94-V0 requirements (black)

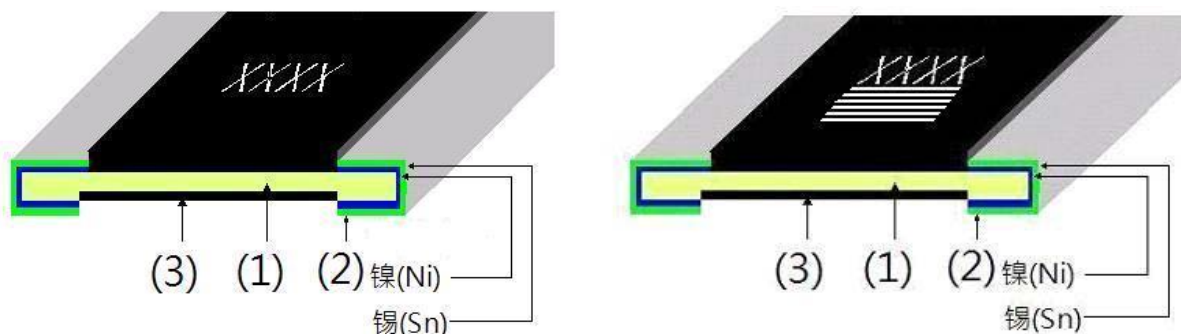
5. 產品特性及信賴性測試規範 / PRODUCT CHARACTERISTICS AND RELIABILITY TEST STANDARD

測試方法 Parameter	條件 Conditions	允收標準 Requirements
瞬間過載測試 / Short Time Over Load	2W : R001 :P= 3Pr ; T=25±2°C , t = 5sec. R002~ R010 :P= 5Pr ; T=25±2°C , t = 5sec. 3W : P= 3Pr ; T=25±2°C , t = 5sec.	±(1.0%+0.5mΩ) IEC60115-1 4.13
高溫測試 / High Temp. Exposure	T = +170±2°C ; t = 1000h	±(1.0%+0.5mΩ) IEC60115-1 4.25
低溫測試 / Low Temp. Storage	T = -55±2°C ; t = 1000h	±(1.0%+0.5mΩ) IEC60115-1 4.25
濕度負載壽命測試 / Moisture Load Life (60°C、95%RH)	Vtest = Vmax ; T=60±2°C ; RH=95% ; t= 90min ON , 30min OFF , 1000h	±(2.0%+0.5mΩ) IEC60115-1 4.25
冷熱衝擊測試 / Thermal Shock	[-55°C 30min. → R.T. 3min. → +150°C 30min. → R.T. 3min], 100個連續循環 / 100Cycles	±(1.0%+0.5mΩ) IEC60115-1 4.19
在70°C下負載壽命測試 / Load Life at 70°C	Vtest = Vmax ; T=70±2°C ;t= 90min ON , 30min OFF,1000h	±(2%+0.5mΩ) IEC60115-1 4.25
可焊性測試 / Solderability	浸入錫爐 / Dip into solder at T = 245±5°C , t = 3±0.5sec.	錫涵蓋面積/The covered area >95% IEC60115-1 4.17
抗焊熱性測試 / Resistance to Solder Heat	經熱風式迴焊爐 / Through Reflow T= 265±5°C , t =20±1sec.	±(1.0%+0.5mΩ) IEC60115-1 4.18
機械衝擊測試 / Mechanical Shock	加速度a =100G , 振幅時間t =11ms, 5個衝擊 a =100G , t =11ms, 5 times shock	±(1.0%+0.5mΩ) IEC60115-1 4.21
基板彎曲測試 / Substrate Bending	兩支撐點間距 / Span between fulcrums : 90mm ; 振幅 / Bend Width : 2mm ; 測試板/Test board : 玻璃纖維板/ Glass-Epoxy Board ;厚度 / Thickness =1.6mm	±(1.0%+0.5mΩ) IEC60115-1 4.33

6. 電氣特性 / ELECTRICAL CHARACTERISTICS

Part Number	Resistance Value (mΩ)	Power Rating (Watt)	Resistance Tolerance (%)	TCR (ppm)
MSH2512N2W0-series R001~R010	1~3	2	±1%(F)	±100
	4~10			±75

Part Number	Resistance Value (mΩ)	Power Rating (Watt)	Resistance Tolerance (%)	TCR (ppm)
MSH2512N3W0-series R001~R010	1~3	3	±1%(F)	±100
	4~10			±75

7. 環境特性 / ENVIRONMENTAL CHARACTERISTIC

7-1 操作溫度範圍: -55°C ~ 170°C / Operating Temperature: -55°C ~ 170°C

額定功率溫度衰變曲線 / Typical Thermal Derating Curve

額定功率乃指於 70 °C 以內可連續滿額功率使用的術語。

下圖為當操作溫度高於 70°C 時的可使用功率衰減曲線。

Power rating is based on continuous full load operation at rated ambient temperature of 70 °C. For resistors operated at ambient temp. in excess of 70 °C, the max. load shall be derated in accordance with the following curve.

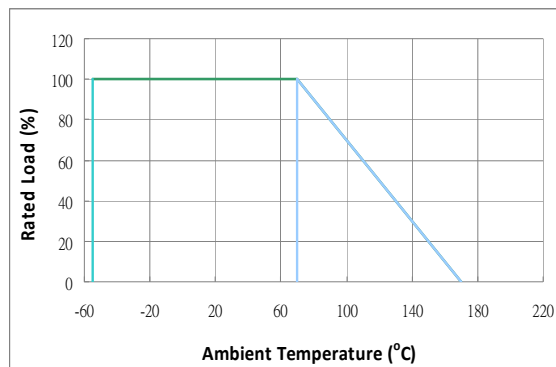

7-2 存儲條件 / STORAGE CONDITIONS

在溫度+10°C ~ 40°C、相對濕度 ≤ 75% 的密閉條件下可存放2年。 /

Under airtight in temperature +10°C ~ 40°C、relative humidity ≤ 75% can store 2 years.

在溫度+10°C ~ 60°C、相對濕度為95% 的非露天下最多可存放30 天。 /

Without dew in temperature +10°C ~ 60°C、relative humidity be 95% maximum value for 30days.

8. 焊錫墊尺寸及焊接條件 / SOLDER PAD SIZE AND WELDING CONDITIONS

8-1 建議如下圖焊接方式焊接，並滿足所要求的尺寸。 / Propose that the following picture installation way is installed, and satisfied the required size.

Part Number	P	W	D	t	Loading
MSH2512N2W0-series R001~R010	3.18mm	3.57mm	2.11mm	105 μ	2.0W

Part Number	P	W	D	t	Loading
MSH2512N3W0-series R001~R010	3.18mm	3.57mm	2.11mm	105 μ	3.0W

t : 元件焊墊金屬層厚度 (min.) / Thickness of pad metal (min.)

loading : 適用於本司建議焊墊設計並使用於限定穩定電流下 /
suit for specific pad layout and specific steady current

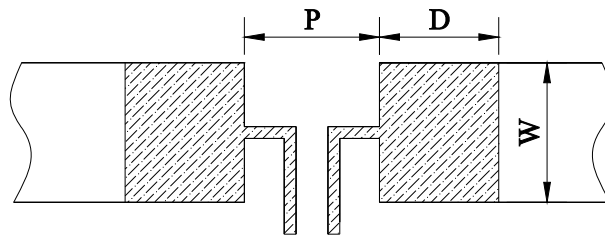

8-2 建議客戶焊接參數 / Recommended Customer Soldering Parameters

8-2-1 波峰焊溫度曲線 / Wave solder Temperature condition (圖 3 / Fig.3)

預熱段 / Preheating : 100°C~130°C, max.100 sec.

焊錫段 / Soldering: 250°C~265°C max. 10 sec.

允許最高溫度 / Maximum temperature : 260±5°C, max. 10sec.



圖 3 / Fig.3

8-2-2 回流焊溫度曲線 / Solder reflow Temperature condition (圖 4 / Fig.4)

預熱段 / Preheating : 145 ± 15°C, max.120 sec.

焊錫段 / Soldering : min. 220°C, max. 60 sec.

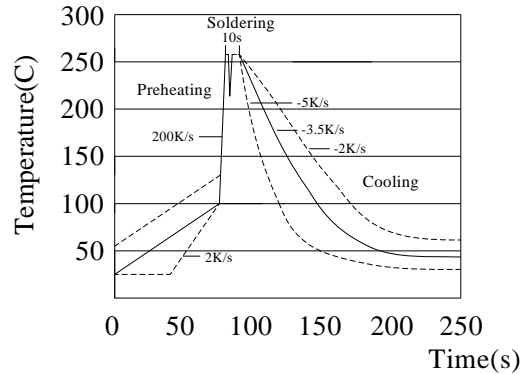
允許最高溫度 / Maximum temperature : 260±5°C, max. 10sec.



圖4 / Fig.4

8-2-3 允許烙鐵焊接條件(熱風設備) / Rework temperature (hot air equipment) : 350°C, 3~5seconds

8-2-4 焊接方法建議 / Recommended reflow methods

焊接熱源方式可用紅外線, 熱蒸氣, 熱風. / IR, vapor phase oven, hot air oven

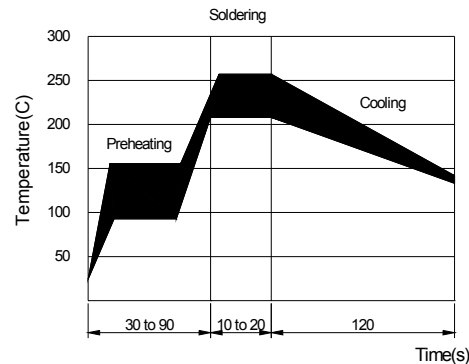
如果焊錫溫度超過允許最高溫度, 則產品本身會有功能損壞的疑慮. / If reflow temperatures exceed the recommended profile, devices may not meet the performance requirements.

9. 批量生產後出貨測試項目 / Lot ACCEPTANCE TEST REQUIREMENTS

9-1 外觀 / Visual

方法 / Procedure : 利用放大鏡進行檢查 / Visual

標準 / Acceptance Criteria : 不能有髒污、不潔、文印錯誤、破損等 / No parts are outstandingly stained

9-2 尺寸 / Dimensions

方法 / Procedure : 使用合適且經校正的尺規 / As appropriate, calipers, micrometers, optical comparator, or approved gages

標準 / Acceptance Criteria : 尺寸均在規定標準範圍內 / No parts outside specific dimensions

9-3 單體元件電阻(Ro) / Resistance (Ro)

方法 / Procedure : 在 25°C 下利用四線量測技術量測之 / Resistance shall be measured with 25 °C in the 4-wire resistance test

標準 / Acceptance Criteria : 電阻值均在規定標準範圍內 / The resistance of the test device shall be within the limits specified

9-4 電阻溫度係數 / TCR

方法 / Procedure : 利用四線法量測出元件分別在 25°C 及 125°C 下的電阻值, 並將其帶入下面公式中即可得出 TCR 值 / Getting the sampling device resistance values measured in 25°C and 125°C and put them in to the following equation to calculate the TCR

標準 / Acceptance Criteria : 溫度係數值均在規定標準範圍內 / All parts must within the specific $TCR = (R_b - R_a) / R_a \times 1 / (T_b - T_a) \times 10^6$

9-5 絕緣電阻 / Insulation resistance (Ri)

方法 / Procedure : 利用絕緣測試儀量測 / Resistance between protective layer and resistive shall be measured by high ohm meter

標準 / Acceptance Criteria : 防焊層與電阻本體絕緣電阻至少高於 100MΩ / The resistance of the test device shall over 100MΩ

10. 包裝訊息 / PACKAGING INFORMATION

10-1 包裝數量、重量 / QUANTITY & WEIGHT

型號 / Type Number	數量 / Quantity (pcs)	重量 / Weight (g)
MSH2512N2W0-series	1,500	265±25
MSH2512N3W0-series	1,500	265±25

10-2 捲輪規格 / Reel & Tape specifications

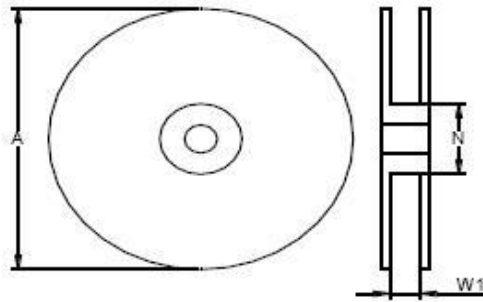

型號 / Type Number	A±5 (mm)	N±2 (mm)	W1±1 (mm)
MSH2512N2W0-series	178	60	13
MSH2512N3W0-series	178	60	13

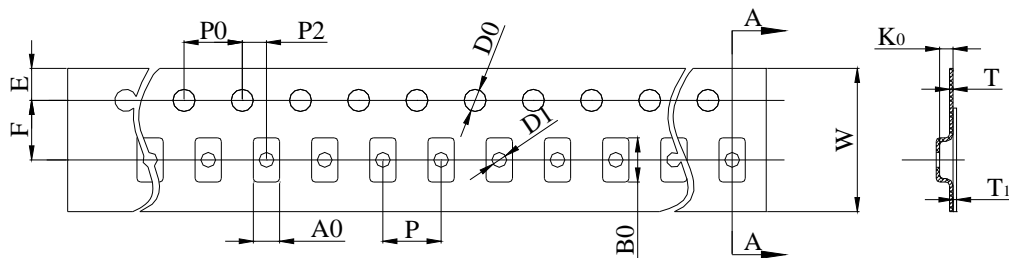

MSH2512N2W0-series							
W	12.00 ± 0.30	P0	4.00 ± 0.10	P	8.00 ± 0.10	P2	2.00 ± 0.10
A0	3.90 ± 0.20	B0	6.75 ± 0.20	D0	1.55 ± 0.10	F	5.50 ± 0.10
E	1.75 ± 0.10	T	0.25 ± 0.10	T1	Max. 0.1	K0	1.50 -0.10/+0.2

10-3 密封膠膜剝離強度要求 / Peeling Strength of Seal Tape

F = 剝離強度 : 0.1 – 1.0N (10 - 100gf)

F = Peeling Strength: 0.1 – 1.0N (10 - 100gf)

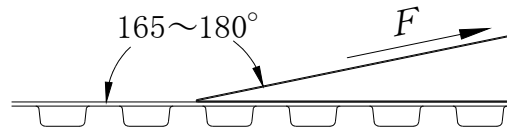

11. 其他 / OTHERS

11-1 如果在使用中有超出本規格書的要求，必須經由雙方協商確認。 / In the event that an impropriety is found beyond this specification ,it shall be fixed by mutual agreement between the parties.

11-2 如果本規格書有不適當的情況，必須通過雙方協商並由本公司修改。 / In the event that an impropriety is found in this specification , WALTER ELECTRONIC CO., LTD. shall amend it by mutual agreement between the parties.

单击下面可查看定价，库存，交付和生命周期等信息

[>>Walter\(华德\)](#)