



# WS5414KC

## Transient Voltage Suppressor

### Features

- Solid-state silicon-avalanche technology
- Low operating and clamping voltage
- Up to four I/O Lines of Protection
- Low operating voltage:5V
- Flow-Through design

### IEC COMPATIBILITY (EN61000-4)

- IEC 61000-4-2 (ESD) ±15kV (air), ±12kV (contact)
- IEC 61000-4-4 (EFT) 40A (5/50ns)
- IEC 61000-4-5 (Lightning) 4.5A (8/20µs)

### Mechanical Characteristics

- DFN-10L package (2.5x1.0x0.50mm)
- Marking: Marking Code
- Packaging: Tape and Reel
- RoHS Compliant & HF

### Applications

- Digital Visual Interface(DVI)
- MDDI Ports
- DisplayPort TM Interface
- PCI Express
- High Definition Multi-Media Interface(HDMI)

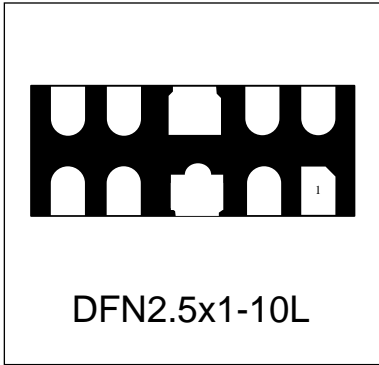

### Circuit Diagram

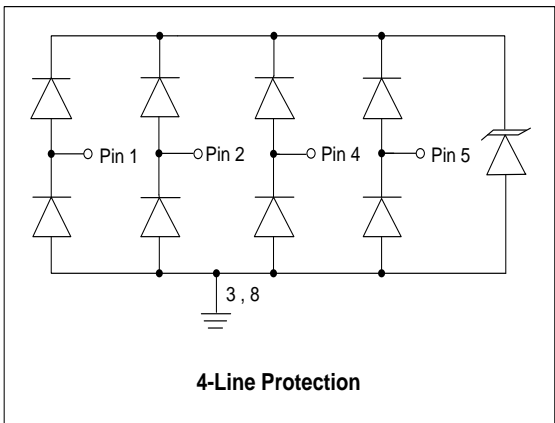

### Schematic & Pin Configuration

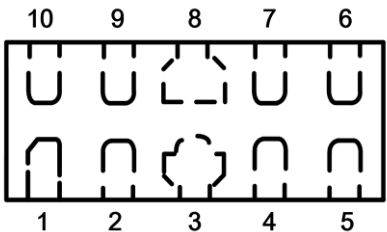

Pin	Identificaion
1,2,4,5	Input Lines
6,7,9,10	Output Lines (No Internal Connection)
3,8	Ground

### Absolute Maximum Rating

Rating	Symbol	Value	Units
Peak Pulse Power ( $t_p = 8/20\mu s$ )	$P_{PP}$	45	Watts
Peak Pulse Current ( $t_p = 8/20\mu s$ )	$I_{PP}$	4.5	A
Operating Temperature	$T_J$	-55 to + 125	°C
Storage Temperature	$T_{STG}$	-55 to +150	°C

### Electrical Parameters

Symbol	Parameter
$I_{PP}$	Reverse Peak Pulse Current
$V_C$	Clamping Voltage @ $I_{PP}$
$V_{RWM}$	Reverse Stand-Off Voltage
$I_R$	Reverse Leakage Current @ $V_{RWM}$
$V_{BR}$	Breakdown Voltage @ $I_T$
$I_T$	Test Current
$I_F$	Forward Current
$V_F$	Forward Voltage @ $I_F$

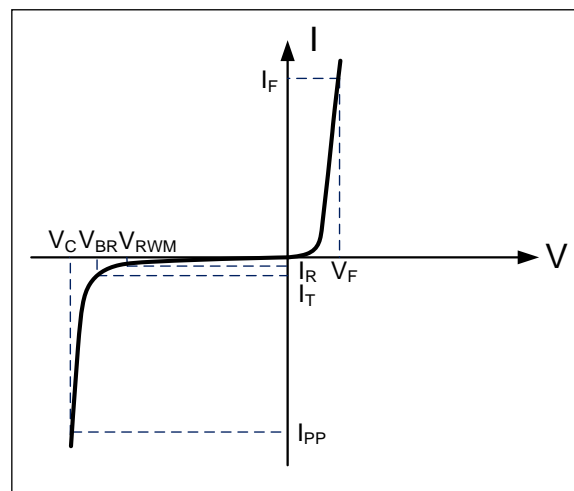

### Electrical Characteristics(T=25°C unless otherwise noted)

Parameter	Symbol	Conditions	Minimum	Typical	Maximum	Units
Reverse Stand-Off Voltage	$V_{RWM}$	Any I/O pin to ground			5	V
Reverse Breakdown Voltage	$V_{BR}$	$I_T = 1mA$ Any I/O pin to ground	6			V
Reverse Leakage Current	$I_R$	$V_{RWM} = 5V$ , Any I/O pin to ground			500	nA
Clamping Voltage	$V_C$	$I_{PP} = 1A$ , $t_p = 8/20\mu s$ Any I/O pin to ground			8	V
Clamping Voltage	$V_C$	$I_{PP} = 4.5A$ , $t_p = 8/20\mu s$ Any I/O pin to ground		8	10	V
Dynamic Resistance <sup>1,2</sup>	$R_{DYN}$	TLP=0.2/100ns		0.3		Ω
ESD Clamping Voltage <sup>1</sup>	$V_C$	$I_{PP} = 4A$ , $t_p = 0.2/100ns$ (TLP)		7.8		V
ESD Clamping Voltage <sup>1</sup>	$V_C$	$I_{PP} = 16A$ , $t_p = 0.2/100ns$ (TLP)		11.5		V
Junction Capacitance	$C_j$	$V_{pin-3,-8} = 0V$ , $V_R = 2.5V$ , $f = 1MHz$ Any I/O pin to GND		0.5	0.65	pF
Junction Capacitance	$C_j$	$V_{pin-3,-8} = 0V$ , $V_R = 2.5V$ , $f = 1MHz$ Between I/O pin		0.04	0.08	pF

Notes : 1、 TLP Setting :  $t_p = 100ns$ ,  $t_r = 0.2ns$ ,  $I_{TLP}$  and  $V_{TLP}$  sample window:  $t_1 = 70ns$  to  $t_2 = 90ns$ .

2、 Dynamic resistance calculated from  $I_{PP} = 4A$  to  $I_{PP} = 16A$  using "Best Fit".

Typical Characteristics

Figure 1: Peak Pulse Power vs. Pulse Time

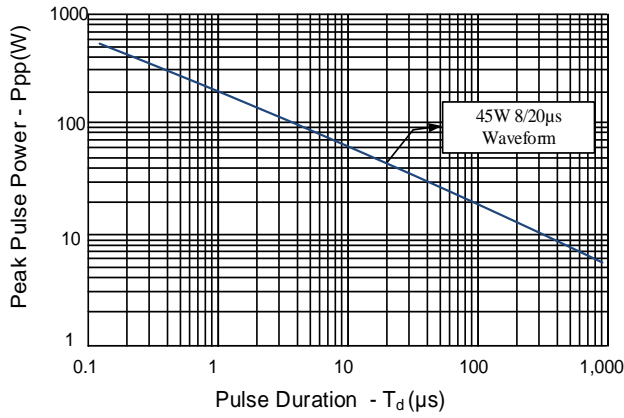

Figure 2: Power Derating Curve

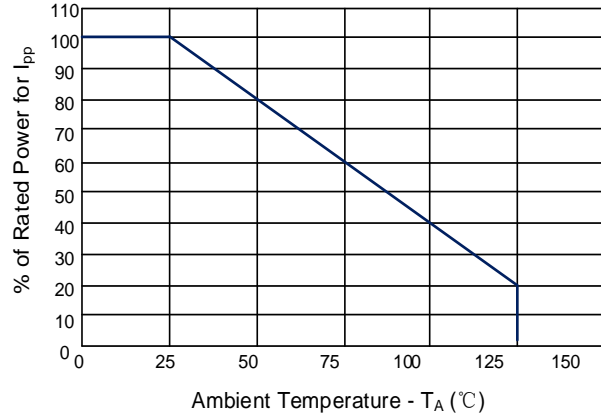

Figure 3: Clamping Voltage vs. Peak Pulse Current

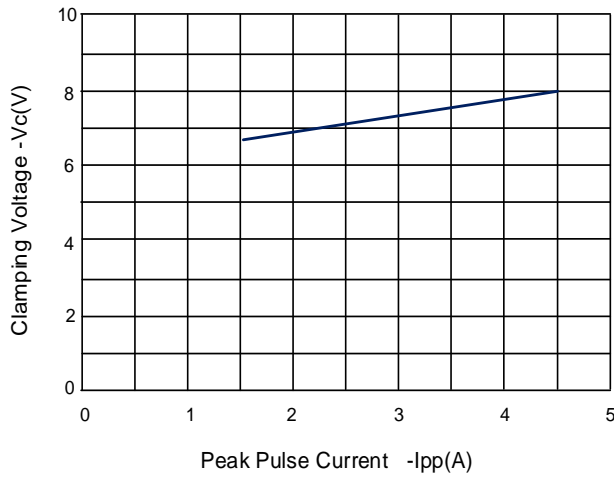

Figure 4: Normalized Junction Capacitance vs. Reverse Voltage

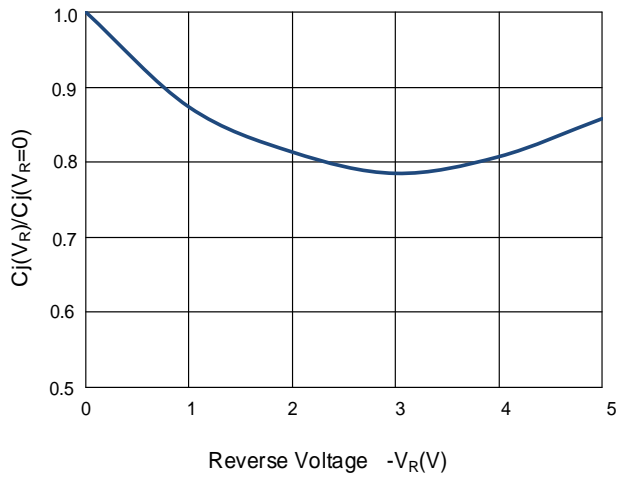

Figure 5: 8/20µs Pulse Waveform

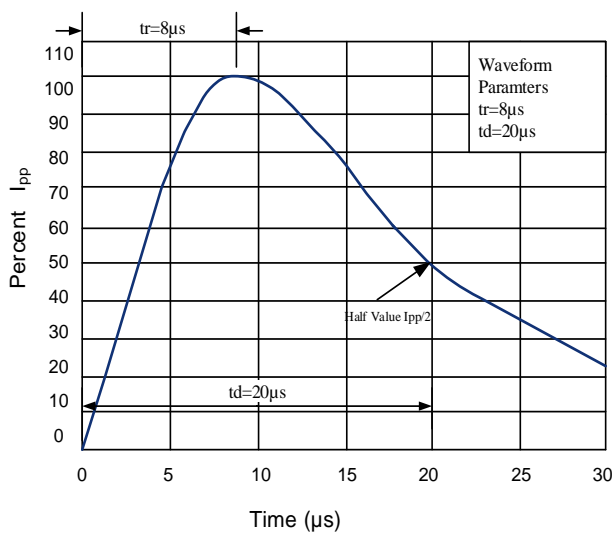
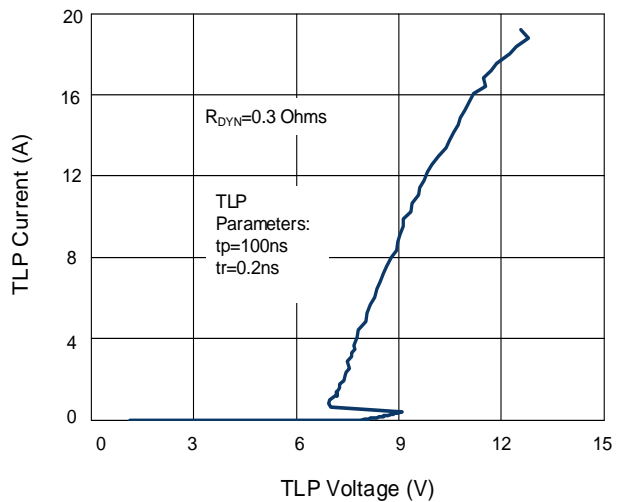
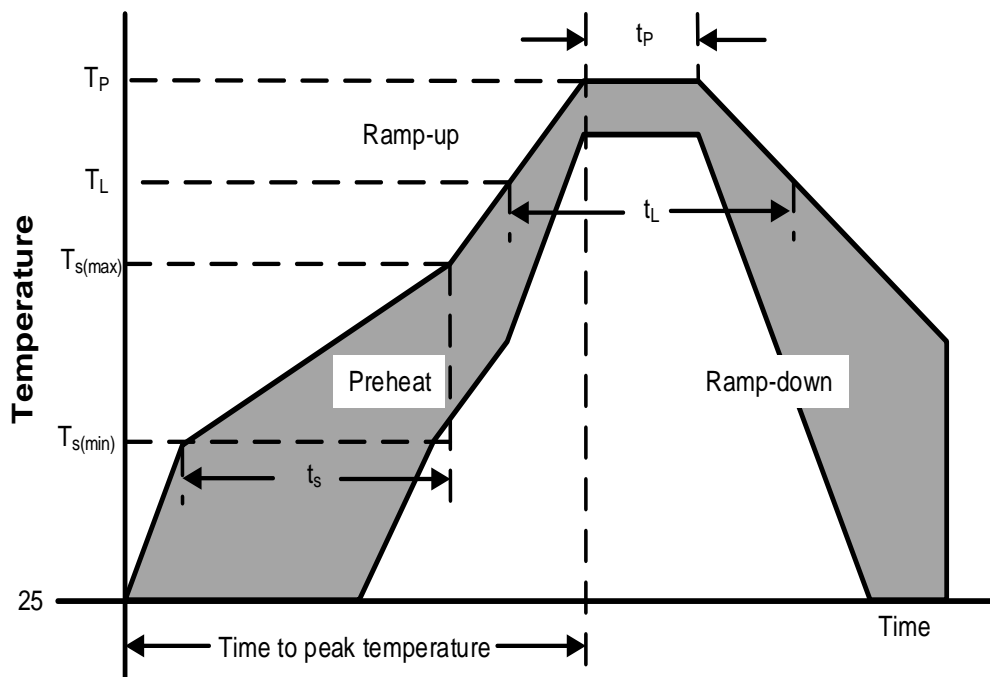

Figure 6: TLP I-V Curve



Soldering Parameters

Reflow Condition		Pb – Free assembly
Pre Heat	Temperature Min ( $T_{s(min)}$ )	150°C
	Temperature Max ( $T_{s(max)}$ )	200°C
	Time (min to max) ( $t_s$ )	60 – 190 secs
Average ramp up rate (Liquidus Temp) ( $T_L$ ) to peak		5°C/second max
$T_{s(max)}$ to $T_L$ — Ramp-up Rate		5°C/second max
Reflow	Temperature ( $T_L$ ) (Liquidus)	217°C
	Temperature ( $t_L$ )	60 – 150 seconds
Peak Temperature ( $T_P$ )		260+0/-5 °C
Time within actual peak Temperature ( $t_p$ )		20 – 40 seconds
Ramp-down Rate		5°C/second max
Time 25°C to peak Temperature ( $T_P$ )		8 minutes Max.
Do not exceed		280°C



Outline Drawing –DFN2510-10L

DFN2.5x1-10L

DIMENSIONS

DIM	INCHES			MILLIMETERS		
	MIN	NOM	MAX	MIN	NOM	MAX
A	0.018	0.020	0.022	0.45	0.50	0.55
A1	0.000	0.001	0.002	0.00	0.02	0.05
A2	0.006			0.15		
b	0.006	0.008	0.010	0.15	0.20	0.25
b1	0.014	0.016	0.018	0.35	0.40	0.45
b2	0.008	0.010	0.018	0.20	0.25	0.45
D	0.096	0.098	0.100	2.45	2.50	2.55
E	0.037	0.039	0.041	0.95	1.00	1.05
e	0.020 BSC			0.50 BSC		
L	0.014	0.016	0.018	0.35	0.40	0.45
L1	0.000	0.003	0.004	0.00	0.075	0.10
L2	0.000	0.002	0.003	0.00	0.05	0.08
h	0.000	0.005	0.006	0.00	0.12	0.15
N	8			8		
N1	2			2		

DIMENSIONS		
DIM	INCHES	MILLIMETERS
C	0.034	0.875
G	0.008	0.20
P	0.020	0.50
P1	0.039	1.00
X	0.010	0.25
X1	0.018	0.45
Y	0.027	0.675
Y1	0.061	1.55

**Notes:**  
Controlling Dimension: Millimeter.

Marking Codes

Part Number	WS5414KC
Marking Code	<div style="border: 1px solid black; display: inline-block; padding: 5px;"> <span style="font-size: 24px; font-weight: bold;">5R3P</span> </div>

Package Information

Qty: 3k/Reel

CONTACT INFORMATION

No.1001, Shiwan (7) Road, Pudong District, Shanghai, P.R.China.201207

Tel: 86-21-68969993 Fax: 86-21-50757680 Email: [market@way-on.com](mailto:market@way-on.com)

WAYON website: <http://www.way-on.com>

For additional information, please contact your local Sales Representative.

**WAYON** ® is registered trademark of Wayon Corporation.

Specifications are subject to change without notice.  
The device characteristics and parameters in this data sheet can and do vary in different applications and actual device performance may vary over time.  
Users should verify actual device performance in their specific applications.

单击下面可查看定价，库存，交付和生命周期等信息

[>>WAY-ON\(维安\)](#)