

## Transient Voltage Suppressor

### Features

- 56 Watts Peak Pulse Power per Line ( $t_p = 8/20\mu s$ )
- Protects one I/O or power line
- Low Clamping Voltage
- Working Voltage: 5 V
- Low Leakage Current

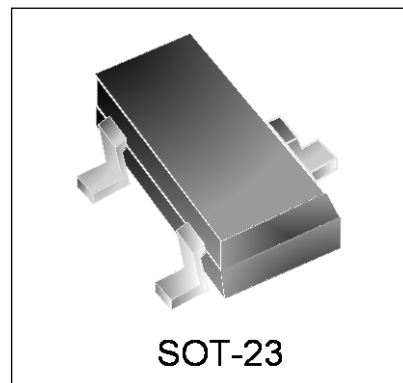

### IEC COMPATIBILITY (EN61000-4)

- IEC 61000-4-2 (ESD)  $\pm 15kV$  (air),  $\pm 15kV$  (contact)
- IEC 61000-4-4 (EFT) 40A (5/50ns)
- IEC 61000-4-5(Surge) 4A (8/20 $\mu s$ )

### Mechanical Characteristics

- SOT-23 package
- Marking : Marking Code
- Packaging : Tape and Reel per EIA 481
- RoHS Compliant

### Applications

- Laptop Computers
- Cellular Phones
- Digital Cameras
- Personal Digital Assistants (PDAs)

### Circuit Diagram

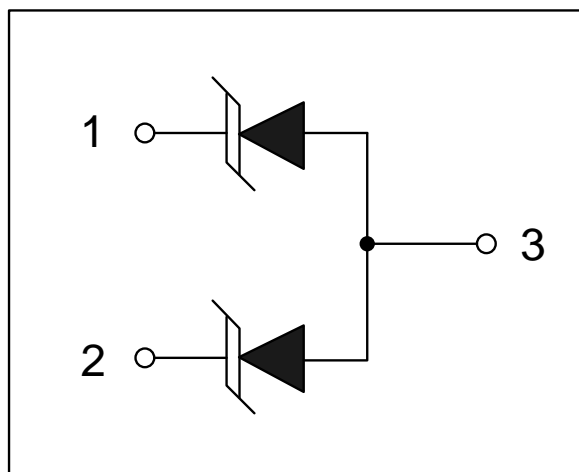

### Schematic & PIN Configuration

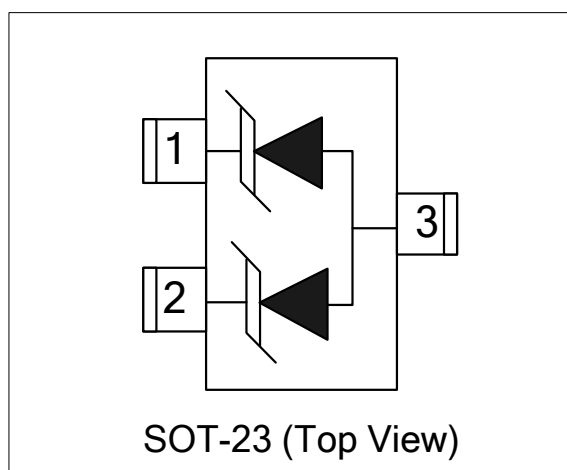

Absolute Maximum Rating			
Rating	Symbol	Value	Units
Peak Pulse Power ( $t_p = 8/20\mu s$ )	$P_{PP}$	56	Watts
Peak Pulse Current ( $t_p = 8/20\mu s$ )	$I_{PP}$	4	A
Operating Temperature	$T_J$	-55 to + 125	$^{\circ}C$
Storage Temperature	$T_{STG}$	-55 to +150	$^{\circ}C$

Electrical Parameters (T=25°C)

Symbol	Parameter
$I_{PP}$	Reverse Peak Pulse Current
$V_C$	Clamping Voltage @ $I_{PP}$
$V_{RWM}$	Reverse Stand-Off Voltage
$I_R$	Reverse Leakage Current @ $V_{RWM}$
$V_{BR}$	Breakdown Voltage @ $I_T$
$I_T$	Test Current
$I_F$	Forward Current
$V_F$	Forward Voltage @ $I_F$

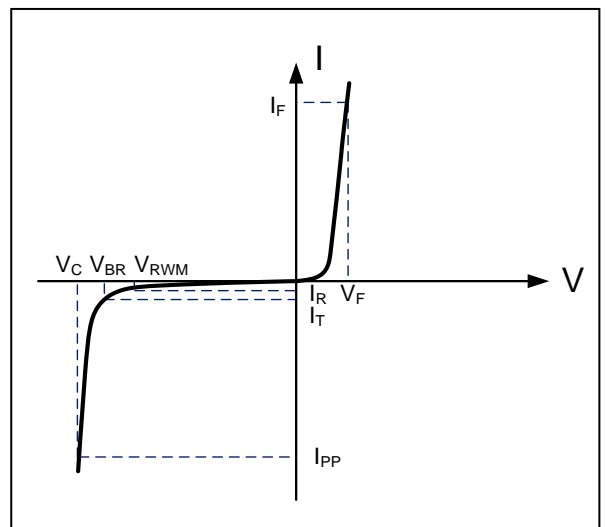

Electrical Characteristics

WE05MLC						
Parameter	Symbol	Conditions	Minimum	Typical	Maximum	Units
Reverse Stand-Off Voltage	$V_{RWM}$				5	V
Reverse Breakdown Voltage	$V_{BR}$	$I_T = 1mA$	6		10	V
Reverse Leakage Current	$I_R$	$V_{RWM} = 5V, T = 25^{\circ}C$			500	nA
Forward Voltage	$V_F$	$I_F = 10mA$	0.5		1	V
Clamping Voltage	$V_C$	$I_{PP} = 4A, t_p = 8/20\mu s$		12	14	V
Dynamic Resistance <sup>1,2</sup>	$R_{DYN}$	$TLP = 0.2/100ns$		0.69		$\Omega$
ESD Clamping Voltage <sup>1</sup>	$V_C$	$I_{PP} = 4A$ $t_p = 0.2/100ns$		11		V
ESD Clamping Voltage <sup>1</sup>	$V_C$	$I_{PP} = 16A$ $t_p = 0.2/100ns$		19.3		V
Junction Capacitance	$C_j$	$VR = 0V, f = 1MHz$ Pin 1 to Pin 2		0.3	0.5	pF
		$VR = 0V, f = 1MHz$ Pin 1 or 2 to Pin 3		0.6	0.8	pF

Note: 1、TLP Setting :  $t_p = 100ns, t_r = 0.2ns, I_{TLP}$  and  $V_{TLP}$  sample window:  $t_1 = 70ns$  to  $t_2 = 90ns$ .

2、Dynamic resistance calculated from  $I_{PP} = 4A$  to  $I_{PP} = 16A$  using "Best Fit"

Typical Characteristics

Figure 1: Peak Pulse Power Vs Pulse Time

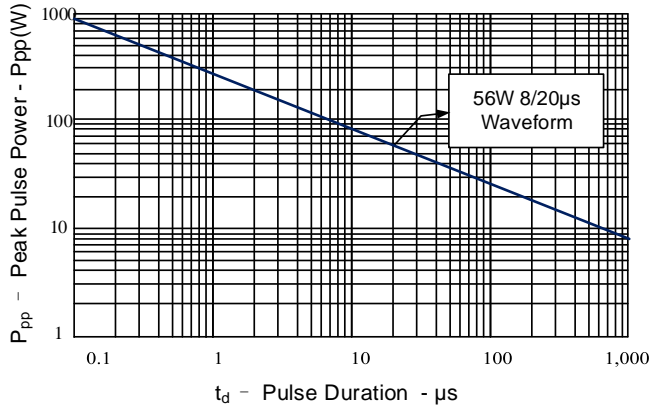

Figure 2: Power Derating Curve

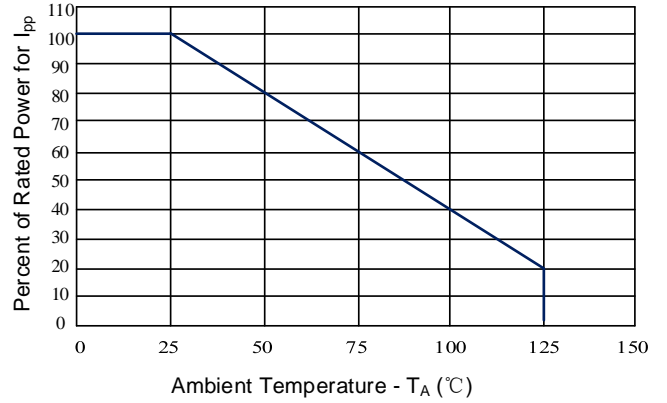

Figure 3: Clamping Voltage vs. Peak Pulse Current

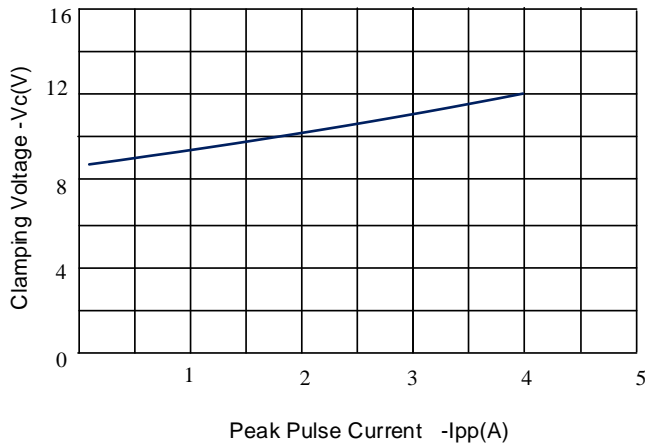

Figure 4: Normalized Junction Capacitance vs. Reverse Voltage

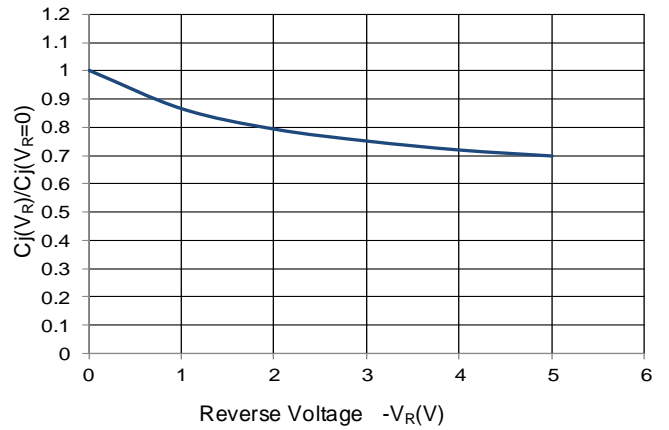

Figure 5: Pulse Waveform

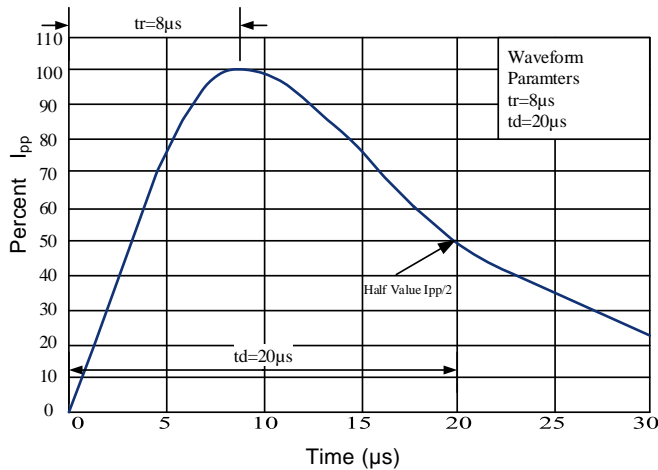
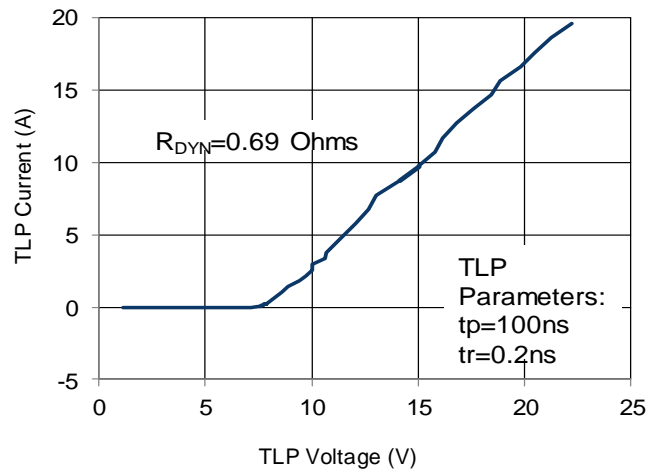
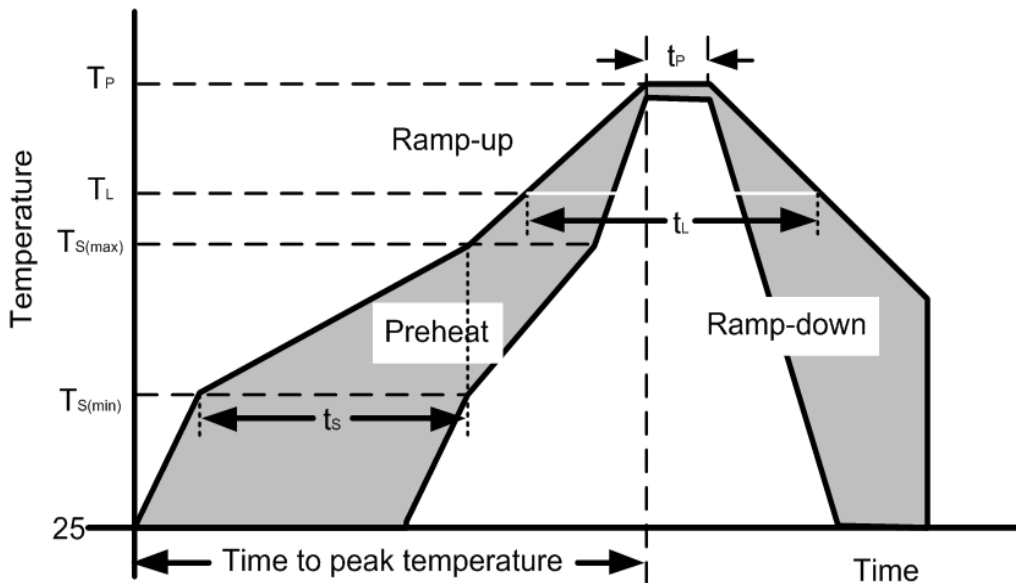

Figure 6: TLP I-V Curve



Soldering Parameters

Reflow Condition		Pb – Free assembly
Pre Heat	Temperature Min ( $T_{S(min)}$ )	150°C
	Temperature Max ( $T_{S(max)}$ )	200°C
	Time (min to max) ( $t_s$ )	60 – 190 secs
Average ramp up rate (Liquidus Temp) ( $T_L$ ) to peak		5°C/second max
$T_{S(max)}$ to $T_L$ —Ramp-up Rate		5°C/second max
Reflow	Temperature ( $T_L$ ) (Liquidus)	217°C
	Temperature ( $t_L$ )	60 – 150 seconds
Peak Temperature ( $T_P$ )		260+0/-5 °C
Time within actual peak Temperature ( $t_p$ )		20 – 40 seconds
Ramp-down Rate		5°C/second max
Time 25°C to peak Temperature ( $T_P$ )		8 minutes Max.
Do not exceed		280°C



Outline Drawing – SOT-23

### PACKAGE OUTLINE

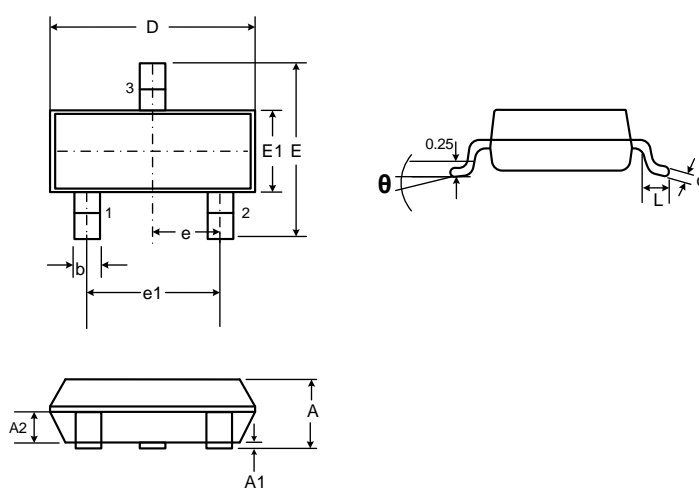

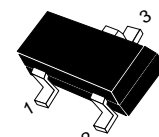

SOT-23

DIMENSIONS				
SYMBOL	MILLIMETERS		INCHES	
	MIN	MAX	MIN	MAX
A	0.90	1.15	0.035	0.045
A1	0.00	0.10	0.000	0.004
A2	0.60	0.70	0.024	0.028
b	0.30	0.50	0.012	0.020
c	0.08	0.15	0.003	0.006
D	2.80	3.00	0.110	0.118
E	2.25	2.55	0.089	0.100
E1	1.20	1.40	0.047	0.055
e	0.95 BSC		0.037 BSC	
e1	1.80	2.00	0.071	0.079
L	0.30	0.50	0.012	0.020
θ	0	8°	0	8°

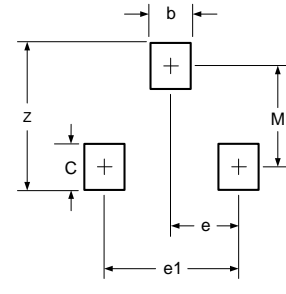

DIMENSIONS		
DIM	INCHES	MILLIMETERS
M	0.0795	2.02
C	0.0315	0.80
Z	0.111	2.82
e	0.037 BSC	0.95 BSC
e1	0.075 BSC	1.9 BSC
b	0.0315	0.80

**Notes:**  
Controlling Dimension: Millimeter.

Marking Codes

Part Number	Marking Code
WE05MLC	5ML

Package Information

Qty: 3k/Reel

CONTACT INFORMATION

No.1001, Shiwan (7) Road, Pudong District, Shanghai, P.R.China.201207  
 Tel: 86-21-68969993 Fax: 86-21-50757680 Email: [market@way-on.com](mailto:market@way-on.com)  
 WAYON website: <http://www.way-on.com>

For additional information, please contact your local Sales Representative.

**WAYON** ® is registered trademark of Wayon Corporation.

Specifications are subject to change without notice.  
 The device characteristics and parameters in this data sheet can and do vary in different applications and actual device performance may vary over time.  
 Users should verify actual device performance in their specific applications.

单击下面可查看定价，库存，交付和生命周期等信息

[>>WAY-ON\(维安\)](#)