



WE05MUC-AT

Transient Voltage Suppressor

Features

- 48 Watts Peak Power per Line ($t_p = 8/20\mu s$)
- Protects two I/O lines
- Low operating voltage: 5V
- Low capacitance($<1.0pF$)
- Solid-state technology
- AEC-Q101 Qualified

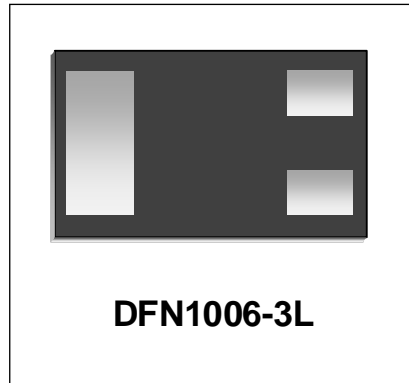

IEC COMPATIBILITY (EN61000-4)

- IEC 61000-4-2 (ESD) $\pm 30kV$ (air), $\pm 30kV$ (contact)
- IEC 61000-4-4 (EFT) 40A (5/50ns)
- IEC 61000-4-5 (Lightning) 4A (8/20 μs)

Mechanical Characteristics

- JEDEC DFN1006-3L package
- Marking : Making Code
- Packaging : Tape and Reel per EIA 481
- RoHS Compliant & HF
- Device meets MSL 1 requirement

Applications

- FireWire & USB
- Sensitive Analog Inputs
- Portable Electronics
- LAN/WAN equipment
- Video Line Protection
- Microcontroller Input Protection

Circuit Diagram

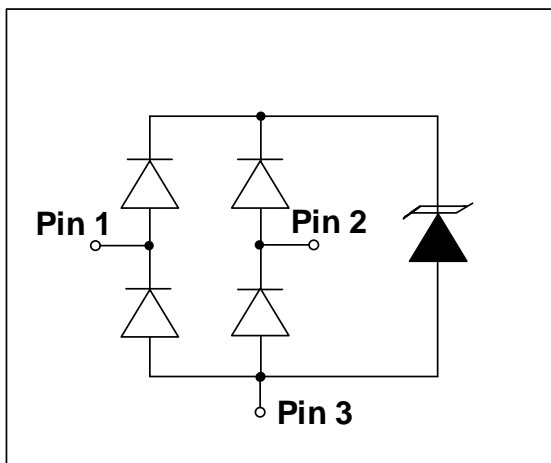

Schematic & PIN Configuration

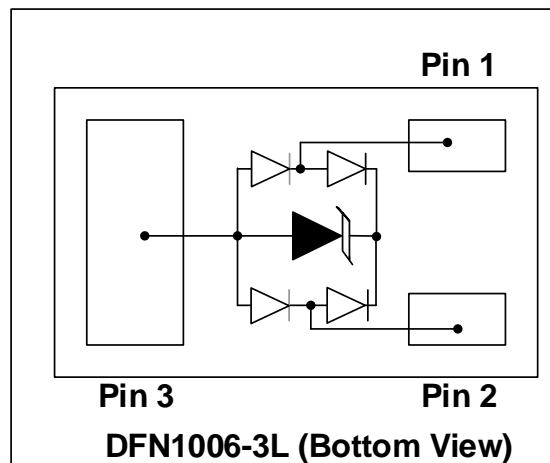

Absolute Maximum Rating			
Rating	Symbol	Value	Units
Peak Pulse Power ($t_p=8/20\mu s$)	P_{PP}	48	Watts
Peak Pulse Current ($t_p=8/20\mu s$)	I_{PP}	4	A
Operating Temperature	T_J	-55 to + 125	$^{\circ}C$
Storage Temperature	T_{STG}	-55 to +150	$^{\circ}C$

Electrical Parameters

Symbol	Parameter
I_{PP}	Reverse Peak Pulse Current
V_C	Clamping Voltage @ I_{PP}
V_{RWM}	Reverse Stand-Off Voltage
I_R	Reverse Leakage Current @ V_{RWM}
V_{BR}	Breakdown Voltage @ I_T
I_T	Test Current
I_F	Forward Current
V_F	Forward Voltage @ I_F

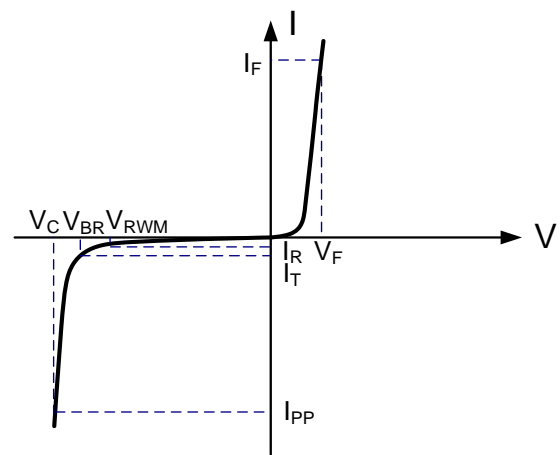

Electrical Characteristics(T=25 $^{\circ}C$ unless otherwise noted)

WE05MUC-AT						
Parameter	Symbol	Conditions	Minimum	Typical	Maximum	Units
Reverse Stand-Off Voltage	V_{RWM}				5.0	V
Breakdown Voltage	V_{BR}	$I_T=1mA$	6.0		9.0	V
Forward Voltage	V_F	$I_F=10mA$	0.6		1.0	V
Reverse Leakage Current	I_R	$V_{RWM}=5V$			500	nA
Clamping Voltage	V_C	$I_{PP}=4A, t_p=8/20\mu s$		10.5	12	V
Dynamic Resistance ^{1,2}	R_{DYN}	TLP=0.2/100ns		0.56		Ω
ESD Clamping Voltage ¹	V_C	$I_{PP} = 4A, t_p = 0.2/100ns$ (TLP)		10.5		V
ESD Clamping Voltage ¹	V_C	$I_{PP} = 16A, t_p = 0.2/100ns$ (TLP)		17.0		V
Junction Capacitance	C_j	$V_R=0V, f=1MHz$ Between I/O pins and Ground		0.5	1.0	pF
		$V_R=0V, f=1MHz$ Between I/O pins		0.2	0.5	pF

Notes : 1、 TLP Setting : $t_p=100ns, t_r=0.2ns, I_{TLP}$ and V_{TLP} sample window: $t_1=70ns$ to $t_2=90ns$.
 2、 Dynamic resistance calculated from $I_{PP}=4A$ to $I_{PP}=16A$ using "Best Fit".

Typical Characteristics

Figure 1: Peak Pulse Power Vs Pulse Time

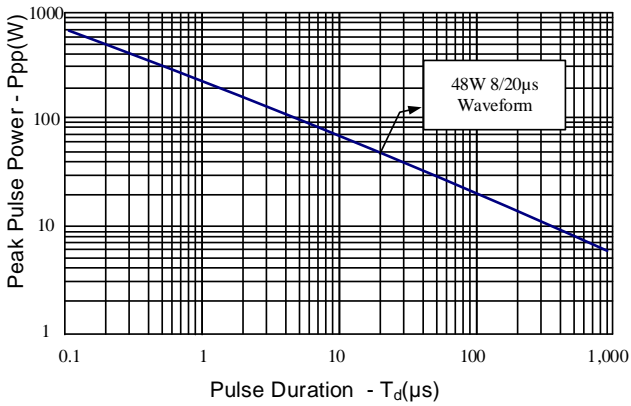

Figure 2: Power Derating Curve

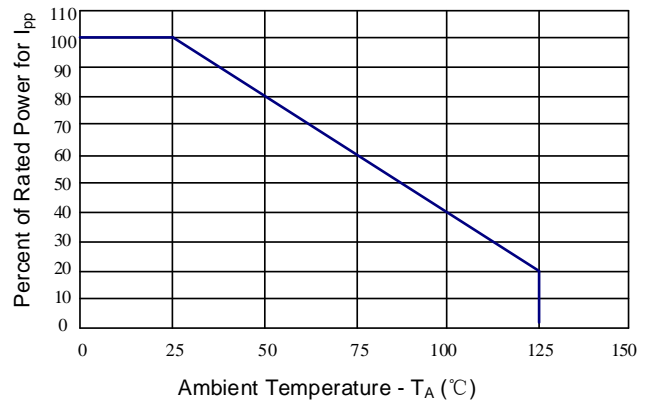

Figure 3: Clamping Voltage vs. Peak Pulse Current

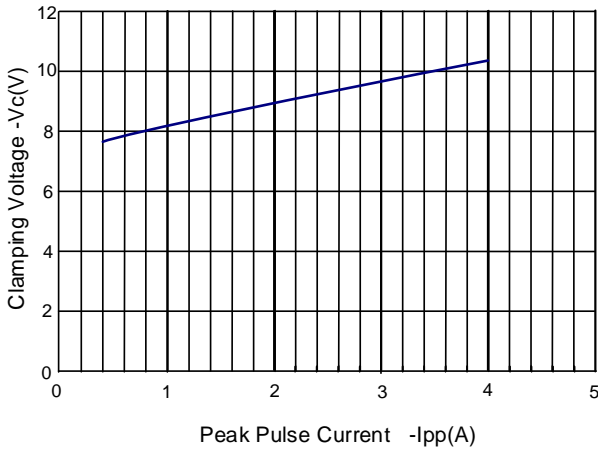

Figure 4: Capacitance vs. Reverse Voltage

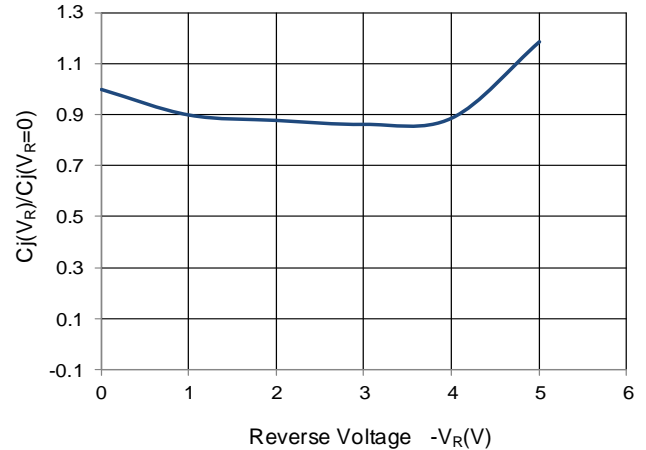

Figure 5: 8/20μs Pulse Waveform

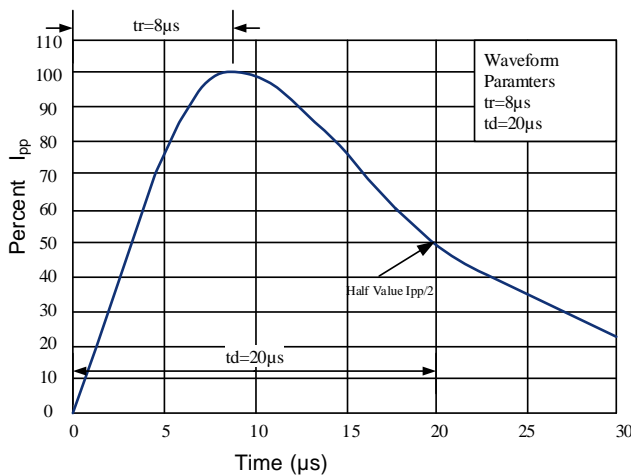
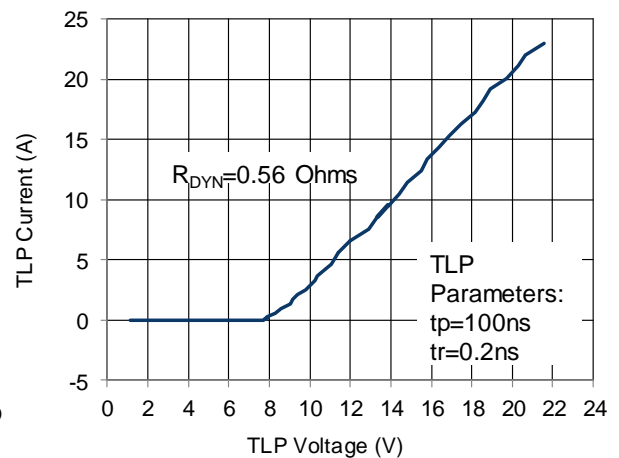
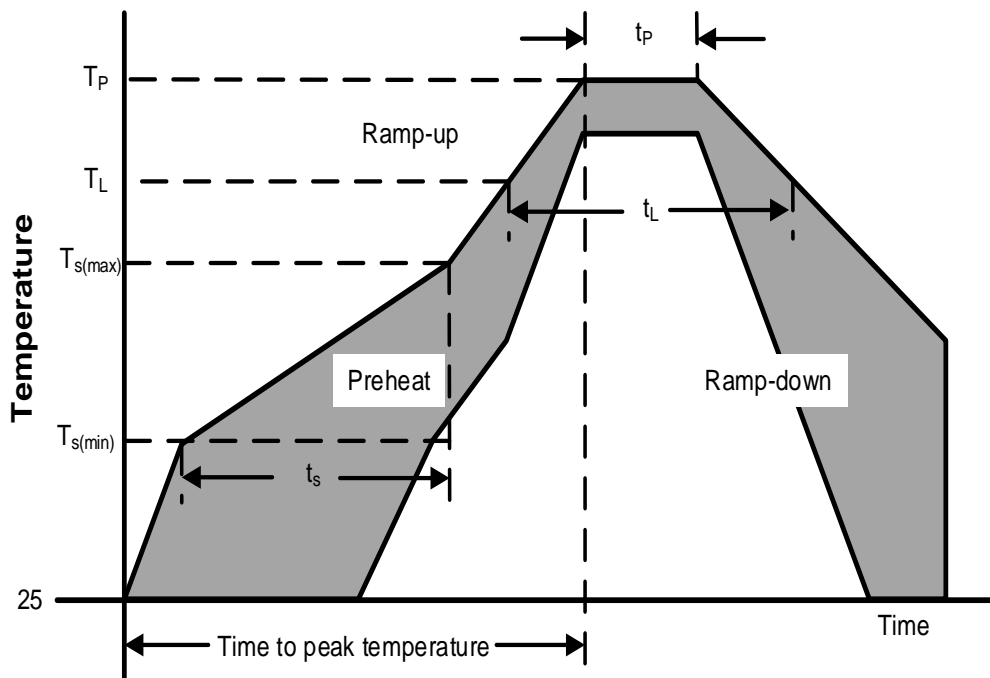

Figure 6: TLP I-V Curve



Soldering Parameters

Reflow Condition		Pb – Free assembly
Pre Heat	Temperature Min ($T_{s(min)}$)	150°C
	Temperature Max ($T_{s(max)}$)	200°C
	Time (min to max) (t_s)	60 – 190 secs
Average ramp up rate (Liquidus Temp) (T_L) to peak		5°C/second max
$T_{s(max)}$ to T_L —Ramp-up Rate		5°C/second max
Reflow	Temperature (T_L) (Liquidus)	217°C
	Temperature (t_L)	60 – 150 seconds
Peak Temperature (T_P)		260+0/-5 °C
Time within actual peak Temperature (t_p)		20 – 40 seconds
Ramp-down Rate		5°C/second max
Time 25°C to peak Temperature (T_P)		8 minutes Max.
Do not exceed		280°C



Tape And Reel Information

Reel Dimensions

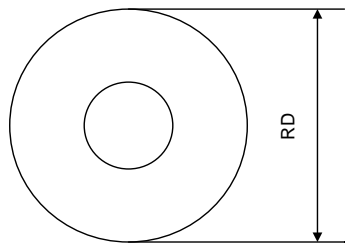

Tape Dimensions

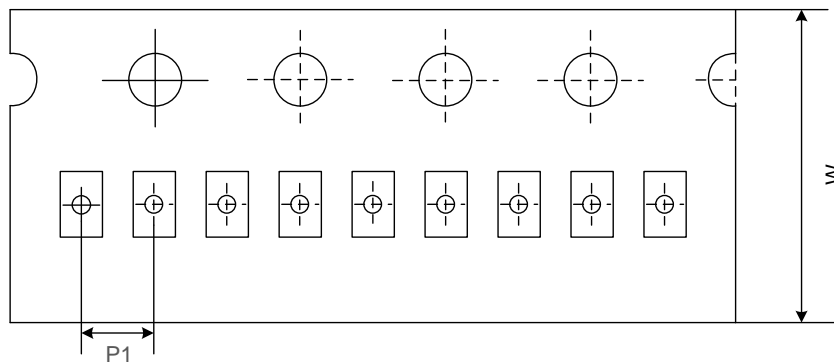

Quadrant Assignments For PIN1 Orientation In Tape

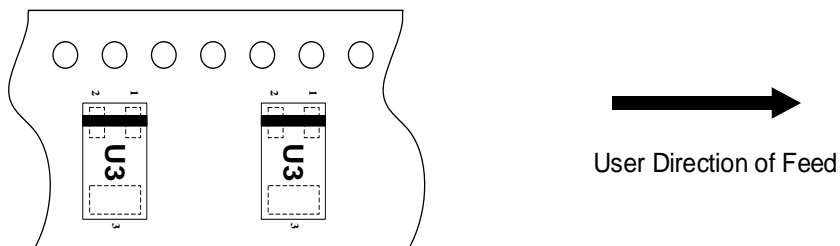

RD	Reel Dimensions	7 inch
W	Overall width of the carrier tape	8 mm
P1	Pitch between successive cavity centers	2mm

Outline Drawing – DFN1006-3L

PACKAGE OUTLINE

TOP VIEW

BOTTOM VIEW

DFN1006-3L

SYMBOL	MILLIMETERS		
	MIN	NOM	MAX
A	0.45	0.50	0.60
A1	0	0.02	0.05
b	0.45	0.50	0.55
b1	0.10	0.15	0.20
C	0.12	0.15	0.18
D	0.95	1.00	1.05
e	0.65BSC		
E	0.55	0.60	0.65
E1	0.15	0.20	0.25
L	0.20	0.25	0.30
L1	0.05REF		

Land Pattern

Marking Codes

Part Number	Marking Code
WE05MUC-AT	

Package Information

Qty: 10k/Reel

CONTACT INFORMATION

No.1001, Shiwan (7) Road, Pudong District, Shanghai, P.R.China.201207

Tel: 86-21-68969993 Fax: 86-21-50757680 Email: market@way-on.com

WAYON website: <http://www.way-on.com>

For additional information, please contact your local Sales Representative.

WAYON ® is registered trademark of Wayon Corporation.

Specifications are subject to change without notice.
The device characteristics and parameters in this data sheet can and do vary in different applications and actual device performance may vary over time.
Users should verify actual device performance in their specific applications.

单击下面可查看定价，库存，交付和生命周期等信息

[>>WAY-ON\(维安\)](#)