

## Ultra-low Capacitance Thyristor Surge Protector

### Features

- Integrated Bi-directional thyristor for Surge Protection
- Ultra-low capacitance
- High surge capability
- Low leakage current
- Short-circuit failure mode

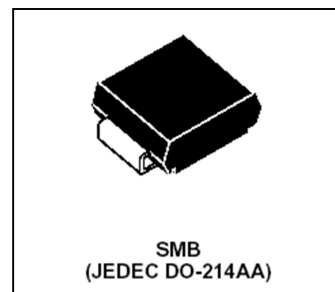

### Main Application

- Data lines and security systems.
- CATV line amplifiers and power inserters.
- Sprinkler systems.

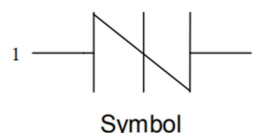

### Absolute Maximum Ratings ( $T_A = 25^\circ\text{C}$ )

Parameter	Symbol	Value	Unit
Non-repetitive peak impulse current 10/1000 $\mu\text{s}$ (Telcordia GR-1089-CORE)	$I_{PPSM}$	100	A
Non-repetitive peak impulse Voltage 10/700 $\mu\text{s}$ (ITU-T K.20, K.21 & K.44, K.45)	$V_{PPSM}$	6000	V

### Electrical Parameters ( $T_A = 25^\circ\text{C}$ )

Part Number	$V_{DRM}$	$I_{DRM}$	$V_{BO}$	$I_{BO}$	$V_T$	$I_T$	$I_H$	$C_O$
	Max.	Max.	Typ.	Max.	Max.	Max.	Min.	Typ.
	V	$\mu\text{A}$	V	mA	V	A	mA	pF
WES1006SUC	6	5	25	800	4	2.2	18	15

**$V_{DRM}$ :** Stand-off voltage, is measured at  $I_{DRM}$ .

**$I_{DRM}$ :** Leakage current at  $V_{DRM}$ .

**$V_{BO}$ :** Breakover voltage, is measured at 100V/ $\mu\text{s}$ .

**$I_{BO}$ :** Breakover current.

**$V_T$ :** On-state voltage.

**$I_T$ :** On-state current.

**$C_O$ :** Off-state capacitance.

**$I_H$ :** Holding current.

**$V_{BR}$ :** Breakdown voltage, is measured at 1mA.

**$I_{PP}$ :** Peak pulse current, is a repetitive surge rating and is guaranteed for the life of the product.

**$V_{ppsm}$ :** Peak pulse voltage, is a repetitive surge rating and is guaranteed for the life of the product.

### General Notes:

- All measurements are made at an ambient temperature of 25 °C. IPP applies to -40 °C through +85 °C temperature range.
- Listed WES devices are bi-directional. All electrical parameters and surge ratings apply to forward and reverse polarities.
- Special voltage (VBO and VDRM) and holding current (IH) requirements are available up on request.
- Off-state capacitance is measured at 1 MHz with a 2 V bias.

Thermal Resistances

Symbol	Parameter	Value	Unit
Ts	Storage temperature range	-55 to +150	°C
Tj	Maximum junction temperature	-40 to +125	°C

Electrical Characteristics Curves

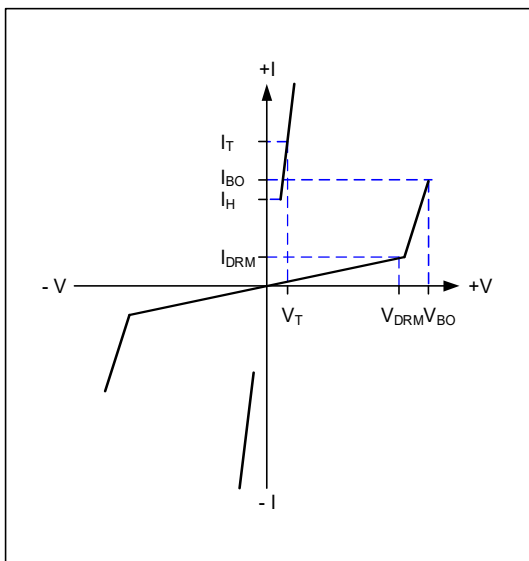

V - I Characteristics

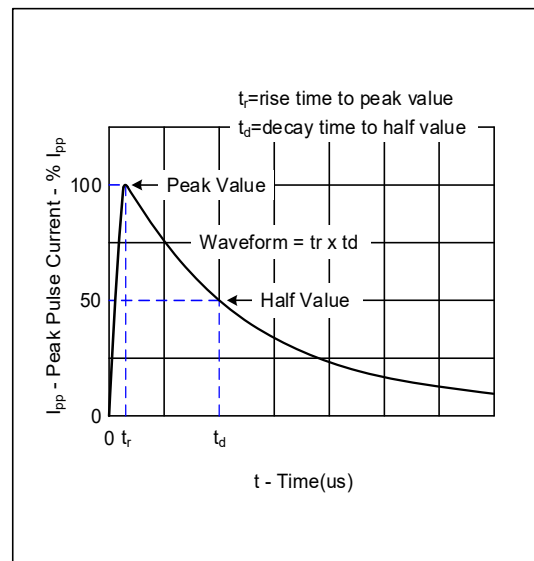

$t_r$  X  $t_d$  Pulse Waveform

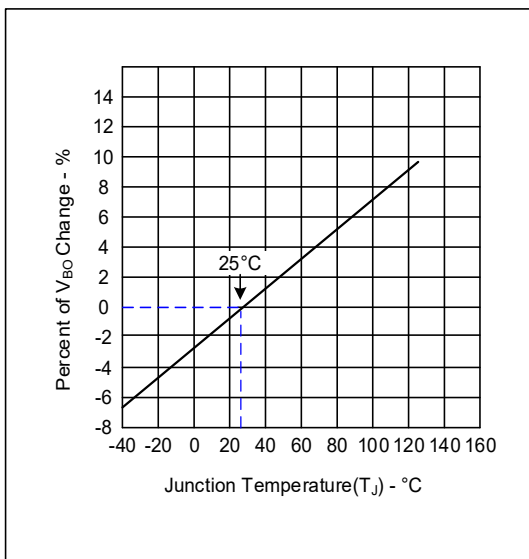

Normalized  $V_{BO}$  Change versus Junction Temperature

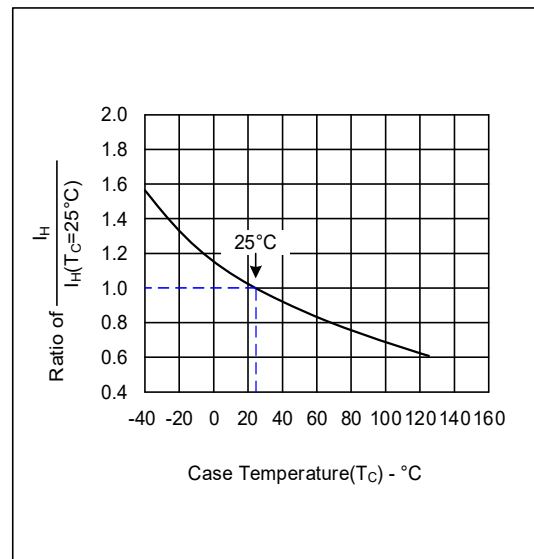

Normalized DC Holding Current versus Case Temperature

Soldering Parameters

Reflow Condition		
Pre Heat	Temperature Min ( $T_{s(min)}$ )	150°C
	Temperature Max ( $T_{s(max)}$ )	200°C
	Time (min to max) ( $t_s$ )	60-190 s
Average ramp up rate (Liquidus Temp) ( $T_L$ ) to peak		3°C/s max
Ts(max) to TL - Ramp-up Rate		3°C/s max
Reflow	Temperature ( $T_L$ ) (Liquidus)	217°C
	Temperature ( $t_L$ )	60-150 s
Peak Temperature ( $T_P$ )		260 <sup>+0/-5</sup> °C
Time within actual peak Temperature ( $t_p$ )		20-40 s
Ramp-down Rate		5°C/s max
Time 25°C to peak Temperature ( $T_P$ )		8 minutes Max.
Do not exceed		260°C

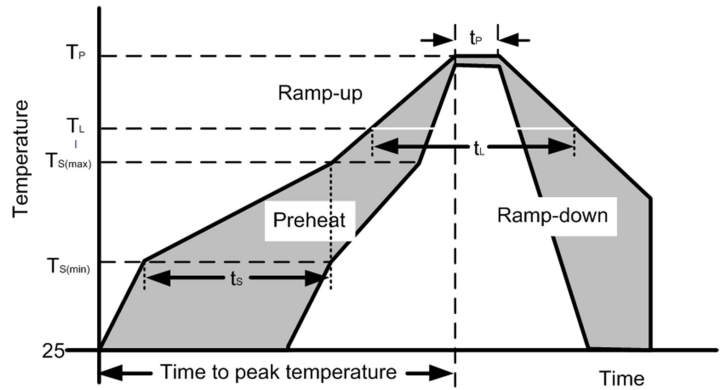

Product Dimensions

Ref. (mm)	Min.	Max.
A	2.130	2.600
A1	-	0.300
B	1.900	2.200
E	4.100	4.750
E1	5.210	5.590
D	3.300	3.940
L	0.760	1.520

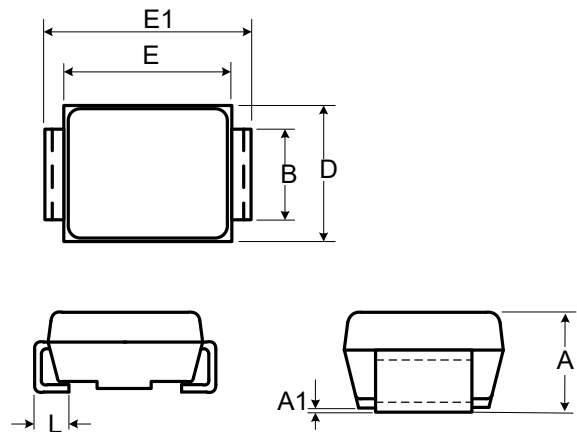

Recommended Solder Pad Layout

DIM(mm)	MILLIMETERS
A	2.74
B	2.26
C	2.16

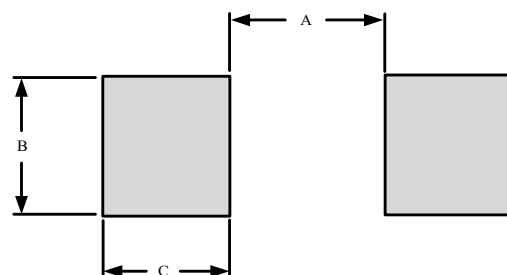

## Part Numbering System And Marking

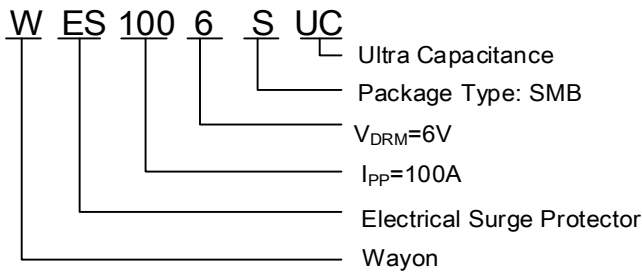

### Marking:

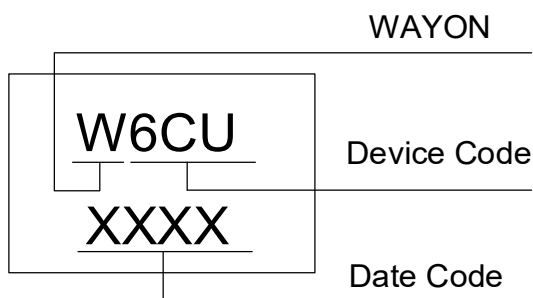

### Package Information

Package Type	Description	Quantity (pcs)
SMB(DO-214AA)	Tape & Reel Pack	2500

### Contact Information

No.1001, Shiwan(7) Road, Pudong District, Shanghai, P.R.China.201207

Tel: 021-68969993 Fax: 86-21-50757680 Email: market@way-on.com

WAYON website: <http://www.way-on.com>

For additional information, please contact your local Sales Representative.

**WAYON**® is registered trademarks of Wayon Corporation.

*Specifications are subject to change without notice.*

*The device characteristics and parameters in this data sheet can and do vary in different applications and actual device performance may vary over time. Users should verify actual device performance in their specific applications.*

单击下面可查看定价，库存，交付和生命周期等信息

[>>WAY-ON\(维安\)](#)