

## PNP Silicon Transistor

### Features

- Ideally Suited for Automatic Insertion
- For Switching and AF Amplifier Applications

### Mechanical Characteristics

- SOT-23 Package
- Marking : Making Code
- RoHS Compliant

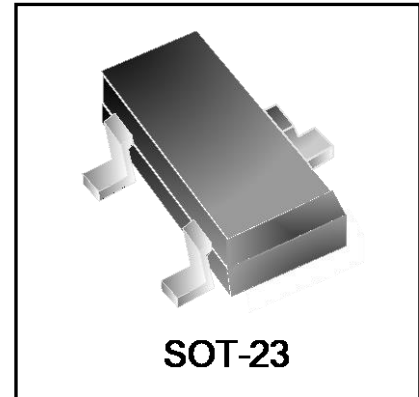

### Schematic & PIN Configuration

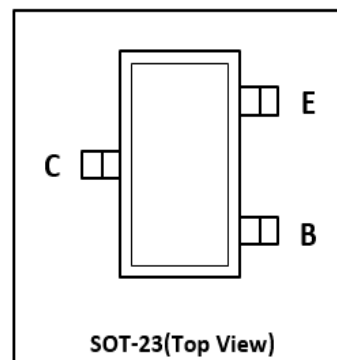
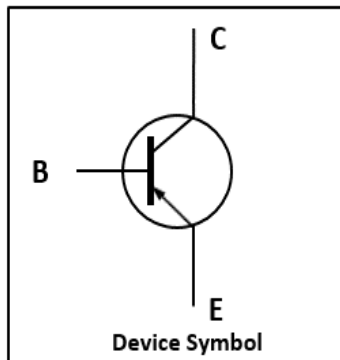

### Absolute Maximum Rating

Parameter	Symbol	Value	Unit
Collector Base Voltage	$V_{CBO}$	-50	V
Collector Emitter Voltage	$V_{CEO}$	-45	V
Emitter Base Voltage	$V_{EBO}$	-5	V
Collector Current	$I_C$	-0.1	A
Collector Power Dissipation	$P_C$	200	mW
Junction Temperature	$T_j$	150	°C
Storage Temperature	$T_{stg}$	-55 ~ 150	°C
Thermal Resistance from Junction to Ambient	$R_{\theta JA}$	625	°C/W

Electrical Characteristics (T<sub>amb</sub>=25°C unless otherwise noted)

Parameter	Symbol	Test Conditions	Min.	Typ.	Max.	Unit
Collector-Base Breakdown Voltage	V <sub>(BR)CBO</sub>	I <sub>C</sub> = -10μA, I <sub>E</sub> = 0	-50	-	-	V
Collector-Emitter Breakdown Voltage	V <sub>(BR)CEO</sub>	I <sub>C</sub> = -10mA, I <sub>B</sub> = 0	-45	-	-	V
Emitter-Base Breakdown Voltage	V <sub>(BR)EBO</sub>	I <sub>E</sub> = -1μA, I <sub>C</sub> = 0	-5	-	-	V
Collector Cut-off Current	I <sub>CBO</sub>	V <sub>CB</sub> = -45V, I <sub>E</sub> = 0	-	-	-100	nA
Collector Cut-off Current	I <sub>CEO</sub>	V <sub>CE</sub> = -40V, I <sub>B</sub> = 0	-	-	-100	nA
Emitter Cut-off Current	I <sub>EBO</sub>	V <sub>EB</sub> = -5V, I <sub>C</sub> = 0	-	-	-100	nA
DC Current Gain	h <sub>FE(1)</sub>	V <sub>CE</sub> = -5V, I <sub>C</sub> = -2mA	220	-	475	-
	h <sub>FE(2)</sub>	V <sub>CE</sub> = -5V, I <sub>C</sub> = -1mA	125	-	-	-
Collector-Emitter Saturation Voltage	V <sub>CE(sat)</sub>	I <sub>C</sub> = -100mA, I <sub>B</sub> = -5mA	-	-	-0.5	V
Base-Emitter Saturation Voltage	V <sub>BE(sat)</sub>	I <sub>C</sub> = -100mA, I <sub>B</sub> = -5mA	-	-	-1.1	V
Transition Frequency	f <sub>T</sub>	V <sub>CE</sub> = -5V, I <sub>C</sub> = -10mA, f = 100MHz	100	-	-	MHz
Collector Output Capacitance	C <sub>ob</sub>	V <sub>CB</sub> = -10V, f = 1MHz	-	-	4.5	pF

Typical Characteristics

Figure 1. Static Characteristics

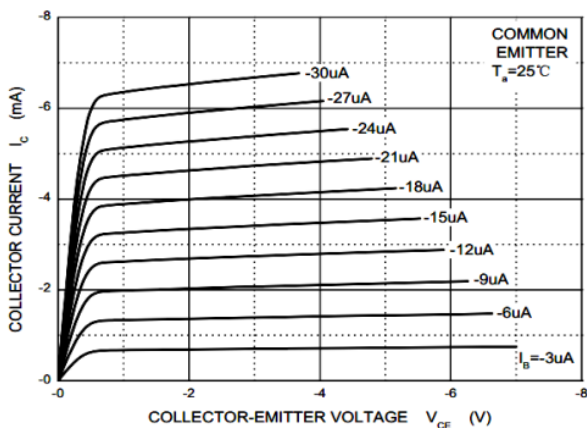

Figure 2. h<sub>FE</sub> vs. I<sub>C</sub>

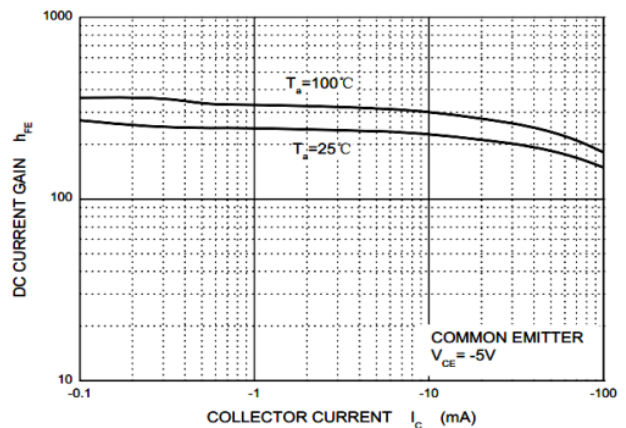

Figure 3.  $V_{CE(sat)}$  vs.  $I_c$

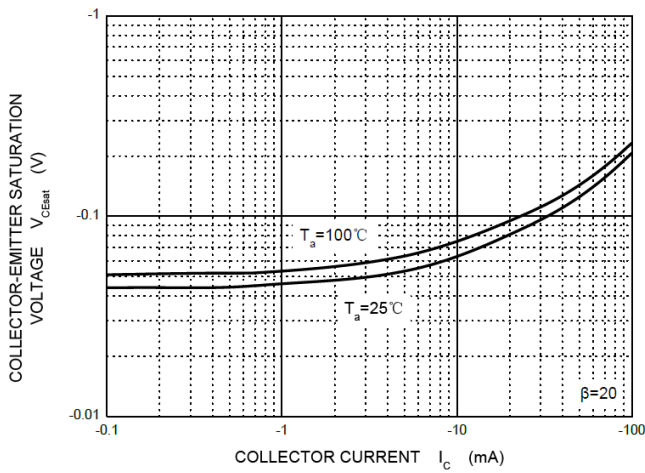

Figure 4.  $V_{BE(sat)}$  vs.  $I_c$

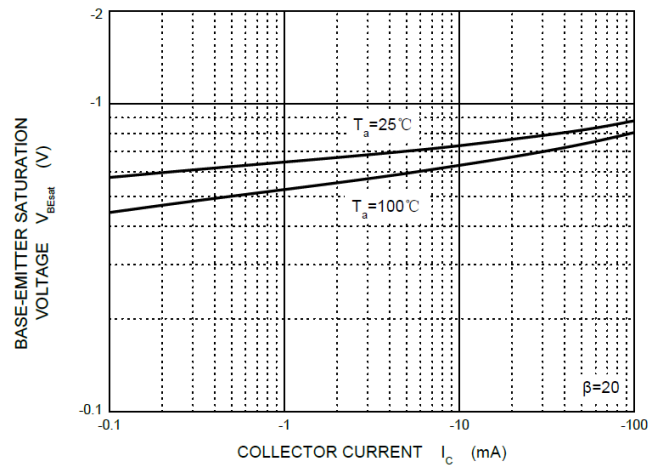

Figure 5.  $I_c$  vs.  $V_{BE}$

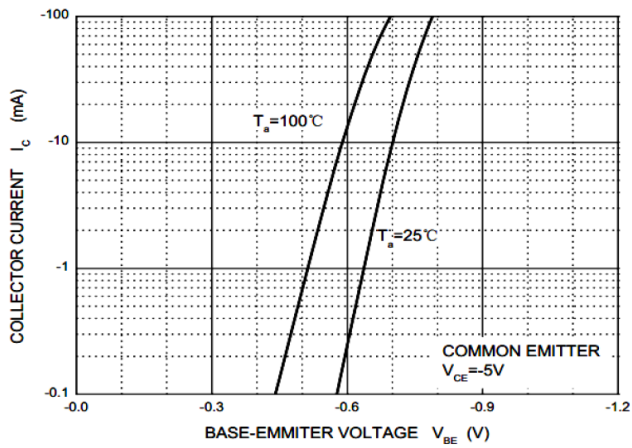

Figure 6.  $f_T$  vs.  $I_c$

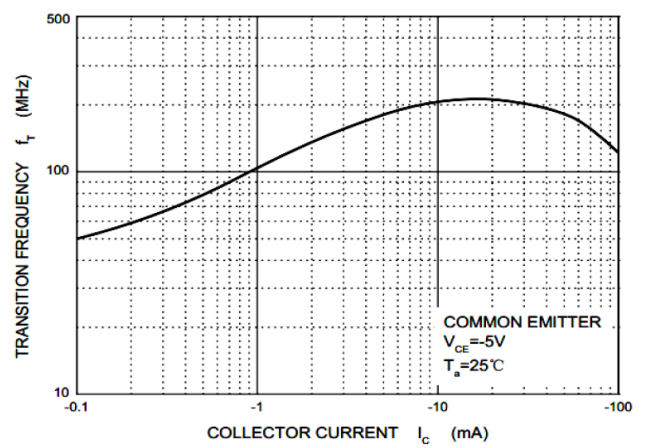

Figure 7.  $C_{ob} / C_{ib}$  vs.  $V_{CB} / V_{EB}$

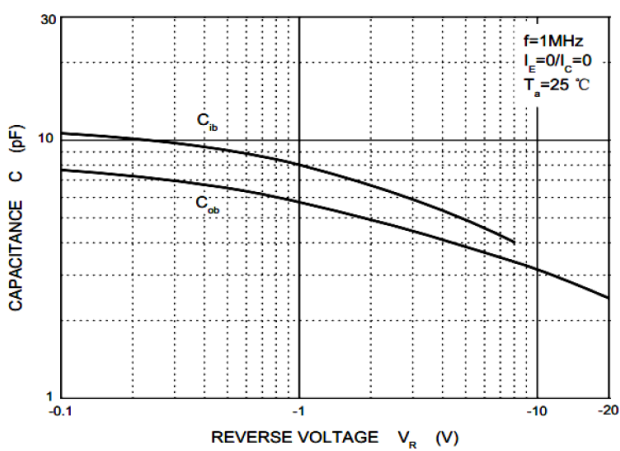
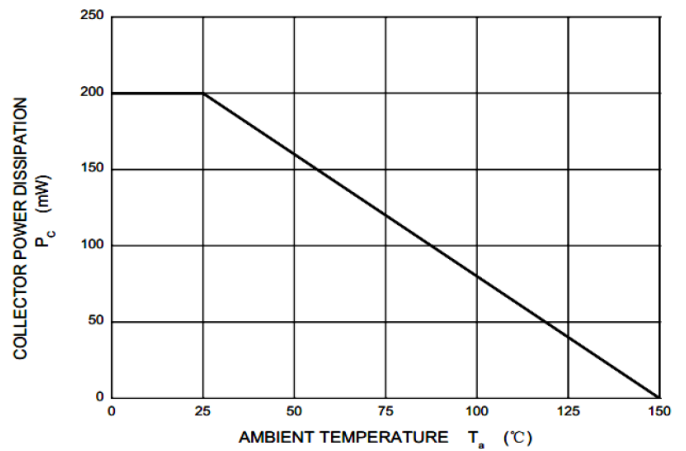

Figure 8.  $P_c$  vs.  $T_a$



Outline Drawing – SOT-23

### PACKAGE OUTLINE

**SOT-23**

DIMENSIONS				
SYMBOL	MILLIMETER		INCHES	
	MIN	MAX	MIN	MAX
A	0.90	1.15	0.035	0.045
A1	0.00	0.10	0.000	0.004
b	0.30	0.50	0.012	0.020
c	0.08	0.15	0.003	0.006
D	2.80	3.00	0.110	0.118
E	2.25	2.55	0.089	0.100
E1	1.20	1.40	0.047	0.055
e	0.95 BSC		0.0374 BSC	
e1	1.80	2.00	0.071	0.079
L	0.45	0.65	0.018	0.026
θ	0	8°	0	8°

DIMENSIONS		
DIM	INCHES	MILLIMETERS
M	0.080	2.02
C	0.032	0.80
Z	0.111	2.82
e	0.037 BSC	0.95 BSC
e1	0.075 BSC	1.90 BSC
b	0.032	0.80

**Notes**

1. Dimensioning and tolerances per ANSI Y14.5M, 1985.
2. Controlling Dimension: Inches
3. Pin 3 is the cathode (Unidirectional Only).
4. Dimensions are exclusive of mold flash and metal burrs.

Marking Codes

Part Number	WT857B
Marking Code	

Package Information

Qty: 3k/Reel

CONTACT INFORMATION

**CYG WAYON CIRCUIT PROTECTION CO., LTD.**

No.1001, Shiwan (7) Road, Pudong District, Shanghai, P.R.China.201207

Tel: 86-21-68969993 Fax: 86-21-50757680 Email: [market@way-on.com](mailto:market@way-on.com)

WAYON website: <http://www.way-on.com>

For additional information, please contact your local Sales Representative.

**WAYON**® is registered trademark of Wayon Corporation.

Specifications are subject to change without notice.  
The device characteristics and parameters in this data sheet can and do vary in different applications and actual device performance may vary over time.  
Users should verify actual device performance in their specific applications.

单击下面可查看定价，库存，交付和生命周期等信息

[>>WAY-ON\(维安\)](#)