

Transient Voltage Suppressor

Features

- 200 watts peak pulse power ($t_p = 8/20\mu s$)
- Low Clamping Voltage
- Working Voltages: 12V
- Low Leakage Current

IEC COMPATIBILITY (EN61000-4)

- IEC 61000-4-2 (ESD) $\pm 30kV$ (air), $\pm 30kV$ (contact)
- IEC 61000-4-4 (EFT) 40A (5/50ns)
- IEC 61000-4-5 (Lightning) 8A (8/20 μs)

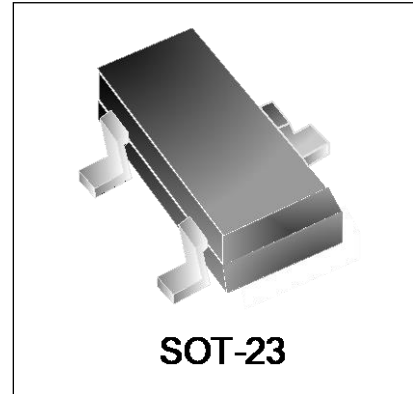

Mechanical Characteristics

- JEDEC SOT-23 package
- Marking: Marking Code
- Packaging: Tape and Reel per EIA 481
- RoHS Compliant & HF
- Device meets MSL3 requirement

Applications

- RS-232, RS-422 & RS-485
- Cellular Handsets and Accessories
- Control & Monitoring Systems
- Portable Electronics
- Set-Top Box
- Servers, Notebook, and Desktop PC
- Wireless Bus Protection

Circuit Diagram

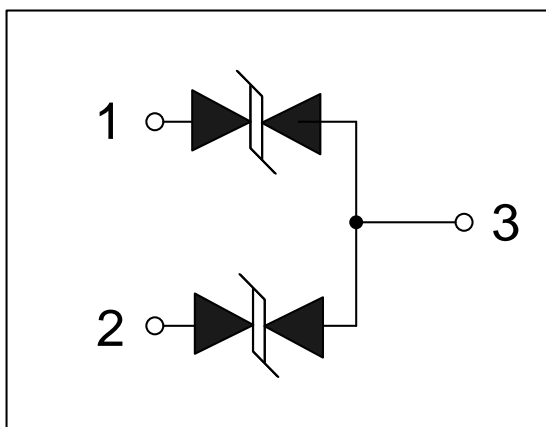

Schematic & PIN Configuration

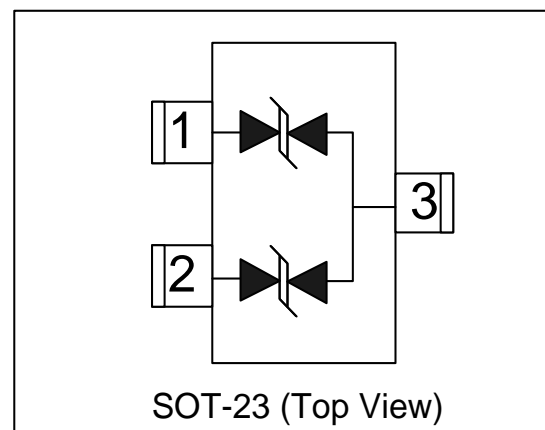

| Absolute Maximum Rating | | | |
|--|-----------|--------------|-------------|
| Rating | Symbol | Value | Units |
| Peak Pulse Power ($t_p=8/20\mu s$) | P_{PP} | 200 | Watts |
| Peak Pulse Current ($t_p=8/20\mu s$) | I_{PP} | 8 | A |
| Operating Temperature | T_J | -55 to + 125 | $^{\circ}C$ |
| Storage Temperature | T_{STG} | -55 to +150 | $^{\circ}C$ |

Electrical Parameters

| Symbol | Parameter |
|-----------|-------------------------------------|
| I_{PP} | Reverse Peak Pulse Current |
| V_C | Clamping Voltage @ I_{PP} |
| V_{RWM} | Working Peak Reverse Voltage |
| I_R | Reverse Leakage Current @ V_{RWM} |
| V_{BR} | Breakdown Voltage @ I_T |
| I_T | Test Current |

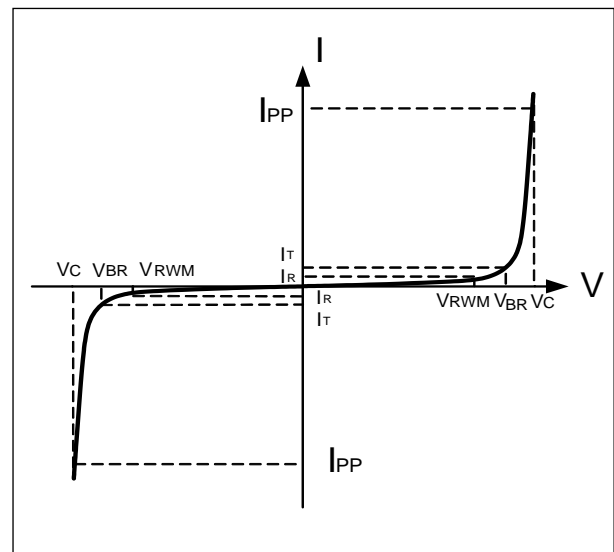

Electrical Characteristics(T=25°C unless otherwise noted)

| WS1219PT | | | | | | |
|-----------------------------------|-----------|---|---------|---------|---------|----------|
| Parameter | Symbol | Conditions | Minimum | Typical | Maximum | Units |
| Reverse Stand-Off Voltage | V_{RWM} | | | | 12 | V |
| Reverse Breakdown Voltage | V_{BR} | $I_T=1mA$ | 13.3 | | | V |
| Reverse Leakage Current | I_R | $V_{RWM}=12V$ | | | 500 | nA |
| Clamping Voltage | V_C | $I_{PP}=1A, t_p=8/20\mu s$ | | | 18 | V |
| Maximum Clamping Voltage | V_C | $I_{PP}=8A, t_p=8/20\mu s$ | | 23 | 25 | V |
| Dynamic Resistance ^{1,2} | R_{DYN} | TLP=0.2/100ns | | 0..39 | | Ω |
| ESD Clamping Voltage ¹ | V_C | $I_{PP} = 4A,$ $t_p = 0.2/100ns$ (TLP) | | 17.3 | | V |
| ESD Clamping Voltage ¹ | V_C | $I_{PP} = 16A,$ $t_p = 0.2/100ns$ (TLP) | | 22.1 | | V |
| Junction Capacitance | C_j | Pin 1 to 3 and Pin 2 to 3 $V_R = 0V, f = 1MHz$ | | 23 | 40 | pF |

Notes : 1. TLP Setting : $t_p=100ns, t_r=0.2ns, I_{TLP}$ and V_{TLP} sample window: $t_1=70ns$ to $t_2=90ns$.
 2. Dynamic resistance calculated from $I_{PP}=4A$ to $I_{PP}=16A$ using "Best Fit".

Typical Characteristics

Figure 1: Peak Pulse Power vs. Pulse Time

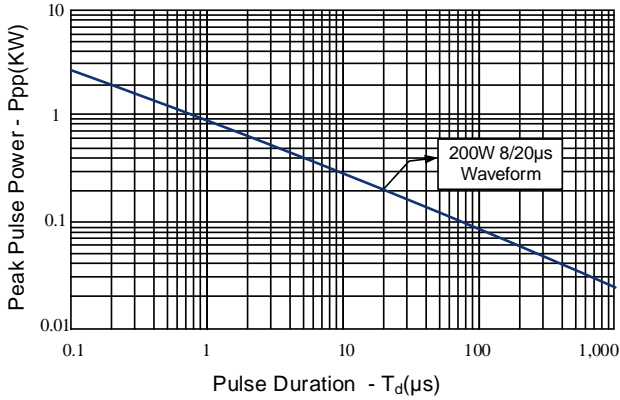

Figure 2: Power Derating Curve

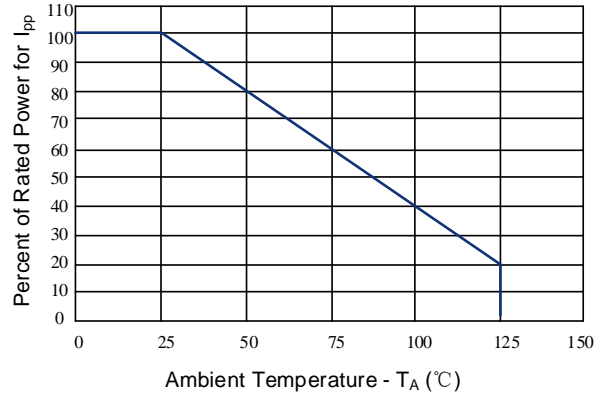

Figure 3: Clamping Voltage vs. Peak Pulse Current

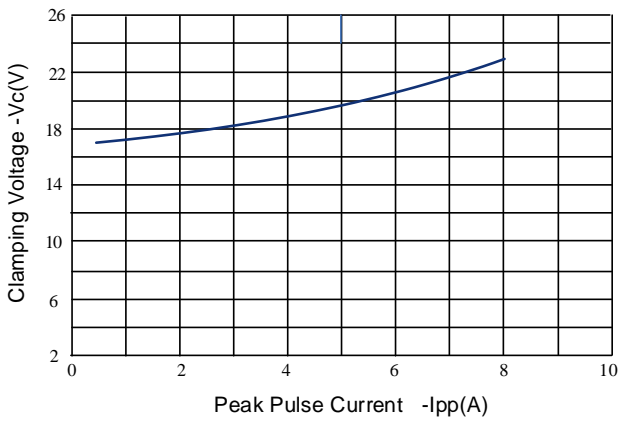

Figure 4: Normalized Junction Capacitance vs. Reverse Voltage

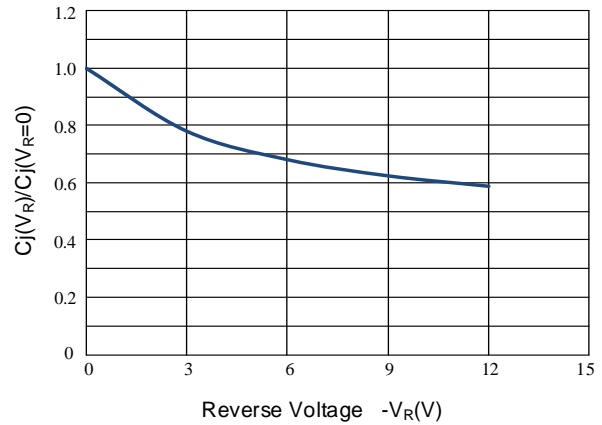

Figure 5: TLP Positive I-V Curve

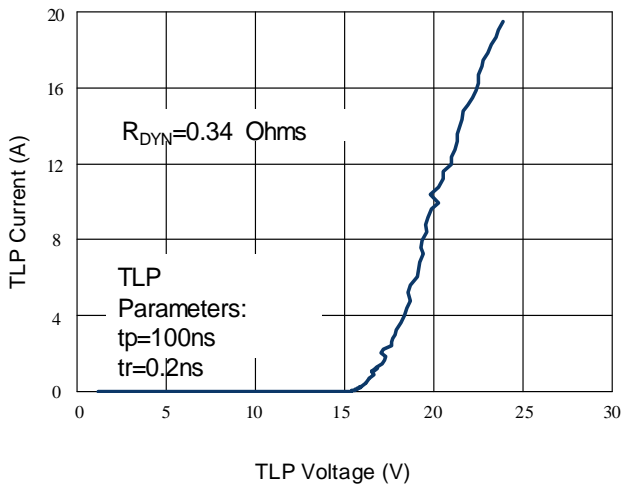
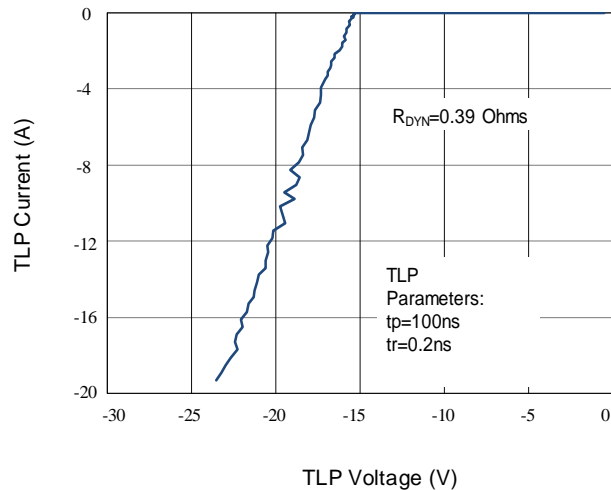
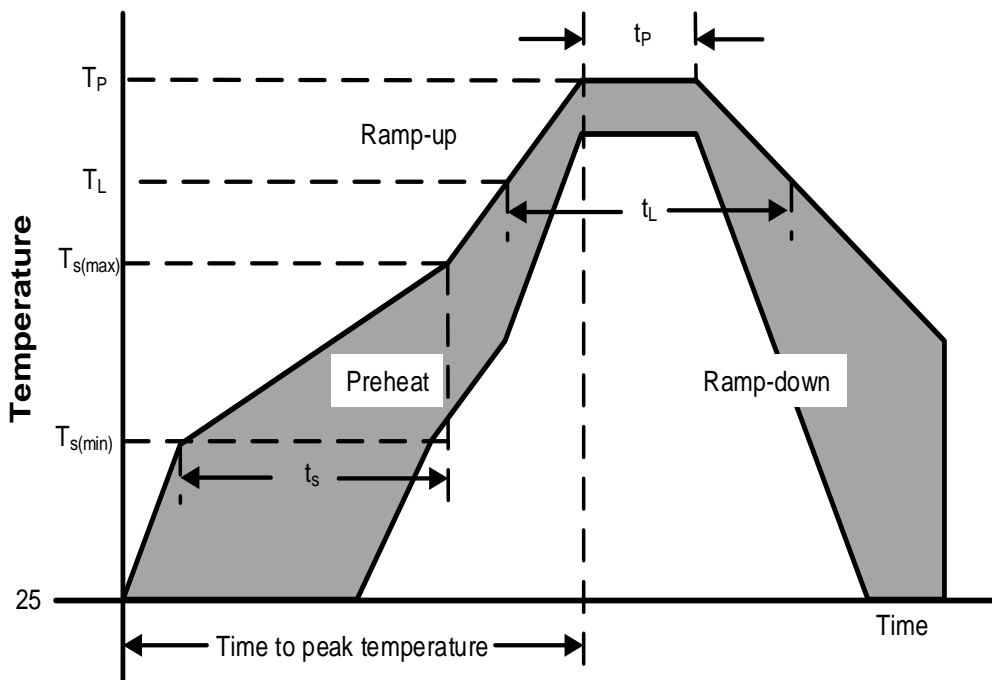

Figure 6: TLP Negative I-V Curve



Soldering Parameters

| Reflow Condition | | Pb – Free assembly |
|--|----------------------------------|--------------------|
| Pre Heat | Temperature Min ($T_{s(min)}$) | 150°C |
| | Temperature Max ($T_{s(max)}$) | 200°C |
| | Time (min to max) (t_s) | 60 – 190 secs |
| Average ramp up rate (Liquidus Temp) (T_L) to peak | | 5°C/second max |
| $T_{s(max)}$ to T_L — Ramp-up Rate | | 5°C/second max |
| Reflow | Temperature (T_L) (Liquidus) | 217°C |
| | Temperature (t_L) | 60 – 150 seconds |
| Peak Temperature (T_P) | | 260+0/-5 °C |
| Time within actual peak Temperature (t_p) | | 20 – 40 seconds |
| Ramp-down Rate | | 5°C/second max |
| Time 25°C to peak Temperature (T_P) | | 8 minutes Max. |
| Do not exceed | | 280°C |



Tape And Reel Information

Reel Dimensions

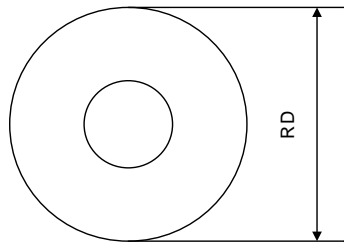

Tape Dimensions

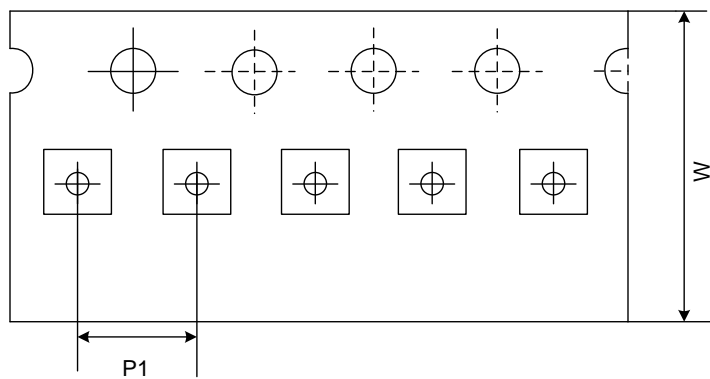

Quadrant Assignments For PIN1 Orientation In Tape

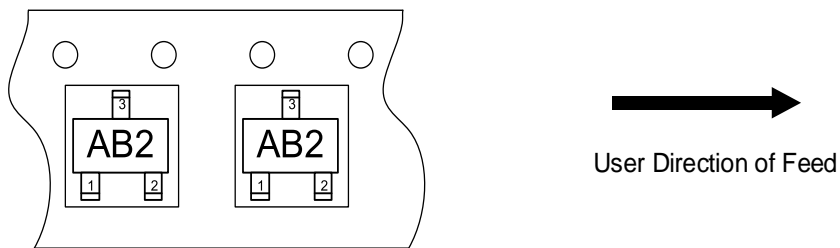

| | | |
|----|---|--------|
| RD | Reel Dimensions | 7 inch |
| W | Overall width of the carrier tape | 8 mm |
| P1 | Pitch between successive cavity centers | 4mm |

Outline Drawing – SOT-23

PACKAGE OUTLINE

SOT-23

| SYMBOL | MILLIMETERS | | INCHES | |
|--------|-------------|------|-----------|-------|
| | MIN | MAX | MIN | MAX |
| A | 0.90 | 1.15 | 0.035 | 0.045 |
| A1 | 0.00 | 0.10 | 0.000 | 0.004 |
| A2 | 0.60 | 0.70 | 0.024 | 0.028 |
| b | 0.30 | 0.50 | 0.012 | 0.020 |
| c | 0.08 | 0.15 | 0.003 | 0.006 |
| D | 2.80 | 3.00 | 0.110 | 0.118 |
| E | 2.25 | 2.55 | 0.089 | 0.100 |
| E1 | 1.20 | 1.40 | 0.047 | 0.055 |
| e | 0.95 BSC | | 0.037 BSC | |
| e1 | 1.80 | 2.00 | 0.071 | 0.079 |
| L | 0.30 | 0.50 | 0.012 | 0.020 |
| θ | 0 | 8° | 0 | 8° |

| DIMENSIONS | | |
|------------|-----------|-------------|
| DIM | INCHES | MILLIMETERS |
| M | 0.0795 | 2.02 |
| C | 0.0315 | 0.80 |
| Z | 0.111 | 2.82 |
| e | 0.037 BSC | 0.95 BSC |
| e1 | 0.075 BSC | 1.9 BSC |
| b | 0.0315 | 0.80 |

Notes:
Controlling Dimension: Millimeter.

Marking Codes

| | |
|--------------|----------|
| Part Number | WS1219PT |
| Marking Code | |

Package Information

Qty: 3k/Reel

CONTACT INFORMATION

No.1001, Shiwan(7) Road, Pudong District, Shanghai, P.R.China.201207
 Tel: 86-21-68969993 Fax: 86-21-50757680 Email: market@way-on.com
 WAYON website: <http://www.way-on.com>
 For additional information, please contact your local Sales Representative.

WAYON ® is registered trademark of Wayon Corporation.

Specifications are subject to change without notice...
 The device characteristics and parameters in this data sheet can and do vary in different applications and actual device performance may vary over time...
 Users should verify actual device performance in their specific applications...

单击下面可查看定价，库存，交付和生命周期等信息

[>>WAY-ON\(维安\)](#)