



WSxxP30SMC(-B)-AT

Automotive Load Dump Protection TVS

Features

- 3000 watts Peak Pulse Power (10/1000 μ s)
- Unidirectional and Bidirectional Protection
- Fast Response Time : Typically < 1ns
- Excellent Clamping Capability
- Built-in Strain relief
- Low inductance
- Low profile package
- High temperature solder:260°C/10 seconds at terminal
- AEC-Q101 compliant

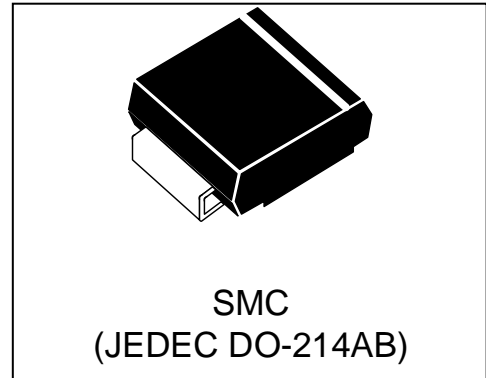

Mechanical Characteristics

- JEDEC DO-214AB package
- Molding compound flammability rating: UL 94V-0
- Marking : Marking Code
- Packaging : Tape and Reel per EIA 481
- RoHS Compliant

Applications

- Auto power system
- Car audio and video
- Automotive instrument
- Car GPS
- Can-bus

Absolute Maximum Rating

Rating	Symbol	Value	Units
Peak Pulse Power (tp =10/1000 μ s) (see Note1&2)	P _{PPM}	3000	Watts
Peak pulse current (10/1000 μ s) (see Note2)	I _{PPM}	See Electrical Characteristics	A
Power Dissipation on infinite heat sink T _L = 50 °C (Fig 4)	P _D	6.5	W
Operating Junction Temperature range	T _J	-65 to + 150	°C
Storage Temperature range	T _{STG}	-65 to + 150	°C

Note1: Peak Pulse Power Rating as Pulse Width ,per Fig1.

Note2: Peak Pulse Power or Current Derated above T_A=25°C Per Fig. 2 and Non-Repetitive Current Pulse, Per Fig.3.

Electrical Characteristics

Part Number		Marking		Reverse Stand off Voltage V_{RWM} (Volts)	Breakdown Voltage $V_{BR}@I_T$ (Volts)		Test Current I_T (mA)	Maximum Clamping Voltage $V_c@I_{FP}$ (Volts)	Maximum Peak Pulse Current I_{PP} (Amps)	Maximum Reverse Leakage $I_R@V_{RWM}$ (μ A)
UNI-POLAR	BI-POLAR	UNI-POLAR	BI-POLAR		MIN	MAX				
WS15P30SMC-AT	WS15P30SMC-B-AT	DYLP	DZLP	15	16.70	18.50	1	24.4	123.0	2
WS16P30SMC-AT	WS16P30SMC-B-AT	DYLQ	DZLQ	16	17.80	19.70	1	26.0	115.4	2
WS18P30SMC-AT	WS18P30SMC-B-AT	DYLS	DZLS	18	20.00	22.10	1	29.2	102.7	2
WS20P30SMC-AT	WS20P30SMC-B-AT	DYMY	DZMZ	20	22.20	24.50	1	32.4	92.6	2
WS22P30SMC-AT	WS22P30SMC-B-AT	DYMM	DZMM	22	24.40	26.90	1	35.5	84.5	2
WS24P30SMC-AT	WS24P30SMC-B-AT	DYMO	DZMO	24	26.70	29.50	1	38.9	77.1	2
WS26P30SMC-AT	WS26P30SMC-B-AT	DYMQ	DZMQ	26	28.90	31.90	1	42.1	71.3	2
WS28P30SMC-AT	WS28P30SMC-B-AT	DYMS	DZMS	28	31.10	34.40	1	45.4	66.1	2
WS30P30SMC-AT	WS30P30SMC-B-AT	DYNY	DZNY	30	33.30	36.80	1	48.4	62.0	2
WS33P30SMC-AT	WS33P30SMC-B-AT	DYNN	DZNN	33	36.70	40.60	1	53.3	56.3	2
WS36P30SMC-AT	WS36P30SMC-B-AT	DYNQ	DZNQ	36	40.00	44.20	1	58.1	51.6	2
WS40P30SMC-AT	WS40P30SMC-B-AT	DYOY	DZOY	40	44.40	49.10	1	64.5	46.5	2
WS43P30SMC-AT	WS43P30SMC-B-AT	DYON	DZON	43	47.80	52.80	1	69.4	43.2	2

Typical Characteristics

Figure 1. Peak Pulse Power Rating Curve

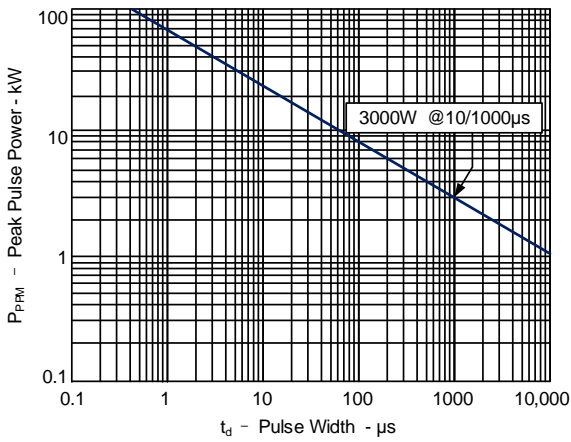

Figure 2. Pulse Derating Curve

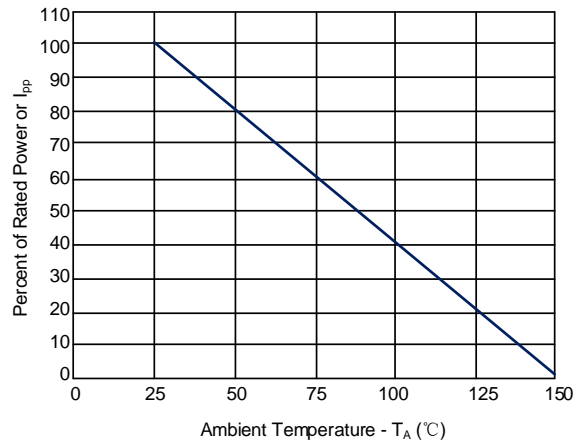

Figure 3. Pulse Waveform

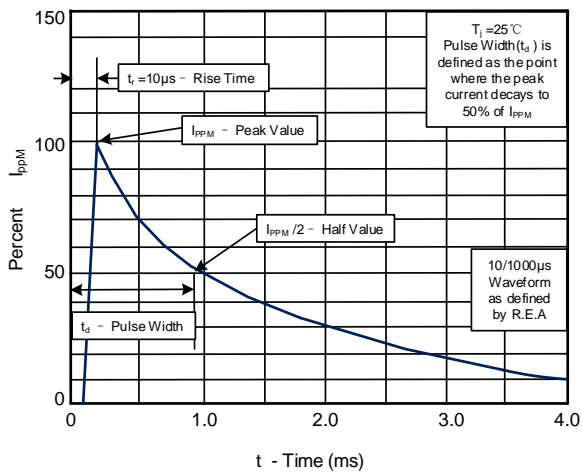
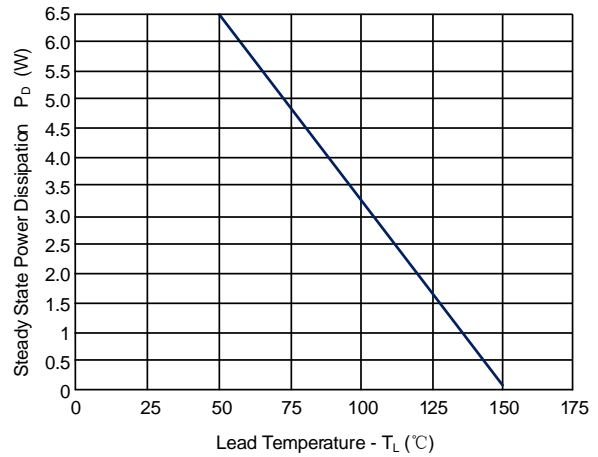
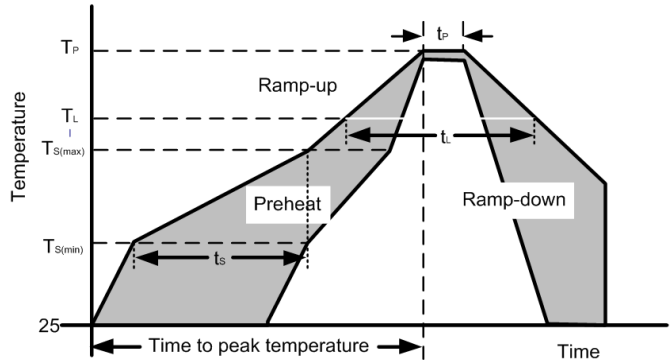

Figure 4. Steady State Power Dissipation Derating Curve



Soldering Parameters

Reflow Condition		
Pre Heat	Temperature Min ($T_{s(min)}$)	150°C
	Temperature Max ($T_{s(max)}$)	200°C
	Time (min to max) (t_s)	60-190 s
Average ramp up rate (Liquidus Temp) (T_L) to peak		3°C/s max
Ts(max) to TL - Ramp-up Rate		3°C/s max
Reflow	Temperature (T_L) (Liquidus)	217°C
	Temperature (t_L)	60-150 s
Peak Temperature (T_P)		260 ^{+0/-5} °C
Time within actual peak Temperature (t_p)		20-40 s
Ramp-down Rate		6°C/s max
Time 25°C to peak Temperature (T_P)		8 minutes max
Do not exceed		260°C



Outline Drawing – SMC (DO-214AB)

Ref. (mm)	Millimeters	
	Min.	Max.
A	2.06	2.70
A1	-	0.30
B	2.90	3.20
E	6.60	7.40
E1	7.75	8.13
D	5.59	6.22
L	0.76	1.52

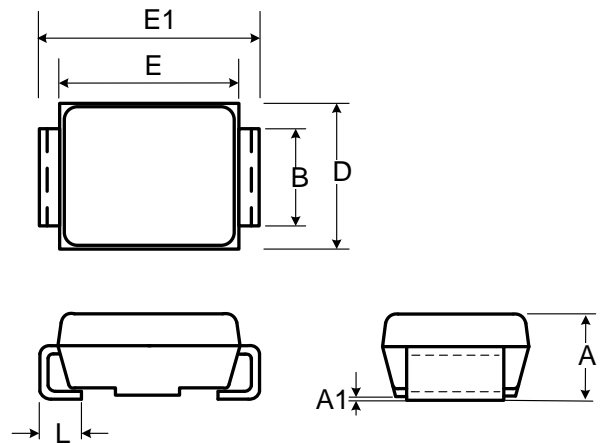

Recommended Solder Pad Layout

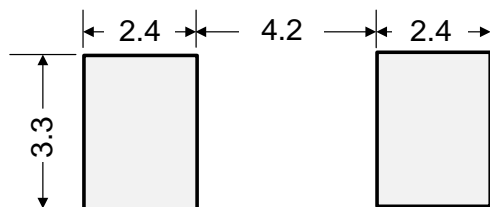

Dimensions in mm

Part Numbering System

Part Marking System

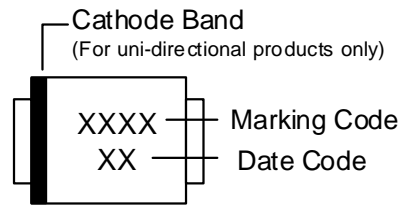
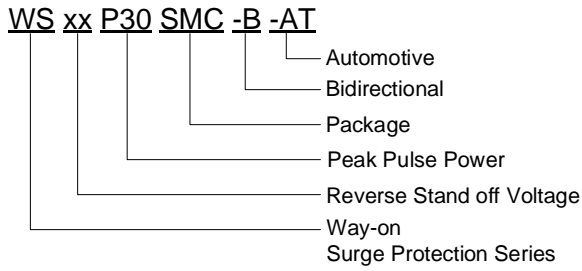

Package Information

Package Type	Description	Quantity (pcs)
SMC(DO-214AB)	Tape & Reel -16mm/13" tape	3000

Contact Information

No.1001, Shiwan(7) Road, Pudong District, Shanghai, P.R.China.201207
 Tel: +86-21-68969993 Fax: 86-21-50757680 Email: market@way-on.com
 WAYON website: <http://www.way-on.com>

For additional information, please contact your local Sales Representative.

WAYON® is registered trademarks of Wayon Corporation.

*Specifications are subject to change without notice.
 The device characteristics and parameters in this data sheet can and do vary in different applications and actual device performance may vary over time.
 Users should verify actual device performance in their specific applications.*

单击下面可查看定价，库存，交付和生命周期等信息

[>>WAY-ON\(维安\)](#)