

## 1500V 4A 5.4Ω N-ch Power MOSFET

### Description

WMOS™ D1 is Wayon's 1<sup>st</sup> generation VDMOS family that is dramatic reduction in on-resistance and ultra-low gate charge for applications requiring high power density and high efficiency. And it is very robust and RoHS compliant.

### Features

- Typ. $R_{DS(on)}=5.4\Omega@V_{GS}=10V$
- 100% avalanche tested
- Pb-free, Halogen free

### Applications

- SMPS
- Charger
- DC-DC

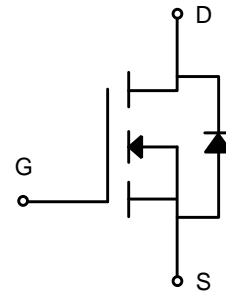
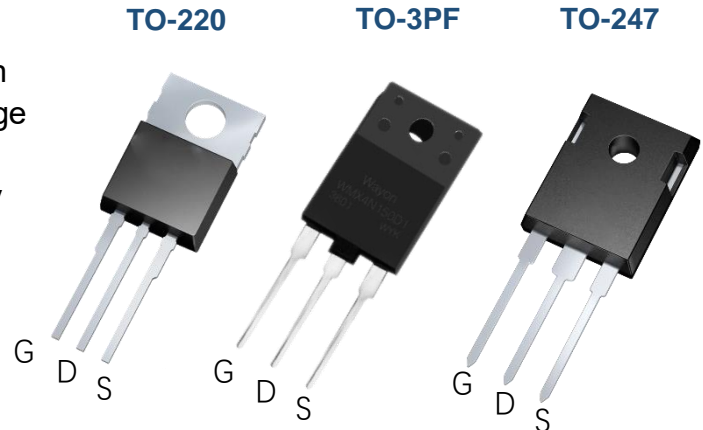

### AbsoluteMaximum Ratings (T<sub>c</sub>=25°C)

Parameter	Symbol	WMK4N150D1	WMX4N150D1	WMJ4N150D1	Unit
Drain-source voltage	V <sub>DSS</sub>		1500		V
Gate-Source Voltage	V <sub>GS</sub>		±30		V
Continuous drain current	I <sub>D</sub>		4		A
Pulsed draincurrent	I <sub>DM</sub>		16		A
Avalanche energy, single pulse	E <sub>AS</sub>		350		mJ
Power dissipation	P <sub>D</sub>	125	90	125	W
Derate above 25°C		1	0.72	1	W/°C
Operating Junction Temperature	T <sub>j</sub>		-55~150		°C
Storage Temperature	T <sub>stg</sub>		-55~150		°C
Continuous diodeforward current	I <sub>S</sub>		4		A
Diodepulsecurrent	I <sub>Spulse</sub>		16		A
Insulation withstand voltage (RMS) from all three leads to external heat sink (t=1s, T <sub>c</sub> =25°C)	V <sub>ISO</sub>		3500		V

### Thermal Characteristic

Thermal resistance, junction-to-case	$R_{\theta JC}$	1	1.38	1	$^{\circ}C/W$
Thermal resistance, junction-to-ambient	$R_{\theta JA}$	65	50	50	$^{\circ}C/W$

### Electrical Characteristics of MOSFET

				Min.	Typ.	Max.	
Drain-Source Breakdown Voltage	$BV_{DSS}$	$I_D=250\mu A, V_{GS}=0V$	$T_C=25^{\circ}C$	1500	-	-	V
Gate threshold voltage	$V_{GS(th)}$	$I_D=250\mu A, V_{DS}=V_{GS}$	$T_J=25^{\circ}C$	2.5	3.5	4.5	V
Drain-Source Leakage Current	$I_{DSS}$	$V_{DS}=1500V, V_{GS}=0V$	$T_J=25^{\circ}C$	-	-	1	$\mu A$
		$V_{DS}=1200V, V_{GS}=0V$	$T_J=125^{\circ}C$	-	-	500	$\mu A$
Gate-Source leakage current, forward	$I_{GSSF}$	$V_{DS}=0V, V_{GS}=30V$	$T_J=25^{\circ}C$	-	-	100	nA
Gate-Source leakage current, reverse	$I_{GSSR}$	$V_{DS}=0V, V_{GS}=-30V$	$T_J=25^{\circ}C$	-	-	-100	nA
Drain-Source On-State Resistance	$R_{DS(on)}$	$V_{GS}=10V, I_D=2A$	$T_J=25^{\circ}C$	-	5.4	8	$\Omega$
Transconductance	$G_{fs}$	$V_{DS}=20V$	$T_J=25^{\circ}C$	-	5.7	-	S

### Dynamic Characteristics of MOSFET ( $T_C=25^{\circ}C$ )

				Min.	Typ.	Max.	
Input Capacitance	$C_{iss}$	$f=1MHz, V_{DS}=25V, V_{GS}=0V$		-	1800	-	pF
Output Capacitance	$C_{oss}$			-	100	-	pF
Reverse Transfer Capacitance	$C_{riss}$			-	11	-	pF
Gate to Source Charge	$Q_{gs}$	$V_{DD}=750V$		-	8	-	nC
Gate to Drain Charge	$Q_{gd}$	$I_D=4A$		-	15	-	nC
Total Gate charge	$Q_g$	$V_{GS}=0$ to 10V		-	41	-	nC

### Switching Characteristics of MOSFET ( $T_C=25^{\circ}C$ )

				Min.	Typ.	Max.	
Turn-on delay time	$t_{d on}$	$V_{DS}=750V, I_D=4A, R_G=4.7\Omega, V_{GS}=0$ to 10V		-	18	-	ns
Rise time	$t_r$			-	10	-	ns
Turn-off delay time	$t_{d off}$			-	40	-	ns
Fall time	$t_f$			-	30	-	ns

### Characteristics of Body Diode ( $T_C=25^{\circ}C$ )

				Min.	Typ.	Max.	
Forward voltage	$V_{SD}$	$I_{SD}=4A, V_{GS}=0V$		-	-	1.5	V
Reverse recovery time	$t_{rr}$	$V_{DS}=750V, I_F=4A, V_{GS}=0V$ $-di/dt=100A/\mu s$		-	274	-	ns
Reverse recovery current	$I_{rr}$			-	10	-	A
Recovery charge	$Q_{rr}$			-	1.35	-	$\mu C$

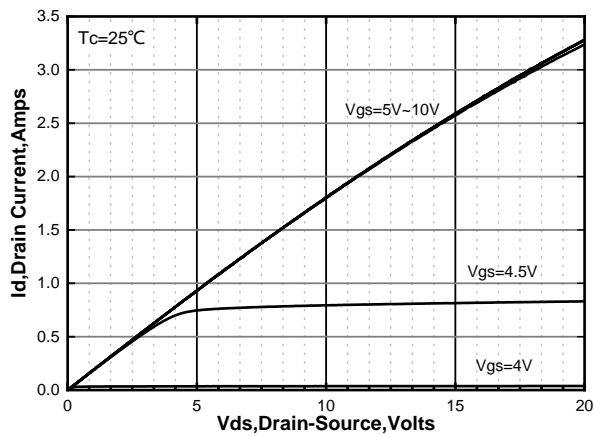

Figure 1. On-Region Characteristics

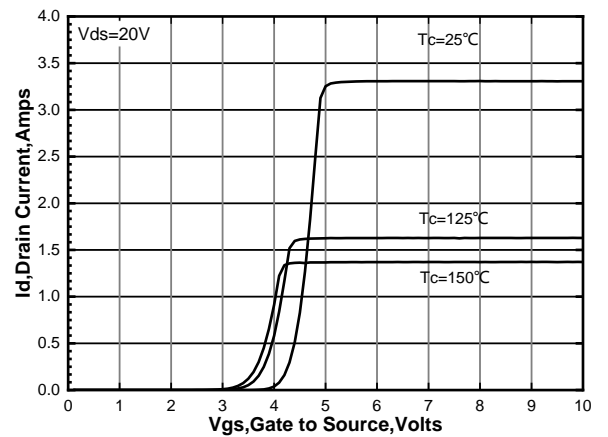

Figure 2. Transfer Characteristics

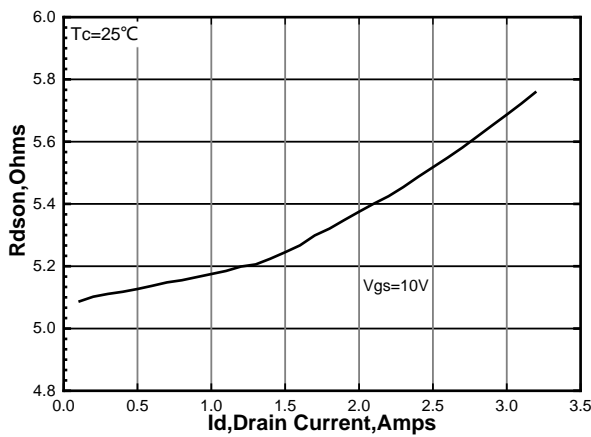

Figure 3. Static Drain-Source On Resistance

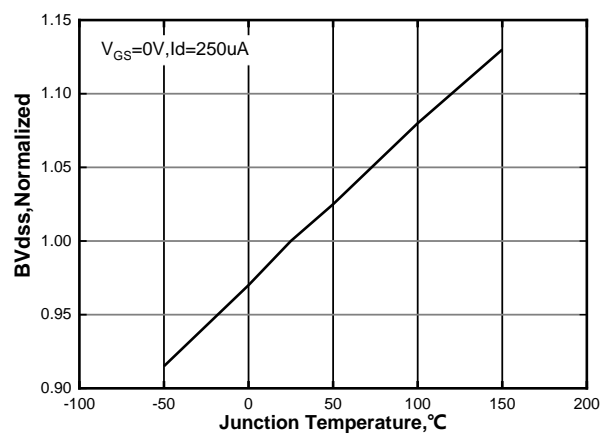

Figure 4. Normalized  $BV_{DSS}$  vs. Temperature

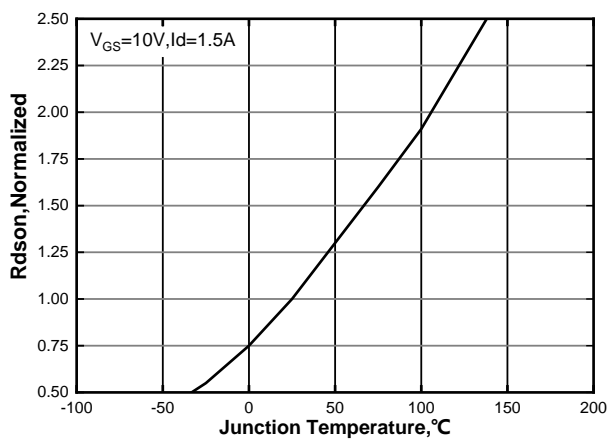

Figure 5. Normalized  $R_{DS(on)}$  vs. Temperature

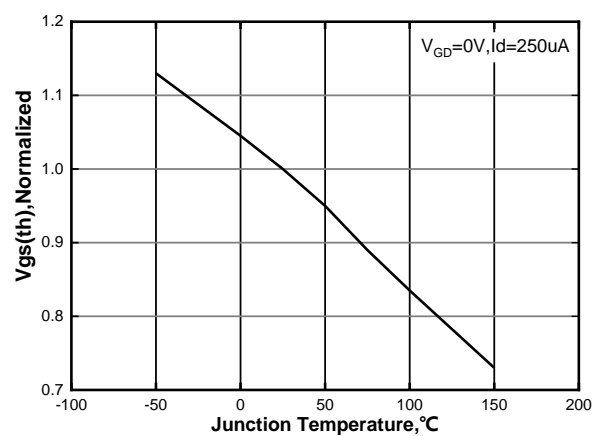

Figure 6. Normalized  $V_{GS(th)}$  vs. Temperature

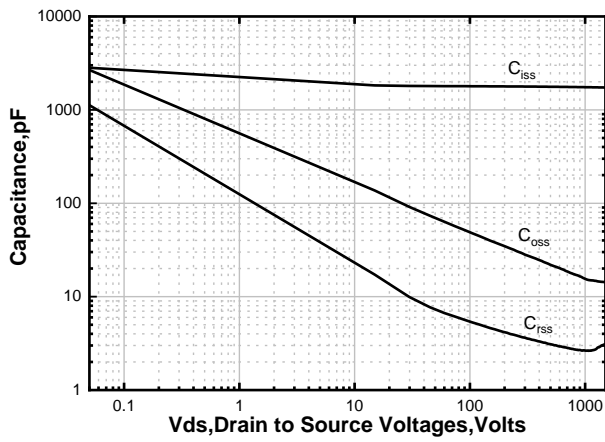

Figure 7. Capacitance Characteristics

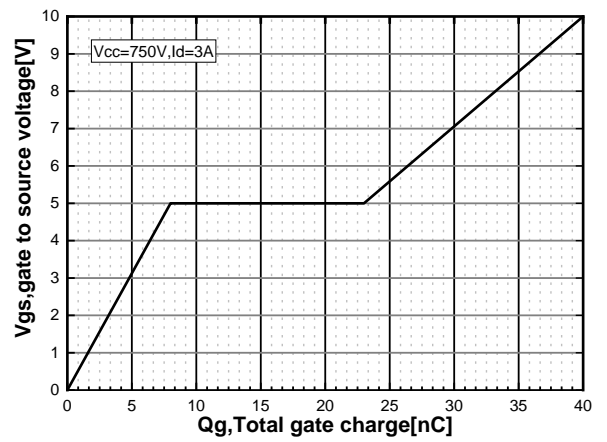

Figure 8. Gate Charge Characteristics

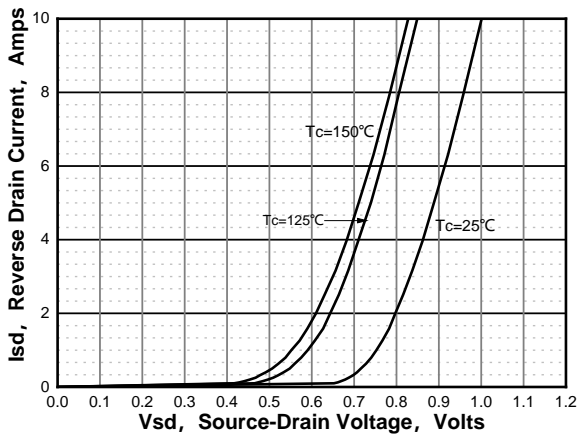

Figure 9. Typical Body Diode Transfer Characteristics

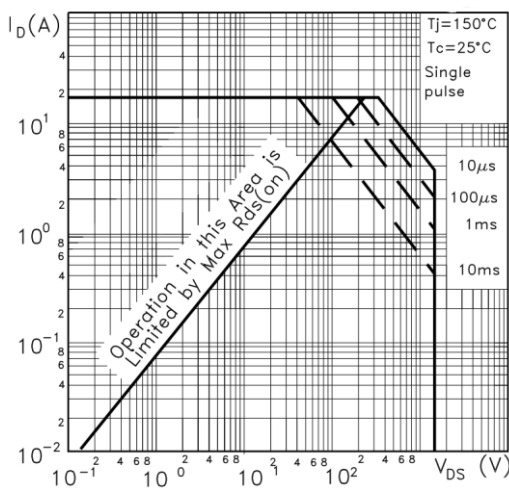

Figure 10. Maximum Safe Operating Area (TO-220)

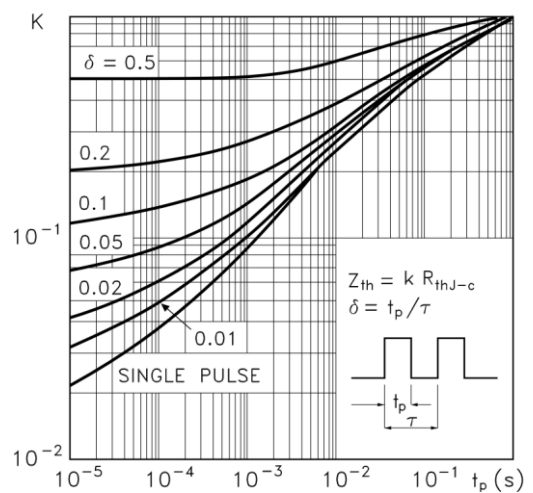

Figure 11. Transient Thermal Response Curve (TO-220)

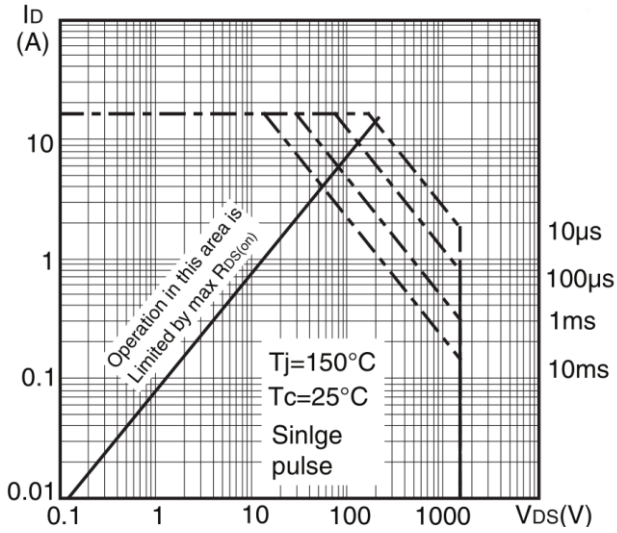

Figure 12. Maximum Safe Operating Area(TO-3PF)

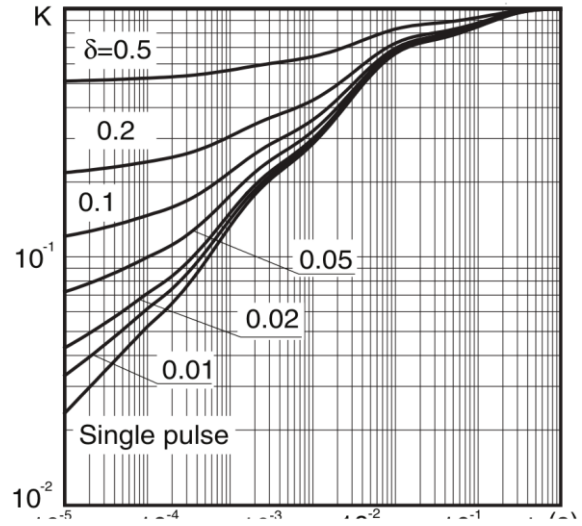

Figure 13. Transient Thermal Response Curve (TO-3PF)

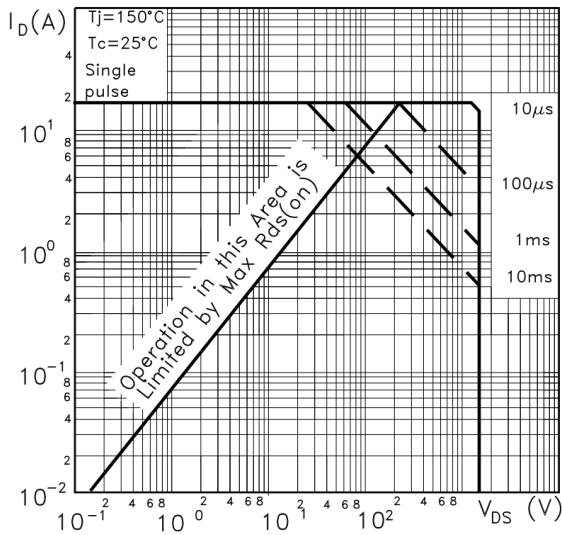

Figure 13. Maximum Safe Operating Area(TO-247)

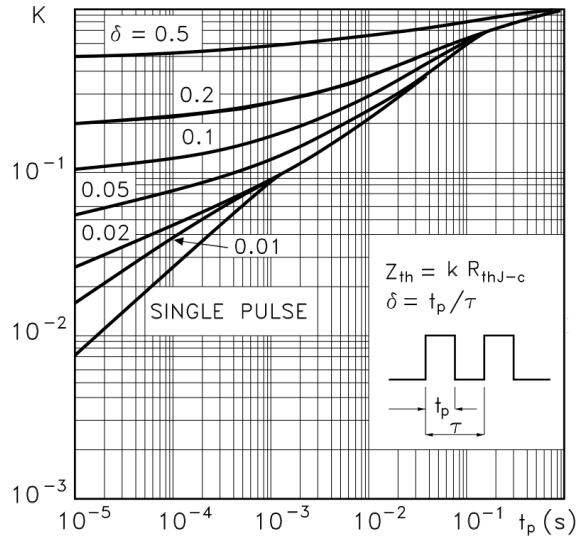
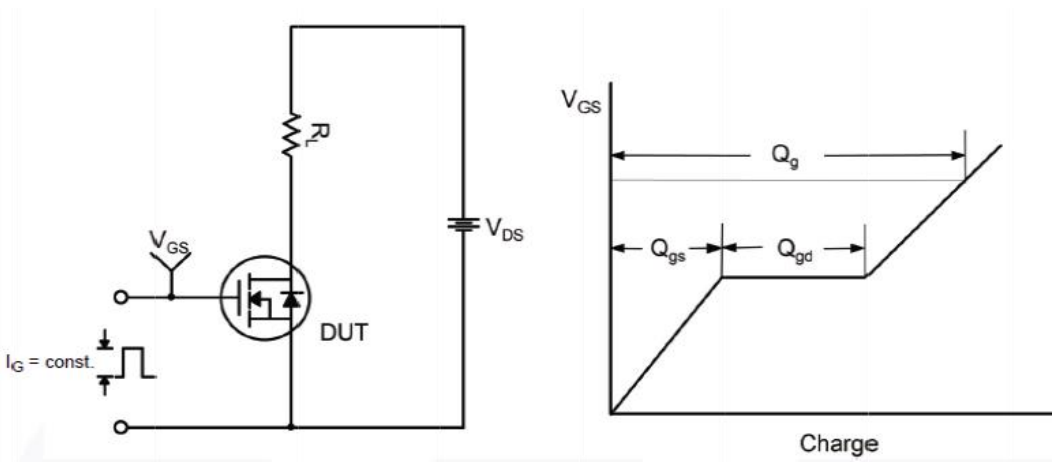
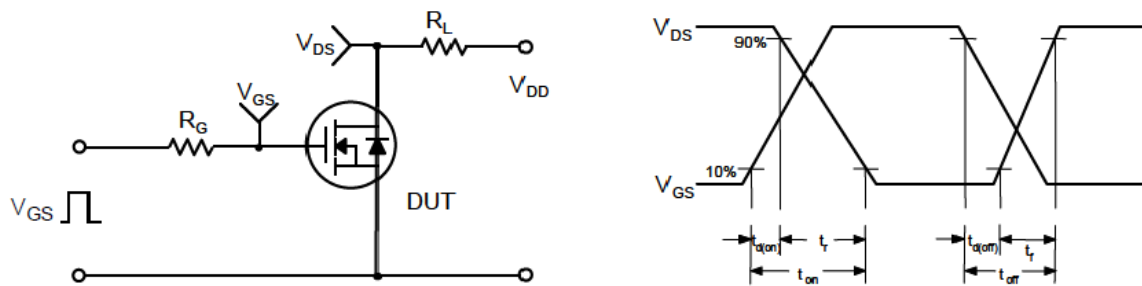

Figure 14. Transient Thermal Response Curve (TO-247)

Gate Charge Test Circuit & Waveform



Switching Test Circuit & Waveforms



Unclamped Inductive Switching Test Circuit & Waveforms

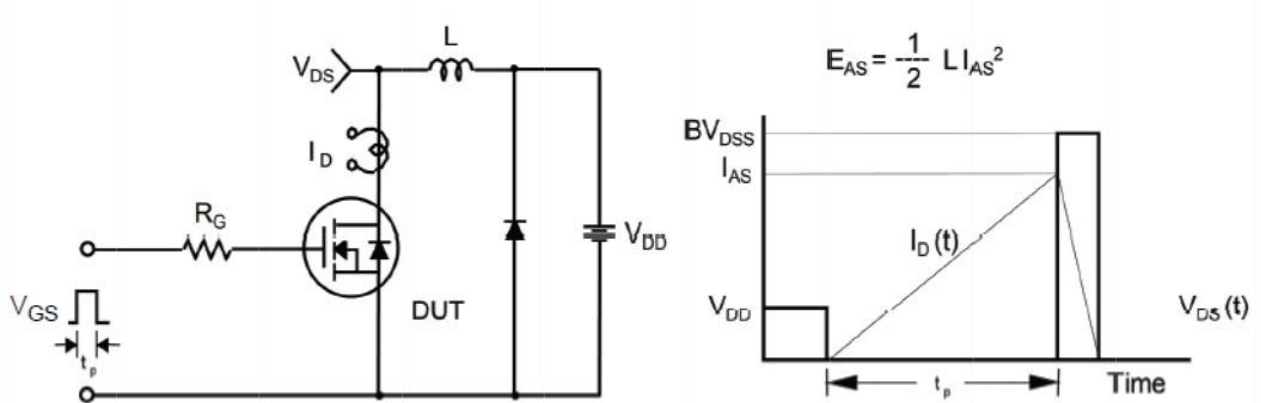

Mechanical Dimensions for TO-220

COMMON DIMENSIONS

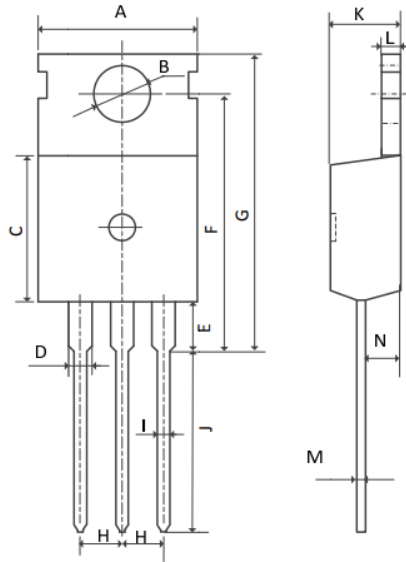

SYMBOL	MM	
	MIN	MAX
A	9.70	10.20
B	3.40	3.80
C	8.90	9.40
D	1.17	1.47
E	2.60	3.40
F	15.10	16.70
G	19.55MAX	
H	2.54REF	
I	0.70	0.95
J	9.35	11.00
K	4.30	4.77
L	1.20	1.45
M	0.40	0.65
N	2.20	2.60

Mechanical Dimensions for TO-3PF

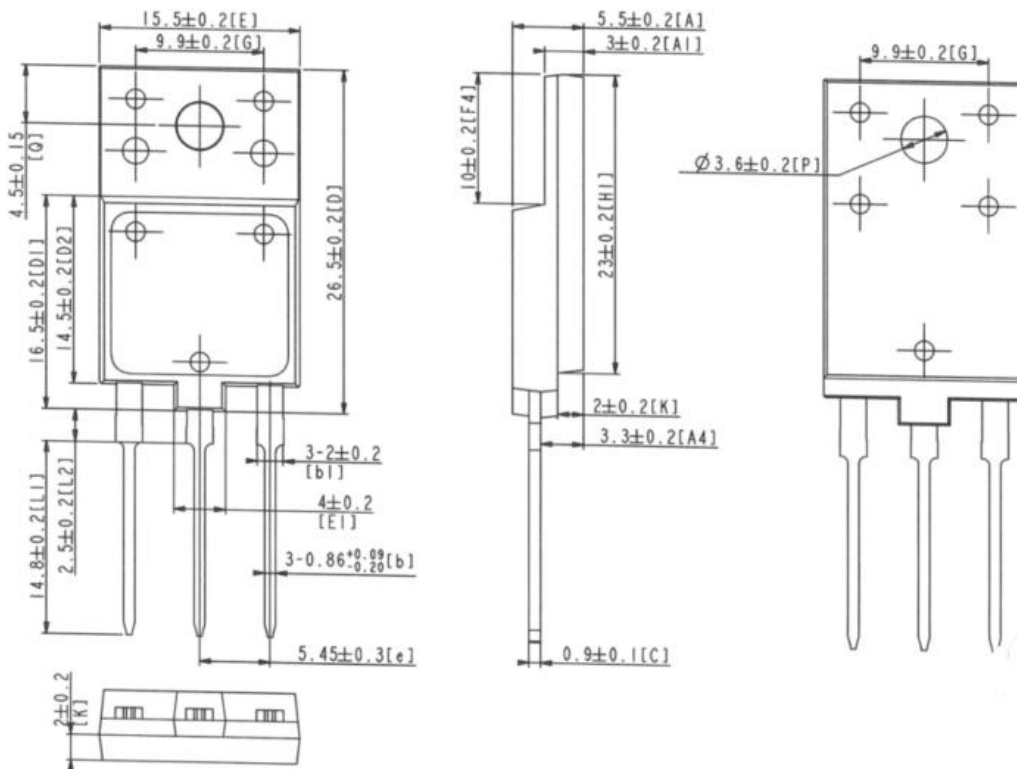

### Mechanical Dimensions for TO-247

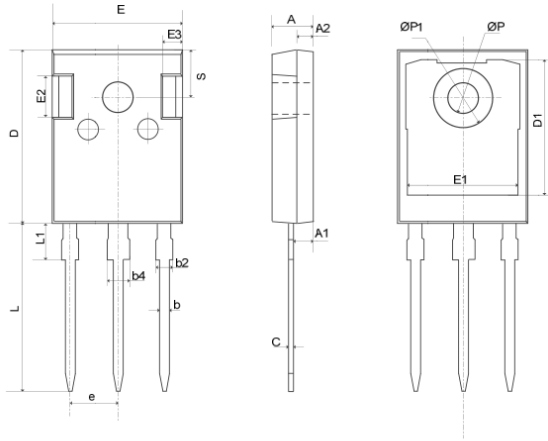

COMMON DIMENSIONS

SYMBOL	MM	
	MIN	MAX
A	4.80	5.20
A1	2.21	2.61
A2	1.85	2.15
b	1.11	1.36
b2	1.91	2.21
b4	2.91	3.21
c	0.51	0.75
D	20.70	21.30
D1	16.25	16.85
E	15.50	16.10
E1	13.00	13.60
E2	4.80	5.20
E3	2.30	2.70
e	5.44BSC	
L	19.62	20.22
L1	—	4.30
ØP	3.40	3.80
ØP1	—	7.30
S	6.15BSC	

### Ordering Information

Part	Package	Marking	Packing method
WMK4N150D1	TO-220	WMK4N150D1	Tube
WMX4N150D1	TO-3PF	WMX4N150D1	Tube
WMJ4N150D1	TO-247	WMJ4N150D1	Tube

### Marking Information

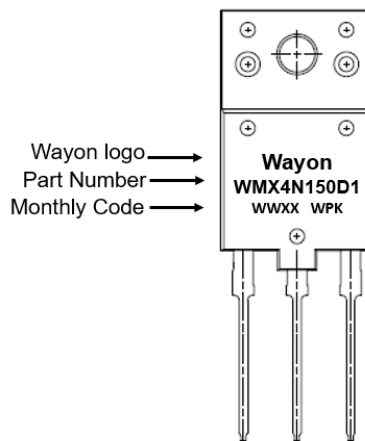



## Contact Information

No.1001, Shiwan(7) Road, Pudong District, Shanghai, P.R.China.201202

Tel: 86-21-50310888 Fax: 86-21-50757680 Email: [market@way-on.com](mailto:market@way-on.com)

WAYON website: <http://www.way-on.com>

For additional information, please contact your local Sales Representative.

 **WAYON**® is registered trademarks of Wayon Corporation.

## Disclaimer

WAYON reserves the right to make changes without further notice to any Products herein to improve reliability, function, or design. The Products are not designed for use in hostile environments, including, without limitation, aircraft, nuclear power generation, medical appliances, and devices or systems in which malfunction of any Product can reasonably be expected to result in a personal injury. The information given in this document shall in no event be regarded as a guarantee of conditions or characteristics. WAYON does not assume any liability for infringement of patents, copyrights, or other intellectual property rights of third parties by or arising from the use of Products or technical information described in this document.

单击下面可查看定价，库存，交付和生命周期等信息

[>>WAY-ON\(维安\)](#)