

## ● 1. General Description

---

The WP250151T5-B is a current limited P-channel MOSFET power switch designed for high-side load switching applications. This switch operates with inputs ranging from 2.5V to 5.2V, making it ideal for both 3.3V and 5V systems. An integrated current-limiting circuit protects the input supply against large currents which may cause the supply to fall out of regulation. The WP250151T5-B includes thermal shutdown protection that prevents damage to the device when a continuous over-current condition causes excessive heating by turning off the switch. The load of the switch can be up to 0.15A. The quiescent current is only 100µA in active mode while it is less than 1µA in shutdown mode. Fault flag ( $\overline{\text{FLT}}$ ) can indicate over current and fault conditions. The switch has an output over-voltage protection, when this fault condition stays on for longer than 15µs, the output is disabled and shut down.

The WP250151T5-B is available in Pb-free packages and is characterized for operation over the free-air temperature range of - 40°C to 85°C.

## ● 2. Features

---

- Input Voltage Range: 2.5V to 5.2V
- 200mA Current Limit
- Reverse Current Limit
- Very Low Quiescent Current: 100µA (Typ.)
- 1µA Max Shutdown Supply Current
- Fault Flag ( $\overline{\text{FLT}}$ ) output for over current and fault conditions.
- Built-in Pull-up Resistor for EN Pin
- Automatic Output Discharge at Shutdown
- Output Over-voltage Protection
- Under-Voltage Lockout
- Thermal Shutdown
- 8kV ESD Rating
- Package: SOT23-5

## ● 3. Applications

---

- Laptop/Desktop Computers and Netbooks
- Smart Phones and PDAs
- LCD TVs and Monitors
- Set-Top-Boxes, Residential Gateways
- Printers, Docking Stations, HUBs
- USB Memory Drives
- USB Hubs

### 4. Typical Application

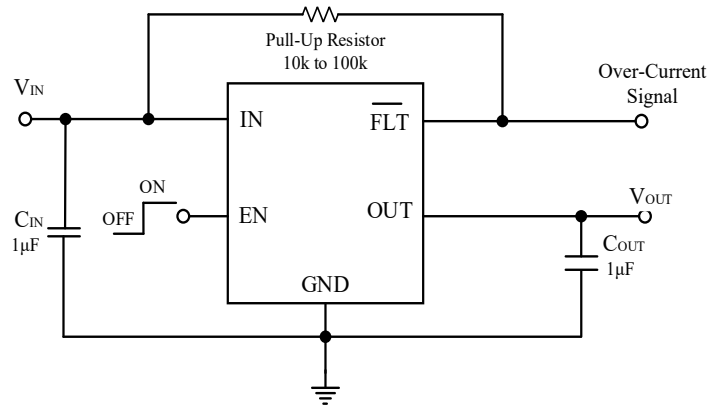

Note: Tantalum or Aluminum Electrolytic capacitors ( $C_{IN}$  and  $C_{OUT}$ ) may be required for USB applications

### 5. Pin Configuration

(Top View)

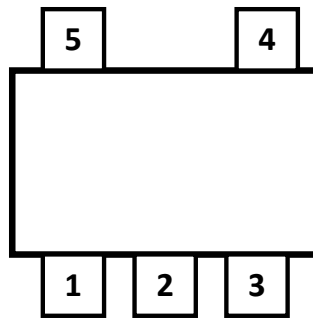

SOT23-5

### 6. Pin Description

PIN NUMBER	PIN NAME	I/O	PIN FUNCTION
1	OUT	O	Switch output.
2	GND		Common ground.
3	$\overline{\text{FLT}}$	O	Fault FLAG output. Open drain output that indicates an over current, supply under voltage or over temperature state.
4	EN	I	Enable input. Active High.
5	IN	I	Switch input.

### ● 7. Absolute Maximum Ratings

Over operating free-air temperature range (unless otherwise noted)<sup>(1)</sup>

PARAMETER	RATING	UNIT
IN, EN, $\overline{\text{FLT}}$ Voltage	-0.3 to 6	V
OUT Voltage	-0.3 to $V_{\text{IN}} + 0.3$	V
OUT Current	Internal Limited	A
Power Dissipation	400	mW
Package Thermal Resistance( $\theta_{\text{JA}}$ )	250	°C/W
Operating Junction Temperature	-40 to 125	°C
Storage Temperature	-55 to 150	°C
Lead Temperature (Soldering, 10 sec)	260	°C
ESD(HBM)	8000	V

**NOTE:** Stresses beyond those listed under Absolute Maximum Ratings may cause permanent damage to the device. These are stress ratings only, which do not imply functional operation of the device at these or any other conditions beyond those indicated under Recommended Operating Conditions. Exposure to absolute-maximum-rated conditions for extended periods may affect device reliability.

### ● 8. Recommended Operating Conditions

SYMBOL	PARAMETER	MIN	MAX	UNIT
$V_{\text{IN}}$	Input Voltage	2.5	5.2	V
$I_{\text{OUT}}$	Output Current		150	mA
$T_{\text{A}}$	Operating Ambient Temperature	-40	85	°C

## ● 9. Electrical Characteristics

( $V_{IN} = 5\text{ V}$ ,  $V_{EN} = 5\text{ V}$ ,  $C_{IN}=1\mu\text{F}$ ,  $C_{OUT}=1\mu\text{F}$ ,  $T_A=25^\circ\text{C}$ , unless otherwise noted)

SYMBOL	PARAMETER	TEST CONDITIONS	MIN	TYP.	MAX	UNIT
$I_{SHDN}$	Shutdown Quiescent Current	Disabled, OUT floating or shorted to ground		0.3	1	$\mu\text{A}$
$I_Q$	Quiescent Current	Enabled, OUT floating		100	140	$\mu\text{A}$
$R_{DS(ON)}$	Switch on-resistance	$V_{IN}=5\text{V}$ , $I_{OUT}=0.1\text{A}$	100	250	350	$\text{m}\Omega$
$I_{LIM}$	Current Limit	$V_{IN}=5\text{V}$ , $V_{OUT}=4.5\text{V}$	160	200	240	$\text{mA}$
$V_{IL}$	EN Input Logic-Low Voltage	Note 1			0.5	V
$V_{IH}$	EN Input Logic-High Voltage	Note 1	1.5			V
$R_{\overline{FLT}}$	$\overline{FLT}$ Low Resistance	Note 2		80		$\Omega$
$t_{\overline{FLT\_DELAY}}$	$\overline{FLT}$ Delay Time	Note 2		15		ms
$I_{SINK}$	EN Input leakage	$V_{EN} = 5\text{V}$		0.01	1	$\mu\text{A}$
		$V_{EN} = 0\text{V}$	-2	-0.25		$\mu\text{A}$
$V_{UVLO}$	Input UVLO Threshold	Enabled, $V_{IN}$ rising	1.4	1.8	2.2	V
$V_{UVLO\_HYS}$	Input UVLO Hysteresis			0.01		V
$I_{REV}$	Reverse Leakage Current	$V_{IN} = 0\text{V}$ , $V_{OUT} = 5\text{V}$ , $I_{REV}$ at $V_{IN}$		0.1	1	$\mu\text{A}$
$I_{ROCP}$	Reverse-Current Trigger Point	$V_{IN} = 5.0\text{V}$ , $V_{OUT} = 5.2\text{V}$		0.1		A
$t_{TRIG}$	Deglintch time from reverse current trigger to MOSFET turn off	Note 3	0.5	0.7	1.0	ms
$V_{OVP}$	Output over-voltage trip point	Note 4	5.3		5.6	V
$t_R$	Output Turn-on Rise Time	$R_{LOAD}=100\Omega$	0.2	0.4	0.8	ms

SYMBOL	PARAMETER	TEST CONDITIONS	MIN	TYP.	MAX	UNIT
R <sub>DIS</sub>	Output Discharge Resistance	Disabled, V <sub>IN</sub> = 5V, V <sub>OUT</sub> =1V,		800		Ω
T <sub>SHDN</sub>	Thermal Shutdown Threshold	Note 2		150		°C
T <sub>HYS</sub>	Thermal shutdown hysteresis	Note 2		20		°C

Note 1: EN includes a small pull-up current source, nominally 0.1μ A. When EN pin is floating, the chip is enabled.

Note 2: Guaranteed by design.

Note 3: When reverse current triggers at I<sub>ROCP</sub> = 0.10A, the reverse current is continuously clamped at I<sub>ROCP</sub> for 0.7ms deglitch time until MOSFET is turned off.

Note 4: During output over-voltage protection, the output draws approximately 60μA current.

10. Typical Performance Characteristics

( $V_{IN} = 5V$ ,  $V_{EN} = 5V$ ,  $C_{IN} = 1\mu F$ ,  $C_{OUT} = 1\mu F$ ,  $T_A = 25^\circ C$ , unless otherwise noted)

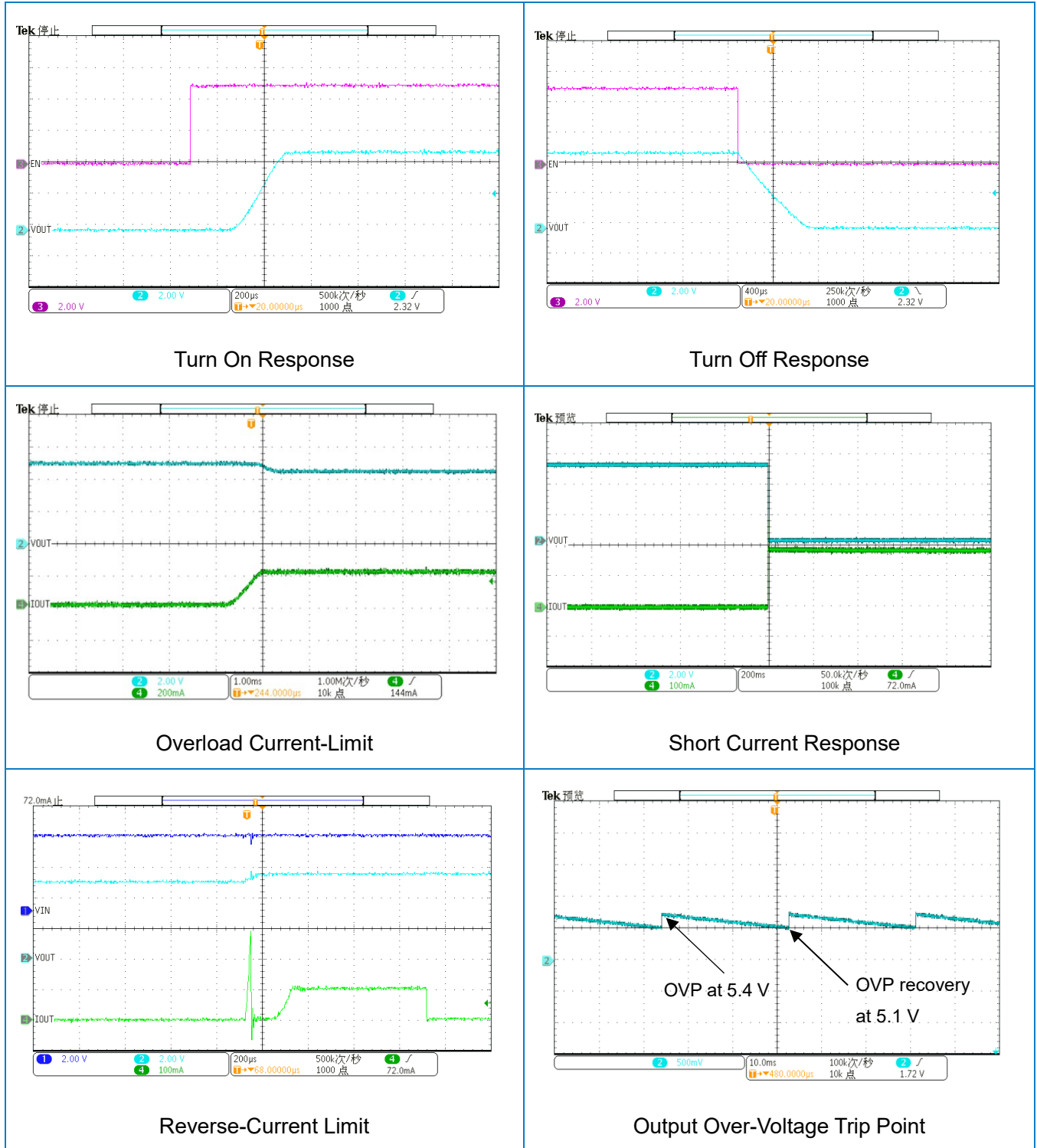

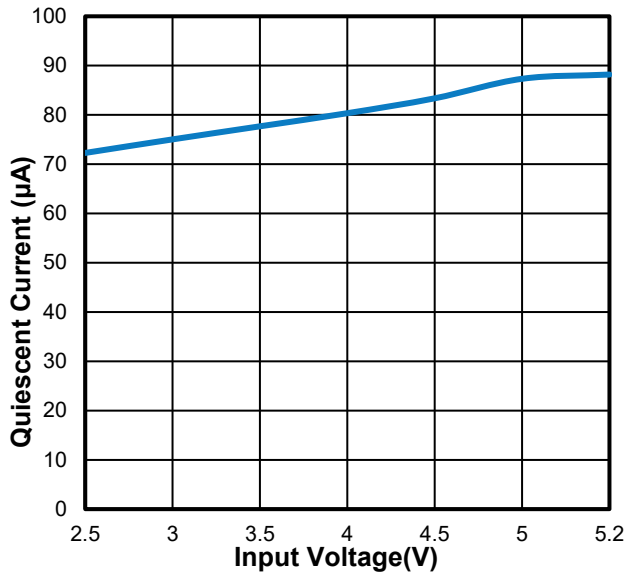

Quiescent Current vs. Input Voltage

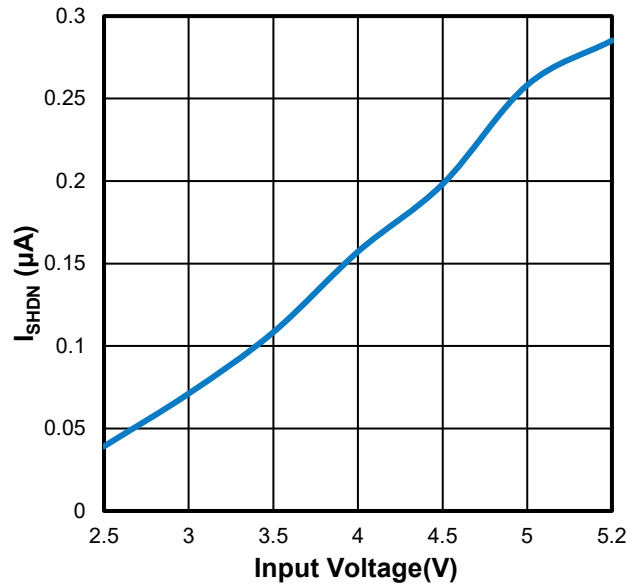

Shutdown Quiescent Current vs. Input Voltage

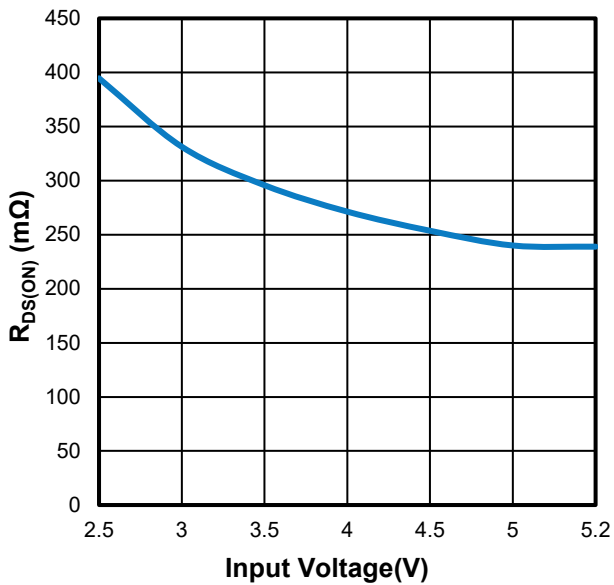

Switch On-Resistance vs. Input Voltage

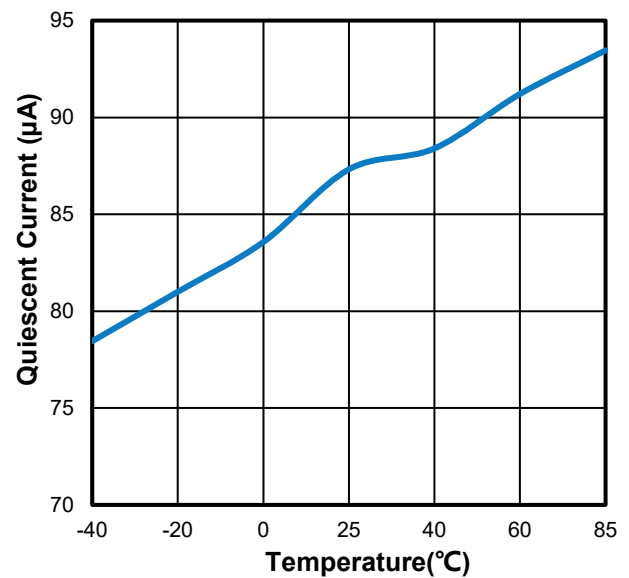

Quiescent Current vs. Ambient Temperature

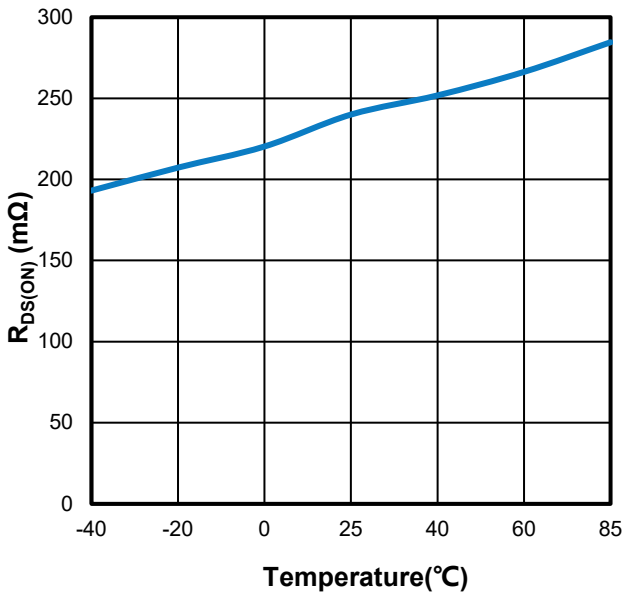

Switch On-Resistance vs. Ambient Temperature

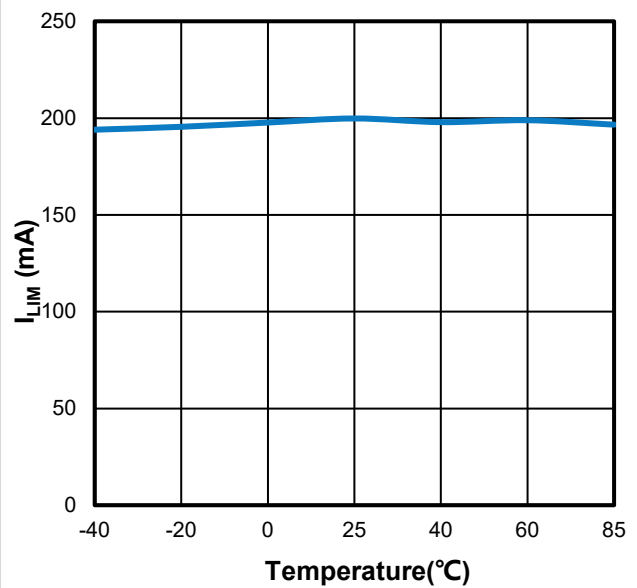

Current Limit vs. Ambient Temperature

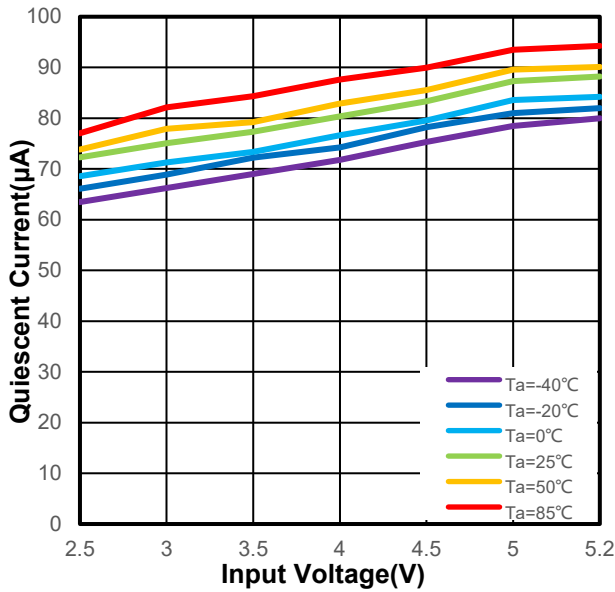

Quiescent Current vs. Input Voltage vs. Ambient Temperature

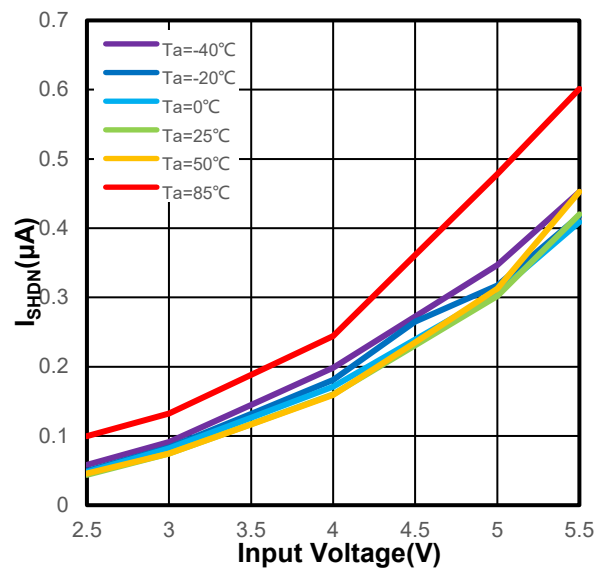

Shutdown Quiescent Current vs. Input Voltage vs. Ambient Temperature



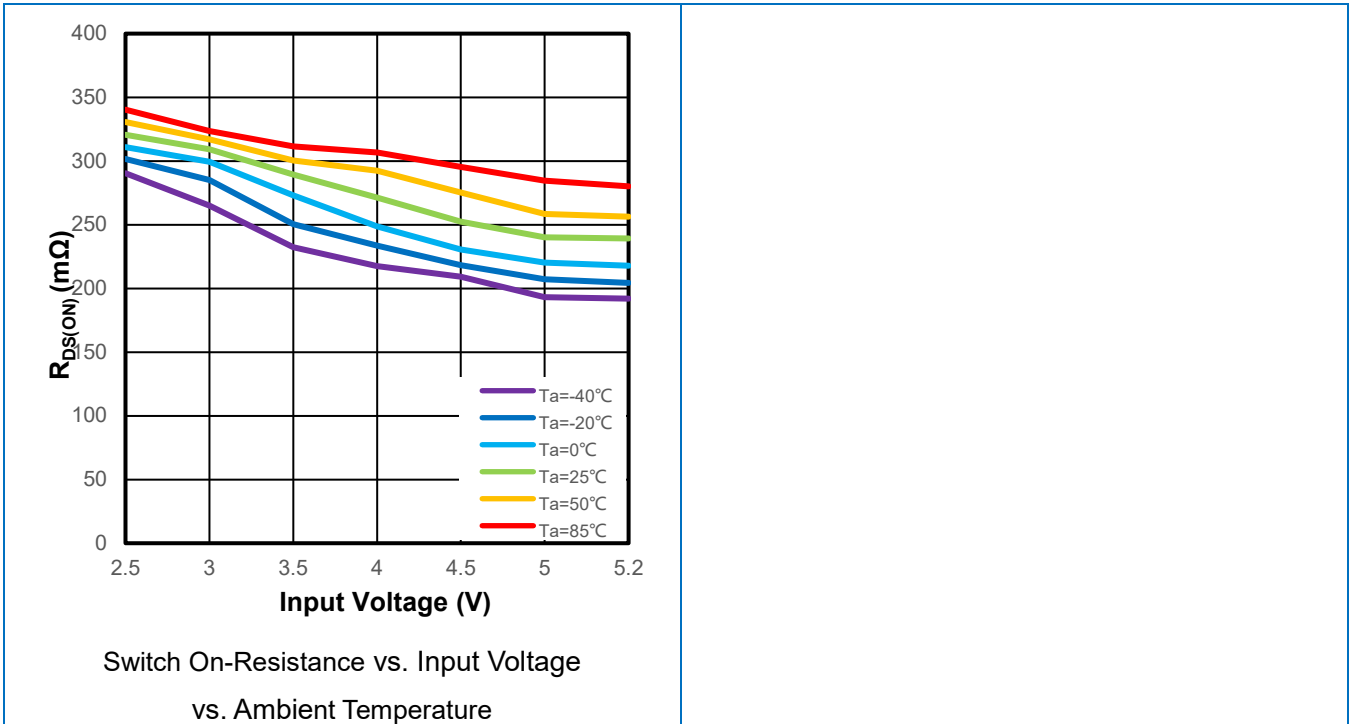

● **11. Function Description**

● **11.1 Overview**

The WP250151T5-B load switches are 5.2V, current limited load switches in a SOT23-5 package. The devices contain a 250 mΩ current-limited P-channel MOSFET that can operate over an input voltage range of 2.5 V to 5.2V. When the switch current reaches the maximum limit, the WP250151T5-B operates in a constant-current mode to prohibit excessive currents from causing damage. WP250151T5-B has a current limit of 200 mA.

● **11.2 Block Diagram**

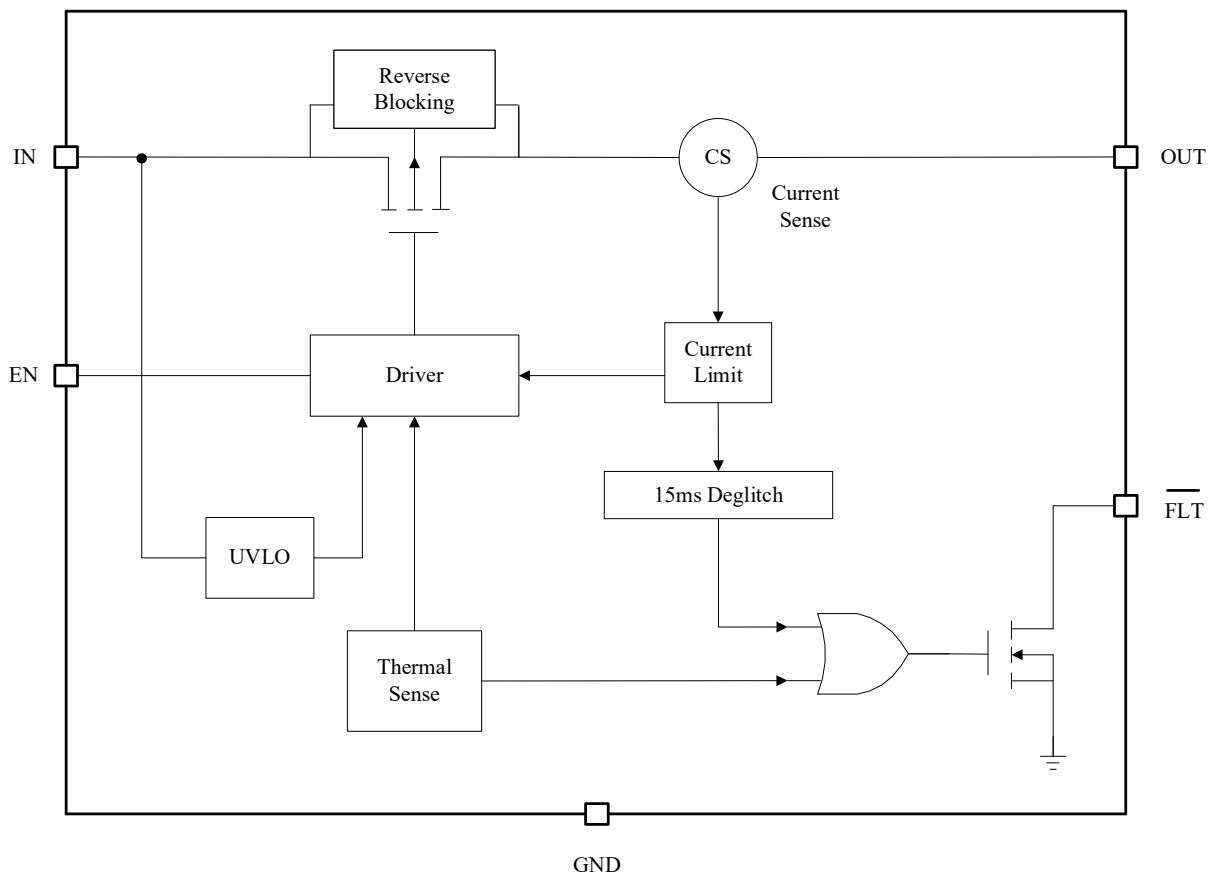

● **11.3 Feature Description**

● **11.3.1 Current Limiting**

When the switch current reaches the maximum limit, the WP250151T5-B operates in a constant-current mode to prohibit excessive currents from causing damage.

● **11.3.2 Fault Reporting**

The Fault flag ( $\overline{\text{FLT}}$ ) can indicate over current condition. Fault flag is an open drain signal and must be pulled up by a pull-up resistor. Fault flag is logic high in normal. When over current occurs, fault flag change to logic

low with a duration of at least 8ms after about 15ms delay which is guaranteed by design. Therefore fault flag is a negative pulse signal, not a level signal. A heavy load may cause a momentary over current condition, however, no false reporting occurs on  $\overline{\text{FLT}}$  due to the 15ms deglitch circuits.

- **11.3.3 Thermal Shutdown**

Thermal shutdown protects the device from internally or externally generated excessive temperatures. During an overtemperature condition the switch is turned off. The switch automatically turns on again if the temperature of the die drops below the threshold temperature.

- **11.3.4 Quick Output Discharge**

The WP250151T5-B include the Quick Output Discharge (QOD) feature, in order to discharge the application capacitor connected on OUT pin.

- **11.4 Device Functional Modes**

When the EN pin is actively pulled high and no fault conditions are present, the switch will be turned on, connecting  $V_{\text{IN}}$  to  $V_{\text{OUT}}$ . When the EN pin is actively pulled low regardless of the fault condition, the switch will be turned off. In the event that the current limit is exceeded, the device will operate in a constant-current mode until the fault condition is removed. During thermal shutdown conditions, the switch will automatically turn off and will turn back on again if the temperature of the die drops below the threshold temperature.

- **12 Application and Implementation**

---

- **12.1 Application Information**

- **12.1.1 EN Control**

The EN pin controls the state of the switch. Activating EN continuously holds the switch in the on state as long as there is no fault. An undervoltage lockout or thermal shutdown event will override the EN pin control and turn off the switch. EN is active high and has a low threshold, making it capable of interfacing with low-voltage signals.

- **12.1.2 Input Capacitor**

To limit the voltage drop on the input supply caused by transient inrush current, a capacitor 1 $\mu$ F or larger must be placed between the IN and GND pins.

- **12.1.3 Output Capacitor**

A 1 $\mu$ F or larger capacitor should be placed between the OUT and GND pins. This capacitor will prevent parasitic board inductances from forcing OUT below GND when the switch turns off.

- **12.1.4 Undervoltage Lockout**

The undervoltage lockout turns off the switch if the input voltage drops below the undervoltage lockout threshold. Under-voltage detection functions only when the switch is enabled.

### ● 12.1.5 Power Dissipation and Junction Temperature

The junction temperature of the switch depend on several factors such as the load, PCB layout, ambient temperature and package type. Power dissipation can be calculated based on the output current and the  $R_{DS(ON)}$  of the switch as below.

$$P_D = R_{DS(ON)} \times I^2$$

The junction temperature can be estimated by the following thermal equation:

$$T_J = P_D \times \theta_{JA} + T_A$$

Where:

$T_A$  = Ambient temperature

$\theta_{JA}$  = Thermal resistance

$P_D$  = Total power dissipation

With all possible conditions, the junction temperature must be within the range specified under operating conditions. The maximum output current must be derated at higher ambient temperature to ensure the junction temperature does not exceed the maximum junction temperature which is 125°C.

### ● 12.1.6 Over-Voltage Protection

The device has an output over-voltage protection that triggers when the output voltage reaches output over-voltage trip point. When this fault condition stays on for longer than 15 $\mu$ s, (This is called the "Debounce time from output over voltage to MOSFET turn off") output device is disabled and shut down. Recovery from ROVP occurs when the output voltage falls to 101% of input voltage.

### ● 12.1.7 Reverse-Current Protection

The USB specification does not allow an output device to source current back into the USB port. In a normal MOSFET switch, current will flow in reverse direction (from the output side to the input side) When the output voltage exceeds than input voltage. A reverse current limit feature is implemented in the WP250152T5-B to limit such back currents. Reverse current limit is always active. Reverse current is limited to half of the  $I_{LIM}$  level and when the fault exists for more than 700 $\mu$ s, output device is disabled and shut down. This is called the "Deglitch time from reverse current trigger to MOSFET turn off." The MOSFET will turn on again when the output voltage returns to t 101% of input voltage.

## ● 13. Power Supply Recommendations

The device is designed to operate from a  $V_{IN}$  range of 2.5 V to 5.2 V. This supply must be well regulated and placed as close to the device terminal as possible with the recommended 1 $\mu$ F bypass capacitor. If the supply is located more than a few inches from the device terminals, additional bulk capacitance may be required in addition to the ceramic bypass capacitors. If additional bulk capacitance is required, an electrolytic, tantalum, or ceramic capacitor of 10  $\mu$ F may be sufficient

## ● 14. Layout

For best performance, all traces should be as short as possible, the input and output capacitors should be placed close to the device to minimize the effects that parasitic trace inductances may have on normal and short-circuit operation. The  $V_{IN}$  terminal should be bypassed to ground with low ESR ceramic bypass

capacitors. The typical recommended bypass capacitance is 1µF ceramic with X5R or X7R dielectric. This capacitor should be placed as close to the device terminals as possible. Using wide traces for V<sub>IN</sub>, V<sub>OUT</sub>, and GND will help minimize parasitic electrical effects along with minimizing the case to ambient thermal impedance.

● **14.1 Layout Example**

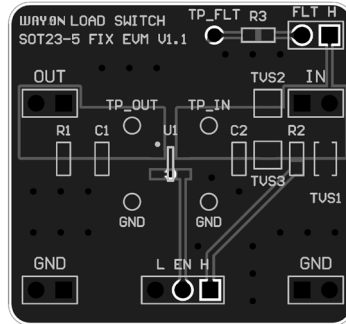

● **15 Evaluation Modules**

Evaluation Modules (EVMs) are available to help evaluate the device performance. We have evaluation modules for different packages, you can contact us by phone or address at the end to get the evaluation module or schematic.

The module names are listed in the table below.

NAME	PACKAGE	EVALUATION MODULE
WP250151T5-B	SOT23-5	WAYON LOAD SWITCH SOT23-5 FIX EVM V1.1

● **16 Naming Conventions**

**WP AB CCC D EE - F**

- WP:** WAYON Protection IC;
- A:** Product Category –2: Load Switch;
- B:** Maximum Output Voltage – 5: <6V;
- CCC:** Maximum Output Current – 015: 150mA;
- D:** Serial number;
- EE:** Package – T5: SOT23-5
- F:** Current Limit Accuracy – B: 20%

● 17 Package Information

SOT 23-5

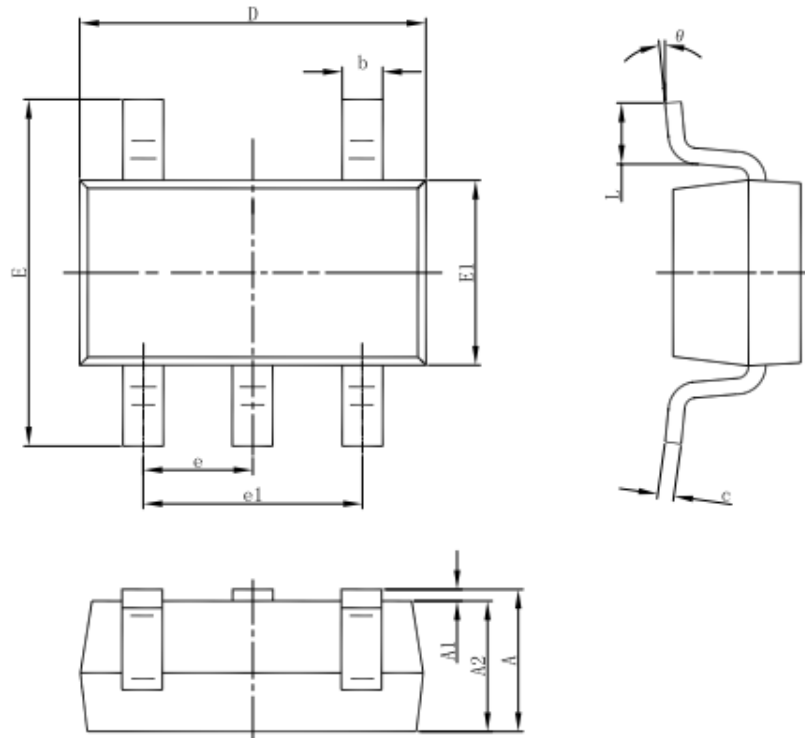

SYMBOL	DIMENSIONS IN MILLIMETERS		
	MIN	NOM	MAX
<b>A</b>	1.050	1.150	1.250
<b>A1</b>	0.000	0.050	0.100
<b>A2</b>	1.050	1.100	1.150
<b>b</b>	0.300	0.400	0.500
<b>c</b>	0.100	0.150	0.200
<b>D</b>	2.820	2.920	3.020
<b>E1</b>	1.500	1.600	1.700
<b>E</b>	2.650	2.800	2.950
<b>e</b>	0.950(BSC)		
<b>e1</b>	1.800	1.900	2.000
<b>L</b>	0.300	0.450	0.600
<b>theta</b>	0°	4°	8°

**● 18 Ordering Information**

PART NUMBER	CURRENT LIMIT	PACKAGE	PACKING QUANTITY	MARKING*
WP250151T5-B	200mA	SOT23-5	3k/Reel	250151 B XXXX

**Contact Information**

No.1001, Shiwan(7) Road, Pudong District, Shanghai, P.R.China.201202

Tel: 86-21-68960674 Fax: 86-21-50757680 Email: market@way-on.com

WAYON website: <http://www.way-on.com>

For additional information, please contact your local Sales Representative.

**WAYON**® is registered trademark of Wayon Corporation.

*Specifications are subject to change without notice.*

*The device characteristics and parameters in this data sheet can and do vary in different applications and actual device performance may vary over time.*

*Users should verify actual device performance in their specific applications.*

单击下面可查看定价，库存，交付和生命周期等信息

[>>WAY-ON\(维安\)](#)