

Power Transient Voltage Suppressor

Features

- 400 watts Peak Pulse Power (10/1000 μ s)
- Unidirectional and Bidirectional Protection
- Fast Response Time: Typically < 1ns
- Excellent Clamping Capability
- Low incremental surge resistance
- Plastic package has Underwriters Laboratory Flammability classification 94V-0
- High temperature soldering guaranteed:260 $^{\circ}$ C/10 seconds/.375", (9.5mm) lead length/5lbs., (2.3kg) tension

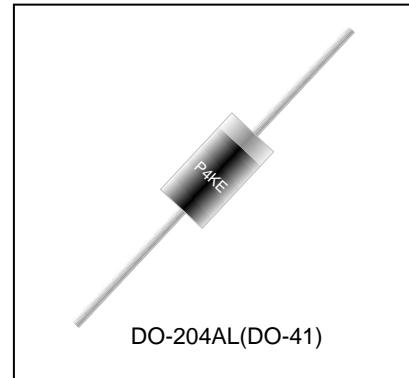

Mechanical Characteristics

- JEDEC DO-204AL molded plastic
- Polarity: Color band denoted cathode except Bipolar
- Marking: Marking Code
- Mounting Position: Any
- RoHS &UL497B Compliant

Applications

- I/O Interfaces
- Power lines
- Telecommunication
- Consumer electronic
- Industrial Electronics
- Computer

| Absolute Maximum Rating | | | |
|--|-----------|--------------------------------|---------------|
| Rating | Symbol | Value | Units |
| Peak Pulse Power ($t_p = 10/1000\mu s$) (see Note1) | P_{PPM} | 400 | Watts |
| Peak pulse current (10/1000 μs) (see Note1) | I_{PPM} | See Electrical Characteristics | A |
| Peak Forward surge current (see Note2) | I_{FSM} | 40 | A |
| Power Dissipation on infinite heat sink $T_L = 50^{\circ}C$ (Fig5) | P_D | 1.5 | W |
| Operating Junction Temperature range | T_J | -55 to + 175 | $^{\circ}C$ |
| Typical Thermal Resistance Junction to Lead | R_{uJL} | 60 | $^{\circ}C/W$ |

Note1: Non-repetitive current pulse, per Fig.3 and derated above $T_A=25^{\circ}C$ per Fig.2.

Note2: Measured on 8.3ms single half sine wave or equivalent square wave, duty cycle=4 per minute maximum.

Note3: $V_F < 3.5V$ for devices of $V_{BR} \leq 200V$ and $V_F < 5.0V$ for devices of $V_{BR} \geq 201V$.

Electrical Characteristics

| Part Number | | Reverse Stand off Voltage V_{RWM} (Volts) | Breakdown Voltage | | Test Current I_T (mA) | Maximum Clamping Voltage $V_C@I_{PP}$ (Volts) | Maximum Peak Pulse Current I_{PP} (Amps) | Maximum Reverse Leakage $I_R@V_{RWM}$ (μ A) |
|-------------|-----------|---|----------------------------|-------|-------------------------------|---|--|--|
| | | | $V_{BR}(\text{Volts})@I_T$ | | | | | |
| UNI-POLAR | BI-POLAR | | MIN | MAX | | | | |
| P4KE6.8A | P4KE6.8CA | 5.80 | 6.45 | 7.14 | 10 | 10.5 | 39.0 | 1000 |
| P4KE7.5A | P4KE7.5CA | 6.40 | 7.13 | 7.88 | 10 | 11.3 | 36.3 | 500 |
| P4KE8.2A | P4KE8.2CA | 7.02 | 7.79 | 8.61 | 10 | 12.1 | 33.9 | 200 |
| P4KE9.1A | P4KE9.1CA | 7.78 | 8.65 | 9.55 | 1 | 13.4 | 30.6 | 50 |
| P4KE10A | P4KE10CA | 8.55 | 9.50 | 10.50 | 1 | 14.5 | 28.3 | 10 |
| P4KE11A | P4KE11CA | 9.40 | 10.50 | 11.60 | 1 | 15.6 | 26.3 | 5 |
| P4KE12A | P4KE12CA | 10.20 | 11.40 | 12.60 | 1 | 16.7 | 24.6 | 5 |
| P4KE13A | P4KE13CA | 11.10 | 12.40 | 13.70 | 1 | 18.2 | 22.5 | 1 |
| P4KE15A | P4KE15CA | 12.80 | 14.30 | 15.80 | 1 | 21.2 | 19.3 | 1 |
| P4KE16A | P4KE16CA | 13.60 | 15.20 | 16.80 | 1 | 22.5 | 18.2 | 1 |
| P4KE18A | P4KE18CA | 15.30 | 17.10 | 18.90 | 1 | 25.5 | 16.1 | 1 |
| P4KE20A | P4KE20CA | 17.10 | 19.00 | 21.00 | 1 | 27.7 | 14.8 | 1 |
| P4KE22A | P4KE22CA | 18.80 | 20.90 | 23.10 | 1 | 30.6 | 13.4 | 1 |
| P4KE24A | P4KE24CA | 20.50 | 22.80 | 25.20 | 1 | 33.2 | 12.3 | 1 |
| P4KE27A | P4KE27CA | 23.10 | 25.70 | 28.40 | 1 | 37.5 | 10.9 | 1 |
| P4KE30A | P4KE30CA | 25.60 | 28.50 | 31.50 | 1 | 41.4 | 9.9 | 1 |
| P4KE33A | P4KE33CA | 28.20 | 31.40 | 34.70 | 1 | 45.7 | 9.0 | 1 |
| P4KE36A | P4KE36CA | 30.80 | 34.20 | 37.80 | 1 | 49.9 | 8.2 | 1 |
| P4KE39A | P4KE39CA | 33.30 | 37.10 | 41.00 | 1 | 53.9 | 7.6 | 1 |
| P4KE43A | P4KE43CA | 36.80 | 40.90 | 45.20 | 1 | 59.3 | 6.9 | 1 |
| P4KE47A | P4KE47CA | 40.20 | 44.70 | 49.40 | 1 | 64.8 | 6.3 | 1 |
| P4KE51A | P4KE51CA | 43.60 | 48.50 | 53.60 | 1 | 70.1 | 5.8 | 1 |
| P4KE56A | P4KE56CA | 47.80 | 53.20 | 58.80 | 1 | 77.0 | 5.3 | 1 |
| P4KE62A | P4KE62CA | 53.00 | 58.90 | 65.10 | 1 | 85.0 | 4.8 | 1 |
| P4KE68A | P4KE68CA | 58.10 | 64.60 | 71.40 | 1 | 92.0 | 4.5 | 1 |
| P4KE75A | P4KE75CA | 64.10 | 71.30 | 78.80 | 1 | 103.0 | 4.0 | 1 |

Electrical Characteristics (Cont.)

| Part Number | | Reverse Stand off Voltage V_{RWM} (Volts) | Breakdown Voltage | | Test Current I_T (mA) | Maximum Clamping Voltage $V_C@I_{PP}$ (Volts) | Maximum Peak Pulse Current I_{PP} (Amps) | Maximum Reverse Leakage $I_R@V_{RWM}$ (μ A) |
|-------------|-----------|---|----------------------------|--------|-------------------------------|---|--|--|
| | | | $V_{BR}(\text{Volts})@I_T$ | | | | | |
| UNI-POLAR | BI-POLAR | | MIN | MAX | | | | |
| P4KE82A | P4KE82CA | 70.10 | 77.90 | 86.10 | 1 | 113.0 | 3.6 | 1 |
| P4KE91A | P4KE91CA | 77.80 | 86.50 | 95.50 | 1 | 125.0 | 3.3 | 1 |
| P4KE100A | P4KE100CA | 85.50 | 95.00 | 105.00 | 1 | 137.0 | 3.0 | 1 |
| P4KE110A | P4KE110CA | 94.00 | 105.00 | 116.00 | 1 | 152.0 | 2.7 | 1 |
| P4KE120A | P4KE120CA | 102.00 | 114.00 | 126.00 | 1 | 165.0 | 2.5 | 1 |
| P4KE130A | P4KE130CA | 111.00 | 124.00 | 137.00 | 1 | 179.0 | 2.3 | 1 |
| P4KE150A | P4KE150CA | 128.00 | 143.00 | 158.00 | 1 | 207.0 | 2.0 | 1 |
| P4KE160A | P4KE160CA | 136.00 | 152.00 | 168.00 | 1 | 219.0 | 1.9 | 1 |
| P4KE170A | P4KE170CA | 145.00 | 162.00 | 179.00 | 1 | 234.0 | 1.8 | 1 |
| P4KE180A | P4KE180CA | 154.00 | 171.00 | 189.00 | 1 | 246.0 | 1.7 | 1 |
| P4KE200A | P4KE200CA | 171.00 | 190.00 | 210.00 | 1 | 274.0 | 1.5 | 1 |
| P4KE220A | P4KE220CA | 185.00 | 209.00 | 231.00 | 1 | 328.0 | 1.3 | 1 |
| P4KE250A | P4KE250CA | 214.00 | 237.00 | 263.00 | 1 | 344.0 | 1.2 | 1 |
| P4KE300A | P4KE300CA | 256.00 | 285.00 | 315.00 | 1 | 414.0 | 1.0 | 1 |
| P4KE350A | P4KE350CA | 300.00 | 332.00 | 368.00 | 1 | 482.0 | 0.85 | 1 |
| P4KE400A | P4KE400CA | 342.00 | 380.00 | 420.00 | 1 | 548.0 | 0.75 | 1 |
| P4KE440A | P4KE440CA | 376.00 | 418.00 | 462.00 | 1 | 602.0 | 0.68 | 1 |
| P4KE480A | P4KE480CA | 408.00 | 456.00 | 504.00 | 1 | 658.0 | 0.61 | 1 |
| P4KE510A | P4KE510CA | 434.00 | 485.00 | 535.00 | 1 | 698.0 | 0.57 | 1 |
| P4KE530A | P4KE530CA | 477.00 | 503.50 | 556.50 | 1 | 725.0 | 0.55 | 1 |
| P4KE540A | P4KE540CA | 486.00 | 513.00 | 567.00 | 1 | 740.0 | 0.54 | 1 |
| P4KE550A | P4KE550CA | 495.00 | 522.50 | 577.50 | 1 | 760.0 | 0.52 | 1 |

For bidirectional type VR of 10 volts and less, the IR limit is double.

For parts without A, the VBR is $\pm 10\%$ and VC is 5% higher than with A parts.

Typical Characteristics

Figure 1: Peak Pulse Power Rating Curve

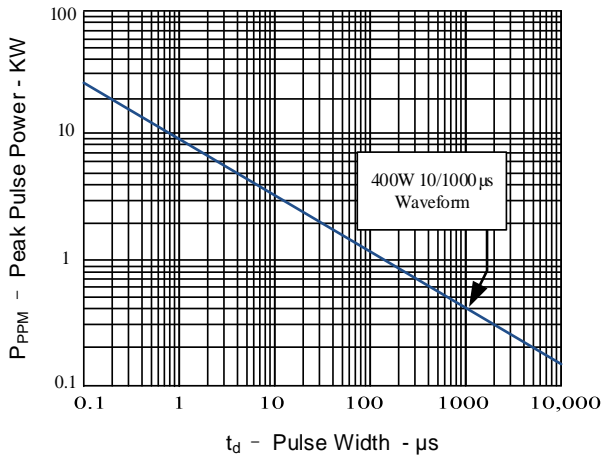

Figure 2: Pulse Derating Curve

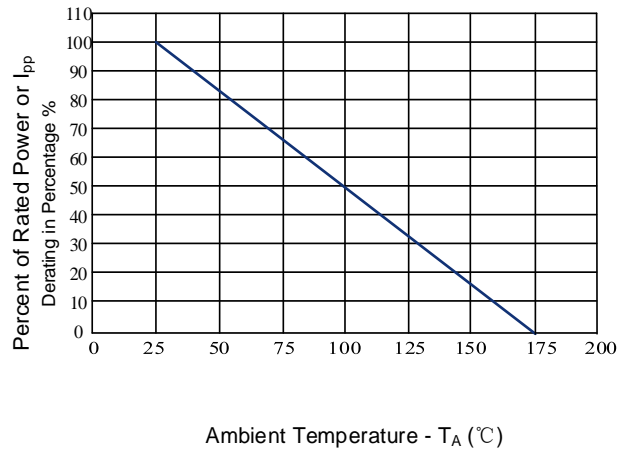

Figure 3: Pulse Waveform

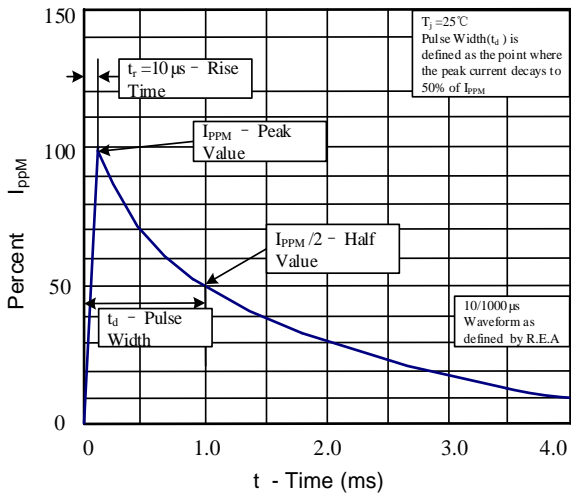

Figure 4: Typical Junction Capacitance

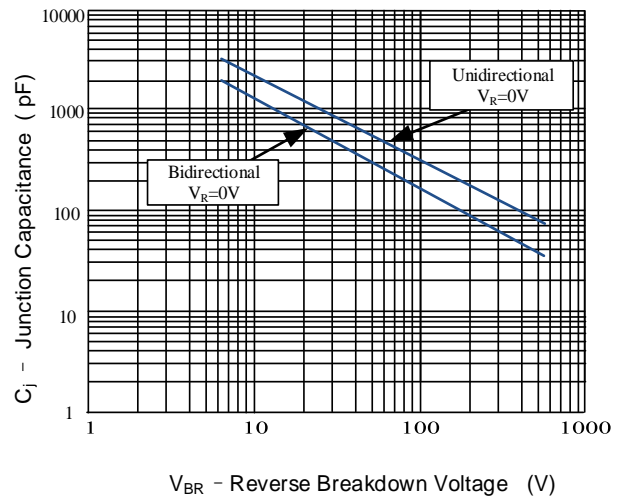

Figure 5: Steady State Power Dissipation Derating Curve

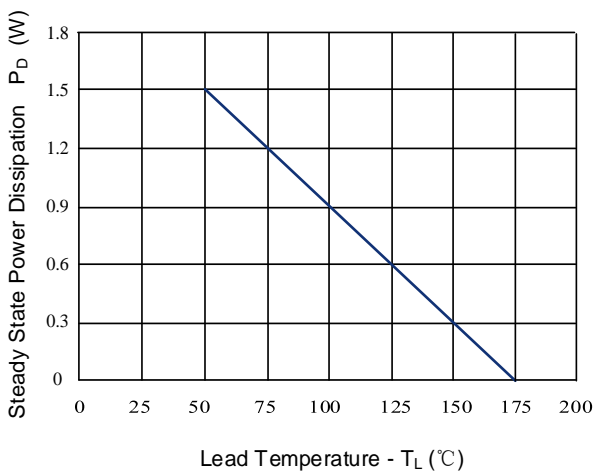
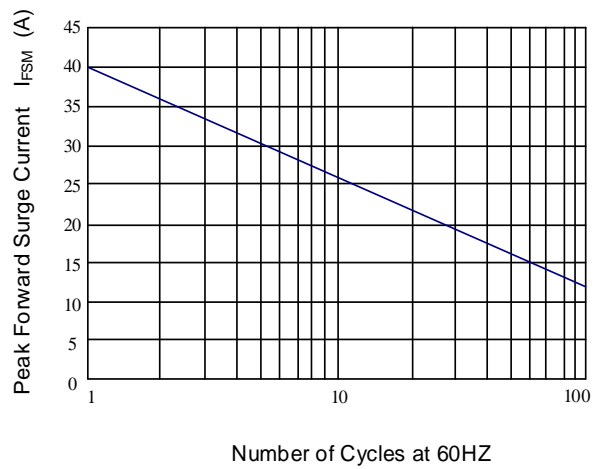
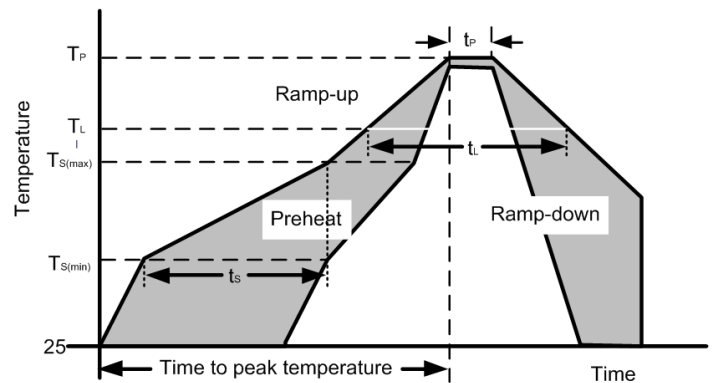

Figure 6: Maximum Non-Repetitive Forward Surge Current Only Unidirectional



Soldering Parameters

| Condition | | |
|--|----------------------------------|-------------------------|
| Pre Heat | Temperature min ($T_{S(min)}$) | 150°C |
| | Temperature max ($T_{S(max)}$) | 200°C |
| | Time (min to max) (t_s) | 60-190 s |
| Average ramp up rate (Liquidus Temp) (T_L) to peak | | 3°C/s max |
| Ts(max) to TL - Ramp-up Rate | | 3°C/s max |
| Reflow | Temperature (T_L) (Liquidus) | 217°C |
| | Temperature (t_L) | 60-150 s |
| Peak Temperature (T_P) | | 260 ^{+0/-5} °C |
| Time within actual peak Temperature (t_p) | | 20-40 s |
| Ramp-down Rate | | 5°C/s max |
| Time 25°C to peak Temperature (T_P) | | 8 minutes max |
| Do not exceed | | 260°C |



Outline Drawing - DO-204AL(DO-41)

| Ref. (mm) | Millimeters | |
|-----------|-------------|------|
| | Min. | Max. |
| A | 25.40 | - |
| B | 4.10 | 5.20 |
| C | 0.71 | 0.86 |
| D | 2.00 | 2.70 |

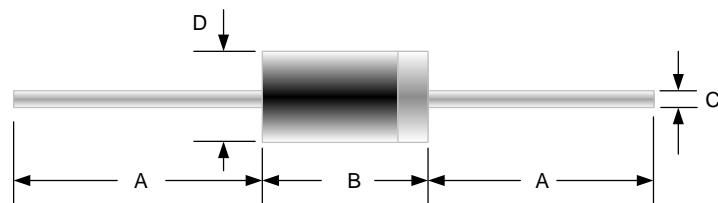

DO-204AL(DO-41)

Part Numbering System

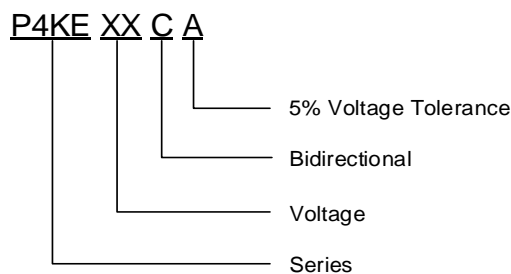

Part Marking System

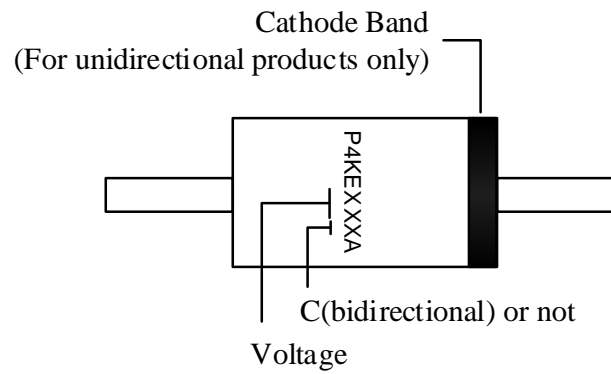

Package Information

| Package Type | Description | Quantity (pcs) |
|--------------|-------------|----------------|
| DO-204AL | Tape & Box | 3000 |

CONTACT INFORMATION

No.1001, Shiwan(7) Road, Pudong District, Shanghai, P.R.China.201207

Tel: +86-21-68969993 Fax: 86-21-50757680 Email: market@way-on.com

WAYON website: <http://www.way-on.com>

For additional information, please contact your local Sales Representative.

WAYON® is registered trademarks of Wayon Corporation.

Specifications are subject to change without notice.

The device characteristics and parameters in this data sheet can and do vary in different applications and actual device performance may vary over time. Users should verify actual device performance in their specific applications.

单击下面可查看定价，库存，交付和生命周期等信息

[>>WAY-ON\(维安\)](#)